

SAMSUNG

VRF

Technical Data Book

**DVM S Eco for Europe
(R410A, 50Hz, HP)**



Model : AM***FXMDEH/EU, AM***FXMDGH/EU, AM***KXMDGH/EU, AM***KXMDEH/EU, AM***MXMDGH/EU

History

Version	Modification	Date	Remark
Ver.1.0	Release DVM S Eco TDB	'13. 03. 02	
Ver.1.1	Modified the unit of air flow rate : CFM → CMM (Specification)	'15. 03. 12	
Ver.1.2	Max pipe length modified(equivalent length) for 8HP : 100 → 130m	'15. 04. 07	
Ver.1.3	Release total DVM S Eco TDB	'15. 04. 30	
Ver.1.4	Add Note information in Specification regarding EU F-Gas regulation.	'15. 06. 17	
Ver.1.5	Modified the Sound Power Graph.	'15. 09. 18	
Ver.1.6	Modified the dimensional drawing.	'16. 05. 11	
Ver.2.0	Update all contents	'16. 09. 30	
Ver. 3.0	Add 4/5HP Model (1 Fan Outdoor Unit)	'16. 10. 30	
Ver. 3.1	Add tCO _{2e} data (Specifications)	'16. 12. 09	
Ver. 3.2	Add 8HP New Model (AM080MXMDGH)	'16. 12. 25	
Ver. 3.3	Revise Max. total capacity of AM040KXMDEH/EU in the specification page.	'17. 07. 21	
Ver. 3.31	Modify the Accessory Compatibility table for MCU kit(P147)	'17. 09. 13	
Ver. 3.4	Revised the Capacity Correction heating data (P108~111)	'18. 03. 06	
Ver. 3.5	Updated note of Capacity Correction page	'19. 03. 15	

Nomenclature

Outdoor Unit

Model Name

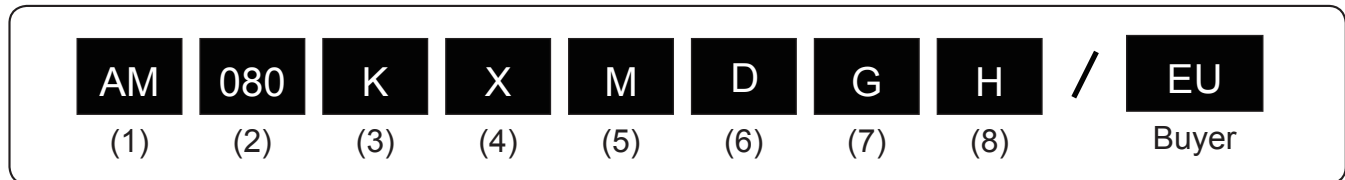

(1) Classification

AM	DVM
----	-----

(2) Capacity

x1/10 HP (3 digits)

(3) Version

F	2013
H	2014
J	2015
K	2016
M	2017

(4) Product Type

X	Outdoor Unit
N	Indoor Unit

(5) Product Notation

M	DVM S Eco
---	-----------

(6) Feature

A	Standard + General Temp.+ MODULE
H	High EER + Low Temp + Module
D	STANDARD+GENERAL Temp. + NON MODULE

(7) Rating Voltage

E	1Ø, 220~240V, 50Hz
G	3Ø, 380~415V, 50Hz
H	3Ø, 380V, 60Hz

(8) Mode

H	Heat Pump
R	Heat Recovery

Features & Benefits

Experience ultimate comfort at home or work with powerful yet economical performance

The VRF-based Samsung DVM S Eco system air conditioner combines world-class energy efficiency and economy to deliver outstanding performance in a space-saving design. Supporting up to nine indoor units, DVM S Eco is a perfectly optimized cooling system for residences and smaller buildings. Its lightweight, small-scale build enables easy, low-cost installation, while its uniquely quiet design ensures soothing comfort and maximum efficiency. Plus, the DVM S Eco line offers a wide range of capacities to suit every need.

Big capacity. Big choice.

World's largest capacity and most compact side-discharge outdoor unit, which also offers a high level of energy efficiency. It's ideal for homes or business that need plenty of coverage, but only have limited space.

Best in class capacity

Provides more coverage, but takes up less space. It has the largest capacity in its class of 14HP, enabling you to create a small footprint VRF solution. So it's ideal for installation in places with limited space.



The Samsung DVM S Eco system air conditioner delivers optimal comfort, efficiency and performance with features such as:

- **First-rate energy efficiency.** Save on energy consumption and operational costs with high-performance compressor technology.
- **Low noise levels.** Enjoy a more peaceful home or work environment with quiet operation, thanks to a streamlined fan design.
- **Various installation options.** Ease installation and minimize effort with a small footprint and a variety of size options.

Compact design for extra flexibility

The most compact air conditioner in its class, making it very easy and economical to install and operate without compromising on performance. It also leaves plenty of extra space that can be used for other purposes.



Advanced performance & energy efficiency

Its advanced technology radically improves performance and reduces wasted energy. It includes an innovative Digital Inverter Compressor, an optimized heat exchanger with corrugated fins and highly efficient fans.



Features & Benefits

Improved reliability in cold conditions

Featuring advanced refrigerant control technology, its flash injection provides improved heating performance at -25°C . And it continues to perform even at lower temperatures, for reliable comfort when it's freezing.



Control your cooling anywhere

An optional Wi-Fi Kit lets you remotely control indoor units using a smartphone App*. Anytime and anywhere you can turn them on and off, select the operating mode and temperature, and utilize their other functions.

* Available on iPhones and Android devices. A Wi-Fi connection is required.



Drive down costs and energy use with unmatched efficiency

Samsung DVM S Eco delivers world-class energy efficiency for today's eco- and budget-conscious businesses. Using advanced compressor technology, it offers industry-leading COP, which means exceptional heating and cooling performance at a nominal cost.

Energy-efficient compression

DVM S Eco features innovative inverter compressor, which provides a higher cooling and heating COP than that of a conventional model. The result is one of the most efficient air conditioning systems on the market and a smart investment for cost-conscious businesses



Enjoy minimal noise levels for maximum comfort

With its superior design, DVM S Eco offers a comforting environment undisturbed by bothersome noise levels typical of standard air conditioning systems. Residents can enjoy a more restful night and employees can increase focus levels with less disturbance.

Ultra-quiet operation

By producing less noise than conventional models, the DVM S ECO imposes fewer distractions on residential and working environments. Its compact, unimposing design and specially shaped fan blades help reduce sound levels up to 5 decibels, creating a more pleasant. Plus, its quiet operation during the night time creates a restful environment with a reduced noise level of 2 - 8 dB.

* Available in heating mode by external contact signal

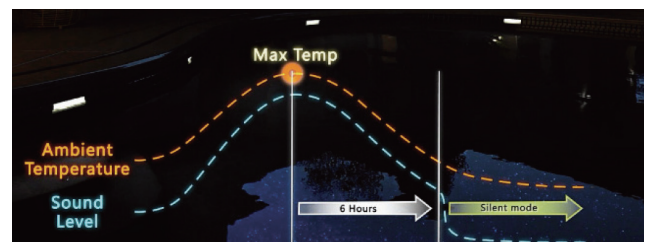

Features & Benefits

Connects more, fits more

Has a 4 way piping system, with connections at the front, side, and rear, and a 160m piping length, so it fits into many more places, including small or narrow spaces, and is easier to install and maintain.

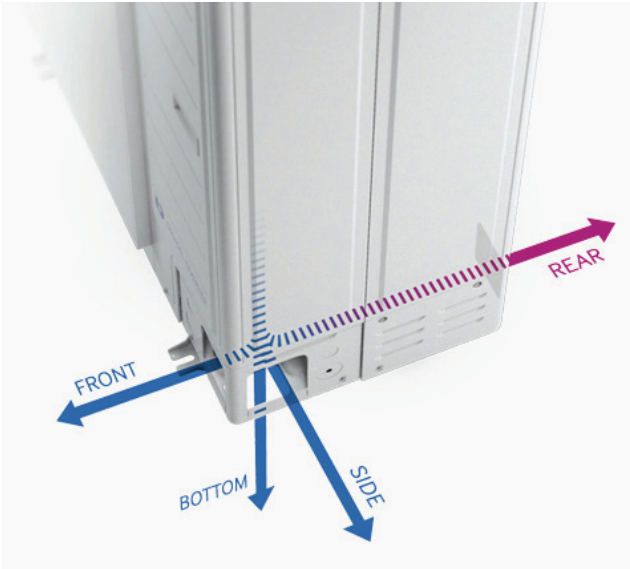

Flexibly install it almost anywhere

Provides the flexibility to be installed almost anywhere, regardless of its location or distance from the building. It has a piping length of up to 160m (525ft) and can reach up to a height of 50m (164ft).

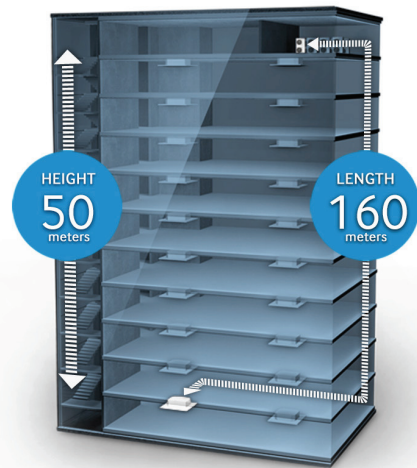

Efficient space use

With a single DVM S Eco (14HP) outdoor unit, users can experience the same performance level as that of two 6+8 HP outdoor units.

The streamlined high-performance unit reduces installation space, so users can optimize more compact areas and minimize installation effort.

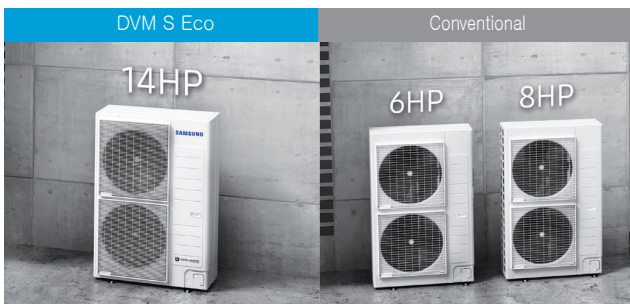





Contents

1. Line up	8
2. Specification	10
3. Electrical Characteristics	18
4. Dimensional Drawing	19
5. Center of Gravity	23
6. Electrical Wiring Diagram	27
7. Sound Data	33
8. Operation Range	40
9. Piping Diagram	43
10. Capacity Table	48
11. Capacity Correction	108
12. Installation	116
13. Accessory	140

1. Line up















































































1-1. Outdoor units

Capacity (HP)		4, 5, 6	8	10, 12, 14
Shape				
Model	1phase	AM040FXMDEH/EU AM050FXMDEH/EU AM060FXMDEH/EU		
	3phase	AM040FXMDGH/EU AM050FXMDGH/EU AM060FXMDGH/EU	AM080FXMDGH/EU AM080MXMDGH/EU	AM100KXMDGH/EU AM120KXMDGH/EU AM140KXMDGH/EU

Capacity (HP)		4, 5
Shape		
Model	1phase	AM040KXMDEH/EU AM050KXMDEH/EU

1. Line up

1-2. Indoor units

Model	Capacity (kW)																
	1.5	1.7	2.2	2.8	3.6	4.5	5.6	6.0	7.1	9.0	11.2	12.8	14.0	22.0	28.0	500 CMH	1000 CMH
Slim 1Way CST (JSF)																	
2Way CST																	
4Way CST																	
4Way CST S (600X600)																	
360 CST																	
Floor Standing Unit																	
Slim Duct																	
MSP Duct																	
HSP Duct																	
Ceiling																	
Console																	
Boracay																	
Boracay (with EEV)																	
ERV Plus																	

2. Specification

Outdoor unit

Type				DVM S Eco	DVM S Eco
Model Name				AM040KXMDEH/EU	AM050KXMDEH/EU
Power Supply			Φ, #, V, Hz	1, 2, 220-240, 50	1, 2, 220-240, 50
Mode			-	HEAT PUMP	HEAT PUMP
Performance	HP		HP	4	5
	Capacity	Cooling	kW	12.1	14.0
			Btu/h	41,200	48,000
		Heating	kW	12.1	14.0
			Btu/h	41,200	48,000
Maximum number of connectable indoor units			ea	6	8
	Total capacity of the connected Indoor Units	Min.	kW	5.6	7.0
		Max.	kW	15.7	18.2
Power	Power Input	Cooling ¹⁾	kW	3.6	4.0
		Heating ²⁾		2.9	3.4
	Current Input	Cooling ¹⁾	A	17.5	19.5
		Heating ²⁾		14.0	16.5
	Current	Minimum Ssc value	MVA	-	-
		MCA	A	24	27
MFA		A	32	40	
COP	Cooling ¹⁾		W/W	3.36	3.50
	Heating ²⁾		W/W	4.17	4.12
	ESEER		W/W	7.25	6.71
Casing	Material	Cabinet	-	EGI steel plate	EGI steel plate
		Base	-	GI steel plate	GI steel plate
Heat exchanger	Type		-	Fin & Tube	Fin & Tube
	Material	Fin	-	Al	Al
		Tube	-	Cu	Cu
	Fin Treatment		-	Anti-corrosion	Anti-corrosion
Compressor	Type		-	Twin BLDC Rotary	Twin BLDC Rotary
	Output		kW × n	4.12	4.12
	Model Name		-	UG5T450FUEJX	UG5T450FUEJX
	Oil	Type	-	PVE	PVE
		Initial Charge	cc	1,700	1,700
Fan	Type		-	Propeller	Propeller
	Discharge direction		-	Horizontal	Horizontal
	Quantity		ea	1	1
	Air Flow Rate		m ³ /min	64	70
			l/s	1,067	1,167
	External Static Pressure	Max.	mmAq	3	3
Pa			29.4	29.4	
Fan Motor	Model		-	BLDC Motor	BLDC Motor
	Output x n		W	125 x 1	139 x 1

2. Specification

Type				DVM S Eco	DVM S Eco	
Model Name				AM040KXMDEH/EU	AM050KXMDEH/EU	
Piping Connections	Liquid Pipe	Type		Braze connection	Braze connection	
		Φ, mm		9.52	9.52	
		Φ, inch		3/8"	3/8"	
	Gas Pipe	Type		Braze connection	Braze connection	
		Φ, mm		15.88	15.88	
		Φ, inch		5/8"	5/8"	
	Discharge Gas Pipe	Φ, mm		-	-	
		Φ, inch		-	-	
	Heat insulation			-	Both liquid and gas pipes	Both liquid and gas pipes
	Piping length (ODU-IDU)	Max. [Equiv.]	m	50 (65)	50 (65)	
	Piping length (1st Branch-IDU)	Max.	m	40	40	
	Total piping length (System)	Max.	m	150	150	
	Level difference (ODU in highest position)	Max.	m	30	30	
Level difference (IDU in highest position)	Max.	m	25	25		
Level difference (IDU-IDU)	Max.	m	15	15		
Wiring connections ³⁾	Communication	Minimum	mm ²	0.75	0.75	
		Remark	-	F1,F2	F1,F2	
Refrigerant	Type			R410A	R410A	
	Factory Charging		kg / tCO ₂ e	2.0 / 4.18	2.5 / 5.22	
Sound ⁴⁾	Sound Pressure	Cooling	dB(A)	52	55	
		Heating		54	57	
	Sound Power			73	75	
External Dimension	Net Weight		kg	79.0	83.5	
	Shipping Weight		kg	84.5	89.0	
	Net Dimensions (WxHxD)		mm	940 x 998 x 330	940 x 998 x 330	
	Shipping Dimensions (WxHxD)		mm	1009 x 1124 x 419	1009 x 1124 x 419	
Operating Temp. Range	Cooling		°C	-5.0 ~ 48.0	-5.0 ~ 48.0	
	Heating		°C	-20.0 ~ 24.0	-20.0 ~ 24.0	

NOTE

- Specifications may be subject to change without prior notice.
 - 1) Cooling capacities are based on;
 - Indoor temperature : 27°C DB, 19°C WB
 - Outdoor temperature : 35°C DB, 24°C WB, Equivalent refrigerant piping : 7.5m, Level differences : 0m
 - 2) Heating capacities are based on;
 - Indoor temperature : 20°C DB, 15°C WB
 - Outdoor temperature : 7°C DB, 6°C WB, Equivalent refrigerant piping : 7.5m, Level differences : 0m
 - 3) Select wire size based on the value of MCA
 - 4) Sound power level is an absolute value that a sound source generates.
 Sound pressure level is a relative value, depending on the distance and acoustic environment.
 Sound values are obtained in an anechoic room.
 Sound values of multi combination are theoretical values based on sound results of individual installed units.
 - 5) These products contain R410A(GWP=2,088) which is fluorinated greenhouse gas.

2. Specification

Type				DVM S Eco	DVM S Eco	DVM S Eco	DVM S Eco
Model Name				AM040FXMDEH/EU	AM040FXMDGH/EU	AM050FXMDEH/EU	AM050FXMDGH/EU
Power Supply			Φ, #, V, Hz	1,2,220-240,50	3,4,380-415,50	1,2,220-240,50	3,4,380-415,50
Mode				-	HEAT PUMP	HEAT PUMP	HEAT PUMP
Performance	HP	HP		4	4	5	5
		Capacity	Cooling	kW	12.1	12.1	14.0
	Btu/h			41,300	41,300	47,800	47,800
	Heating		kW	13.5	13.5	16.0	16.0
			Btu/h	46,100	46,100	54,600	54,600
Maximum number of connectable indoor units				ea	6	6	8
Power	Total capacity of the connected Indoor Units	Min.	kW	5.6	5.6	7.0	7.0
			Max.	kW	15.7	15.7	18.2
	Power Input	Cooling ¹⁾	kW	2.89	2.99	3.69	3.69
				Heating ²⁾	3.02	3.02	3.61
	Current Input	Cooling ¹⁾	A	14.0	4.8	17.9	6.2
				Heating ²⁾	15.1	5.0	17.2
	Current	Minimum Ssc value	MVA	-	3.3	-	3.3
			MCA	A	22.0	10.0	24.0
MFA			A	32	20	32	20
COP	Cooling ¹⁾		W/W	4.19	4.05	3.79	3.79
	Heating ²⁾		W/W	4.47	4.47	4.43	4.43
	ESEER		W/W	7.57	7.57	6.91	6.91
Casing	Material	Cabinet	-	EGI steel plate	EGI steel plate	EGI steel plate	EGI steel plate
		Base	-	GI steel plate	GI steel plate	GI steel plate	GI steel plate
Heat exchanger	Type		-	Fin & Tube	Fin & Tube	Fin & Tube	Fin & Tube
	Material	Fin	-	Al	Al	Al	Al
		Tube	-	Cu	Cu	Cu	Cu
	Fin Treatment		-	Anti-corrosion	Anti-corrosion	Anti-corrosion	Anti-corrosion
Compressor	Type		-	Twin BLDC Rotary	Twin BLDC Rotary	Twin BLDC Rotary	Twin BLDC Rotary
	Output		kW × n	(4.12) × 1	(4.12) × 1	(4.12) × 1	(4.12) × 1
	Model Name		-	UG5T450FUEJXSG x 1	UG5T450FUFJXSG x 1	UG5T450FUEJXSG x 1	UG5T450FUFJXSG x 1
	Oil	Type	-	PVE	PVE	PVE	PVE
		Initial Charge	cc	1700	1700	1700	1700
Fan	Type		-	Propeller	Propeller	Propeller	Propeller
	Discharge direction		-	Horizontal	Horizontal	Horizontal	Horizontal
	Quantity		ea	2	2	2	2
	Air Flow Rate		m ³ /min	100	100	100	100
			l/s	1,666.67	1,666.67	1,666.67	1,666.67
	External Static Pressure	Max.	mmAq	3	3	3	3
Pa			29.4	29.4	29.4	29.4	
Fan Motor	Model		-	BLDC Motor	BLDC Motor	BLDC Motor	BLDC Motor
	Output x n		W	125 x 2	125 x 2	125 x 2	125 x 2

2. Specification

Type			DVM S Eco	DVM S Eco	DVM S Eco	DVM S Eco	
Model Name			AM040FXMDEH/EU	AM040FXMDGH/EU	AM050FXMDEH/EU	AM050FXMDGH/EU	
Piping Connections	Liquid Pipe	Type	Braze connection	Braze connection	Braze connection	Braze connection	
		Φ, mm	9.52	9.52	9.52	9.52	
		Φ, inch	3/8"	3/8"	3/8"	3/8"	
	Gas Pipe	Type	Braze connection	Braze connection	Braze connection	Braze connection	
		Φ, mm	15.88	15.88	15.88	15.88	
		Φ, inch	5/8"	5/8"	5/8"	5/8"	
	Discharge Gas Pipe	Φ, mm	-	-	-	-	
		Φ, inch	-	-	-	-	
	Heat insulation		-	Both liquid and gas pipes	Both liquid and gas pipes	Both liquid and gas pipes	Both liquid and gas pipes
	Piping length (ODU-IDU)	Max. [Equiv.]	m	150 (175)	150 (175)	150 (175)	150 (175)
	Piping length (1st Branch-IDU)	Max.	m	40	40	40	40
	Total piping length (System)	Max.	m	300	300	300	300
	Level difference (ODU in highest position)	Max.	m	50	50	50	50
Level difference (IDU in highest position)	Max.	m	40	40	40	40	
Level difference (IDU-IDU)	Max.	m	15	15	15	15	
Wiring connections ³⁾	Communication	Minimum	mm ²	0.75	0.75	0.75	0.75
		Remark	-	F1,F2	F1,F2	F1,F2	F1,F2
Refrigerant	Type		R410A	R410A	R410A	R410A	
	Factory Charging		kg / tCO ₂ e	3.2 / 6.68	3.2 / 6.68	3.2 / 6.68	3.2 / 6.68
Sound ⁴⁾	Sound Pressure	Cooling	dB(A)	50	50	51	51
		Heating		52	52	53	53
	Sound Power			66	66	67	67
External Dimension	Net Weight		kg	100	100	100	100
	Shipping Weight		kg	105	105	105	105
	Net Dimensions (WxHxD)		mm	940 x 1,210 x 330	940 x 1,210 x 330	940 x 1,210 x 330	940 x 1,210 x 330
	Shipping Dimensions (WxHxD)		mm	995 x 1,388 x 426	995 x 1,388 x 426	995 x 1,388 x 426	995 x 1,388 x 426
Operating Temp. Range	Cooling		°C	-5.0 ~ 48.0	-5.0 ~ 48.0	-5.0 ~ 48.0	-5.0 ~ 48.0
	Heating		°C	-20.0 ~ 26.0	-20.0 ~ 26.0	-20.0 ~ 26.0	-20.0 ~ 26.0

NOTE

- Specifications may be subject to change without prior notice.
 - 1) Cooling capacities are based on;
 - Indoor temperature : 27°C DB, 19°C WB
 - Outdoor temperature : 35°C DB, 24°C WB, Equivalent refrigerant piping : 7.5m, Level differences : 0m
 - 2) Heating capacities are based on;
 - Indoor temperature : 20°C DB, 15°C WB
 - Outdoor temperature : 7°C DB, 6°C WB, Equivalent refrigerant piping : 7.5m, Level differences : 0m
 - 3) Select wire size based on the value of MCA
 - 4) Sound power level is an absolute value that a sound source generates.
 Sound pressure level is a relative value, depending on the distance and acoustic environment.
 Sound values are obtained in an anechoic room.
 Sound values of multi combination are theoretical values based on sound results of individual installed units.
 - 5) These products contain R410A(GWP=2,088) which is fluorinated greenhouse gas.

2. Specification

Type				DVM S Eco	DVM S Eco	DVM S Eco	DVM S Eco
Model Name				AM060FXMDEH/EU	AM060FXMDGH/EU	AM080FXMDGH/EU	AM080MXMDGH/EU
Power Supply			Φ, #, V, Hz	1,2,220-240,50	3,4,380-415,50	3,4,380-415,50	3,4,380-415,50
Mode				-	HEAT PUMP	HEAT PUMP	HEAT PUMP
Performance	HP	HP		6	6	8	8
		Capacity	Cooling	kW	15.5	15.5	22.4
	Btu/h			52,900	52,900	76,400	76,400
	Heating		kW	18.0	18.0	25.0	22.4
			Btu/h	61,400	61,400	85,300	76,400
Maximum number of connectable indoor units				ea	9	9	13
Power	Total capacity of the connected Indoor Units	Min.	kW	7.8	7.8	11.2	11.2
			Max.	kW	20.2	20.2	29.1
	Power Input	Cooling ¹⁾	kW	4.31	4.31	5.72	6.90
				Heating ²⁾	4.39	4.39	4.88
	Current Input	Cooling ¹⁾	A	21	7.3	9.66	11.7
				Heating ²⁾	20.2	6.9	8.24
	Current	Minimum Ssc value	MVA	-	3.3	3.4	3.4
			MCA	A	32.0	12.0	18.0
MFA			A	40.0	20	25.0	25.0
COP	Cooling ¹⁾		W/W	3.6	3.6	3.92	3.25
	Heating ²⁾		W/W	4.1	4.1	5.12	3.86
	ESEER		W/W	6.45	6.45	9.22	7.46
Casing	Material	Cabinet	-	EGI steel plate	EGI steel plate	EGI steel plate	EGI steel plate
		Base	-	GI steel plate	GI steel plate	GI steel plate	GI steel plate
Heat exchanger	Type		-	Fin & Tube	Fin & Tube	Fin & Tube	Fin & Tube
	Material	Fin	-	Al	Al	Al	Al
		Tube	-	Cu	Cu	Cu	Cu
	Fin Treatment		-	Anti-corrosion	Anti-corrosion	Anti-corrosion	Anti-corrosion
Compressor	Type		-	Twin BLDC Rotary	Twin BLDC Rotary	Inverter Scroll	Twin BLDC Rotary
	Output		kW × n	(4.12) × 1	(4.12) × 1	(4.96) × 1	4.92 × 1
	Model Name		-	UG5T450FUEJXSG x1	UG5T450FUFJXSG x1	DS-GB052FAVADO x1	UG5T520FUBJX
	Oil	Type	-	PVE	PVE	PVE	PVE
		Initial Charge	cc	1700	1700	2800	1,700
Fan	Type		-	Propeller	Propeller	Propeller	Propeller
	Discharge direction		-	Horizontal	Horizontal	Horizontal	Horizontal
	Quantity		ea	2	2	2	2
	Air Flow Rate		m ³ /min	100	100	135	135
			l/s	1,666.67	1,666.67	2,250.00	2,250
	External Static Pressure	Max.	mmAq	3	3	3	3
Pa			29.4	29.4	29.4	29.4	
Fan Motor	Model		-	BLDC Motor	BLDC Motor	BLDC Motor	BLDC Motor
	Output x n		W	125 x 2	125 x 2	139 x 2	139 x 2

2. Specification

Type			DVM S Eco	DVM S Eco	DVM S Eco	DVM S Eco	
Model Name			AM060FXMDEH/EU	AM060FXMDGH/EU	AM080FXMDGH/EU	AM080MXMDGH/EU	
Piping Connections	Liquid Pipe	Type	Braze connection	Braze connection	Braze connection	Braze connection	
		Φ, mm	9.52	9.52	9.52	9.52	
		Φ, inch	3/8"	3/8"	3/8"	3/8"	
	Gas Pipe	Type	Braze connection	Braze connection	Braze connection	Braze connections	
		Φ, mm	19.05	19.05	19.05	19.05	
		Φ, inch	3/4"	3/4"	3/4"	3/4"	
	Discharge Gas Pipe	Φ, mm	-	-	-	-	
		Φ, inch	-	-	-	-	
	Heat insulation	-	Both liquid and gas pipes	Both liquid and gas pipes	Both liquid and gas pipes	Both liquid and gas pipes	
	Piping length (ODU-IDU)	Max. [Equiv.]	m	150 (175)	150 (175)	100 (130)	100 (130)
	Piping length (1st Branch-IDU)	Max.	m	40	40	40	40
	Total piping length (System)	Max.	m	300	300	300	300
	Level difference (ODU in highest position)	Max.	m	50	50	30	30
Level difference (IDU in highest position)	Max.	m	40	40	30	30	
Level difference (IDU-IDU)	Max.	m	15	15	30	30	
Wiring connections ³⁾	Communication	Minimum	mm ²	0.75	0.75	0.75	0.75
		Remark	-	F1,F2	F1,F2	F1,F2	F1,F2
Refrigerant	Type		R410A	R410A	R410A	R410A	
	Factory Charging	kg / tCO ₂ e	3.3 / 6.89	3.3 / 6.89	3.3 / 6.89	3.7 / 7.73	
Sound ⁴⁾	Sound Pressure	Cooling	dB(A)	53	53	56	59
		Heating		55	55	58	59
	Sound Power		69	69	74	77	
External Dimension	Net Weight	kg	103	103	135	115	
	Shipping Weight	kg	108	108	145	125	
	Net Dimensions (WxHxD)	mm	940 x 1,210 x 330	940 x 1,210 x 330	940 x 1,420 x 330	940 x 1,420 x 330	
	Shipping Dimensions (WxHxD)	mm	995 x 1,388 x 426	995 x 1,388 x 426	995 x 1,578 x 426	995 x 1,578 x 426	
Operating Temp. Range	Cooling	°C	-5.0 ~ 48.0	-5.0 ~ 48.0	-5.0 ~ 48.0	-5.0 ~ 48.0	
	Heating	°C	-20.0 ~ 26.0	-20.0 ~ 26.0	-20.0 ~ 24.0	-20.0 ~ 24.0	

NOTE

- Specifications may be subject to change without prior notice.
 - 1) Cooling capacities are based on;
 - Indoor temperature : 27°C DB, 19°C WB
 - Outdoor temperature : 35°C DB, 24°C WB, Equivalent refrigerant piping : 7.5m, Level differences : 0m
 - 2) Heating capacities are based on;
 - Indoor temperature : 20°C DB, 15°C WB
 - Outdoor temperature : 7°C DB, 6°C WB, Equivalent refrigerant piping : 7.5m, Level differences : 0m
 - 3) Select wire size based on the value of MCA
 - 4) Sound power level is an absolute value that a sound source generates.
 Sound pressure level is a relative value, depending on the distance and acoustic environment.
 Sound values are obtained in an anechoic room.
 Sound values of multi combination are theoretical values based on sound results of individual installed units.
 - 5) These products contain R410A(GWP=2,088) which is fluorinated greenhouse gas.

2. Specification

Type				DVM S Eco	DVM S Eco	DVM S Eco
Model Name				AM100KXMDGH/EU	AM120KXMDGH/EU	AM140KXMDGH/EU
Power Supply			Φ, #, V, Hz	3,4,380-415,50	3,4,380-415,50	3,4,380-415,50
Mode			-	HEAT PUMP	HEAT PUMP	HEAT PUMP
Performance	HP		HP	10	12	14
	Capacity	Cooling	kW	28.0	33.5	40.0
			Btu/h	95,500	114,300	136,500
		Heating	kW	31.5	37.5	45.0
			Btu/h	107,500	128,000	153,500
Maximum number of connectable indoor units			ea	18	21	26
Power	Total capacity of the connected Indoor Units	Min.	kW	14.0	16.8	20.0
		Max.	kW	36.4	43.6	52.0
	Power Input	Cooling ¹⁾	kW	7.29	8.77	10.59
		Heating ²⁾		6.74	7.81	9.88
	Current Input	Cooling ¹⁾	A	11.51	13.74	16.48
		Heating ²⁾		10.58	12.23	15.55
	Current	Minimum Ssc value	MVA	4.6	5.1	5.9
MCA		A	21.5	23.5	32.0	
MFA		A	30.0	30.0	40.0	
COP	Cooling ¹⁾		W/W	3.84	3.82	3.78
	Heating ²⁾		W/W	4.67	4.79	4.55
	ESEER		W/W	7.09	6.94	6.83
Casing	Material	Cabinet	-	EGI steel plate	EGI steel plate	EGI steel plate
		Base	-	GI steel plate	GI steel plate	GI steel plate
Heat exchanger	Type		-	Fin & Tube	Fin & Tube	Fin & Tube
	Material	Fin	-	Al	Al	Al
		Tube	-	Cu	Cu	Cu
	Fin Treatment		-	Anti-corrosion	Anti-corrosion	Anti-corrosion
Compressor	Type		-	Inverter Scroll	Inverter Scroll	Inverter Scroll
	Output		kW × n	(5.18) x 1	(6.39) x 1	(6.76) x 1
	Model Name		-	DS-GB052FAVB x 1	DS-GB066FAVB x 1	DS-GB070FAVA x 1
	Oil	Type	-	PVE	PVE	PVE
		Initial Charge	cc	2300	2300	2300
Fan	Type		-	Propeller	Propeller	Propeller
	Discharge direction		-	Horizontal	Horizontal	Horizontal
	Quantity		ea	2	2	2
	Air Flow Rate		m ³ /min	165	166	180
			l/s	2750.00	2,766.67	3,000.00
	External Static Pressure	Max.	mmAq	3	3	3
Pa			29.4	29.4	29.4	
Fan Motor	Model		-	BLDC Motor	BLDC Motor	BLDC Motor
	Output x n		W	244 x 2	244 x 2	244 x 2

2. Specification

Type				DVM S Eco	DVM S Eco	DVM S Eco	
Model Name				AM100KXMDGH/EU	AM120KXMDGH/EU	AM140KXMDGH/EU	
Piping Connections	Liquid Pipe	Type		Braze connection	Braze connection	Braze connection	
		Φ, mm		9.52	12.70	12.70	
		Φ, inch		3/8"	1/2"	1/2"	
	Gas Pipe	Type		Braze connection	Braze connection	Braze connection	
		Φ, mm		22.22	28.58	28.58	
		Φ, inch		7/8"	1 1/8"	1 1/8"	
	Discharge Gas Pipe	Φ, mm		-	-	-	
		Φ, inch		-	-	-	
	Heat insulation			-	Both liquid and gas pipes	Both liquid and gas pipes	Both liquid and gas pipes
	Piping length (ODU-IDU)	Max. [Equiv.]	m	160 (185)	160 (185)	160 (185)	
	Piping length (1st Branch-IDU)	Max.	m	40	40	40	
	Total piping length (System)	Max.	m	300	300	300	
	Level difference (ODU in highest position)	Max.	m	50	50	50	
Level difference (IDU in highest position)	Max.	m	40	40	40		
Level difference (IDU-IDU)	Max.	m	50	50	50		
Wiring connections ³⁾	Communication	Minimum	mm ²	0.75	0.75	0.75	
		Remark	-	F1,F2	F1,F2	F1,F2	
Refrigerant	Type			R410A	R410A	R410A	
	Factory Charging		kg / tCO ₂ e	3.7 / 7.73	4.3 / 8.98	4.8 / 10.02	
Sound ⁴⁾	Sound Pressure	Cooling	dB(A)	58	59	62	
		Heating		60	61	64	
	Sound Power			74	76	79	
External Dimension	Net Weight		kg	145	155	162	
	Shipping Weight		kg	158	168	175	
	Net Dimensions (WxHxD)		mm	940 x 1,630 x 460	940 x 1,630 x 460	940 x 1,630 x 460	
	Shipping Dimensions (WxHxD)		mm	1,020 x 1,820 x 575	1,020 x 1,820 x 575	1,020 x 1,820 x 575	
Operating Temp. Range	Cooling		°C	-5.0 ~ 52.0	-5.0 ~ 52.0	-5.0 ~ 52.0	
	Heating		°C	-25.0 ~ 24.0	-25.0 ~ 24.0	-25.0 ~ 24.0	

NOTE

- Specifications may be subject to change without prior notice.
 - Cooling capacities are based on;
 - Indoor temperature : 27°C DB, 19°C WB
 - Outdoor temperature : 35°C DB, 24°C WB, Equivalent refrigerant piping : 7.5m, Level differences : 0m
 - Heating capacities are based on;
 - Indoor temperature : 20°C DB, 15°C WB
 - Outdoor temperature : 7°C DB, 6°C WB, Equivalent refrigerant piping : 7.5m, Level differences : 0m
 - Select wire size based on the value of MCA
 - Sound power level is an absolute value that a sound source generates.
 Sound pressure level is a relative value, depending on the distance and acoustic environment.
 Sound values are obtained in an anechoic room.
 Sound values of multi combination are theoretical values based on sound results of individual installed units.
 - These products contain R410A(GWP=2,088) which is fluorinated greenhouse gas.

3. Electrical Characteristics

Capacity		Model	Power Supply				Voltage Range		Running Current [A]		Current [A]		ODU Fan Motor
HP	kW		Φ	#	Hz	Voltage	Min. (-10%)	Max. (+10%)	Cooling	Heating	MCA	MFA	kW
4	12.1	AM040KXMDEH/EU	1	2	50	220~240	198	264	17.50	14.00	24.0	32.0	0.125
5	14.0	AM050KXMDEH/EU	1	2	50	220~240	198	264	19.50	16.50	27.0	40.0	0.139
4	12.1	AM040FXMDEH/EU	1	2	50	220~240	198	264	14.00	15.10	22.0	32.0	0.250
4	12.1	AM040FXMDGH/EU	3	4	50	380~415	342	456	4.80	5.00	10.0	20.0	0.250
5	14.0	AM050FXMDEH/EU	1	2	50	220~240	198	264	17.90	17.20	24.0	32.0	0.250
5	14.0	AM050FXMDGH/EU	3	4	50	380~415	342	456	6.20	6.00	12.0	20.0	0.250
6	15.5	AM060FXMDEH/EU	1	2	50	220~240	198	264	21.00	20.20	32.0	40.0	0.250
6	15.5	AM060FXMDGH/EU	3	4	50	380~415	342	456	7.30	6.90	12.0	20.0	0.250
8	22.4	AM080FXMDGH/EU	3	4	50	380~415	342	456	9.66	8.24	18.0	25.0	0.278
8	22.4	AM080MXMDGH/EU	3	4	50	380~415	342	456	11.70	9.50	18.4	25.0	0.278
10	28.0	AM100KXMDGH/EU	3	4	50	380~415	342	456	11.51	10.58	21.5	30.0	0.488
12	33.4	AM120KXMDGH/EU	3	4	50	380~415	342	456	13.74	12.23	23.5	30.0	0.488
14	40.0	AM140KXMDGH/EU	3	4	50	380~415	342	456	16.48	15.55	32.0	40.0	0.488

 **NOTE**

- MCA : Minimum circuit amperes
- MFA : Maximum fuse amperes
- Select wire size based on the value of MCA

4. Dimensional Drawing

AM040KXMDEH/EU, AM050KXMDEH/EU

Units : mm [inches]

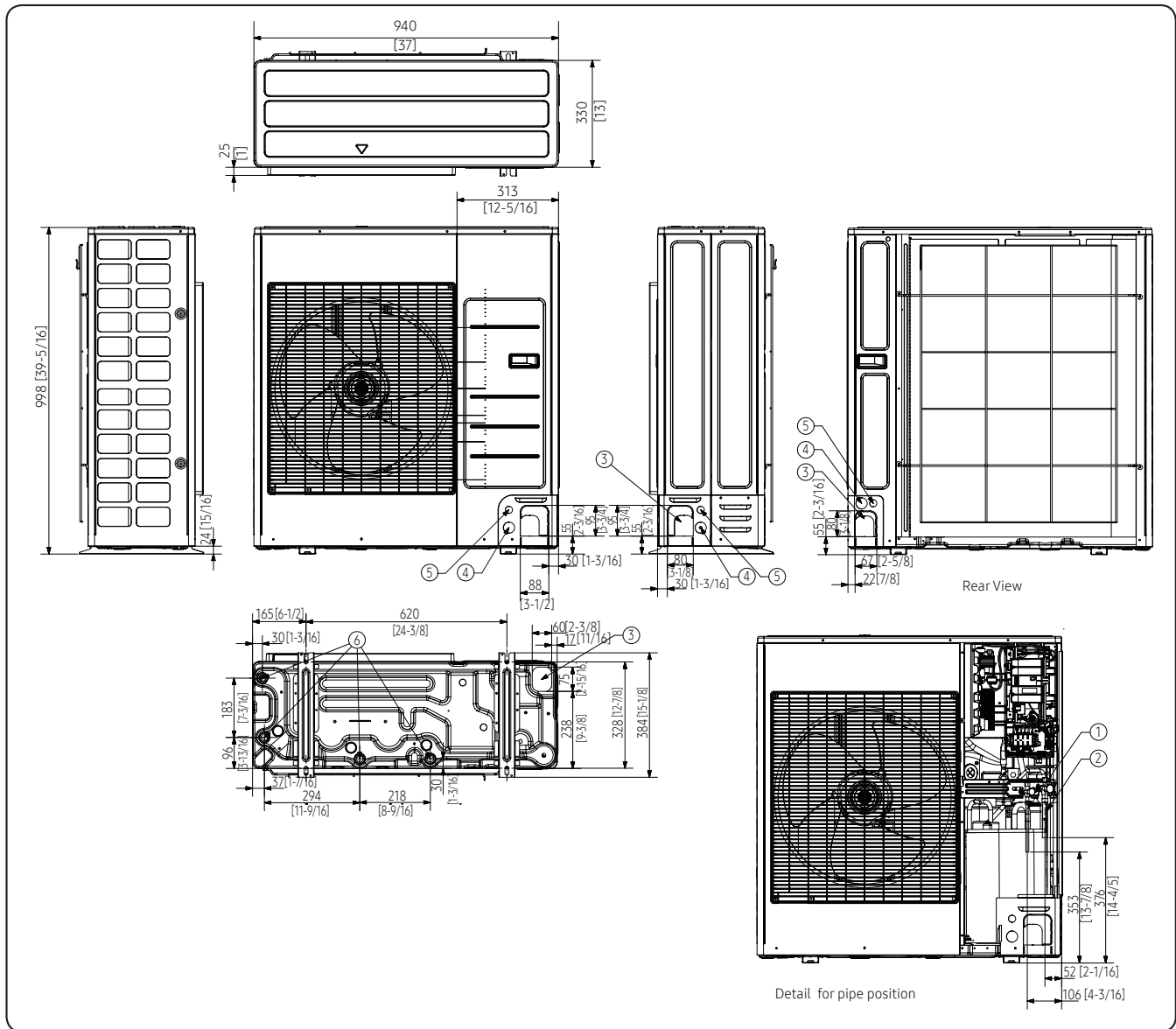

NO	Name	Description
		4 / 5 HP
1	Refrigerant liquid pipe	Φ9.52 (Φ3/8)
2	Refrigerant gas pipe	Φ15.88 (Φ5/8)
3	Knockout hole for pipe intake	Front / Side / Rear / Bottom
4	Power wiring conduits	Front / Side / Rear, Φ34 (Φ1-3/8)
5	Communication wiring conduits	Front / Side / Rear, Φ22 (Φ7/8)
6	Drain holes	Connect with the provided drain plug.

4. Dimensional Drawing

AM040FXMD*H/EU, AM050FXMD*H/EU, AM060FXMD*H/EU

Units : mm [inches]

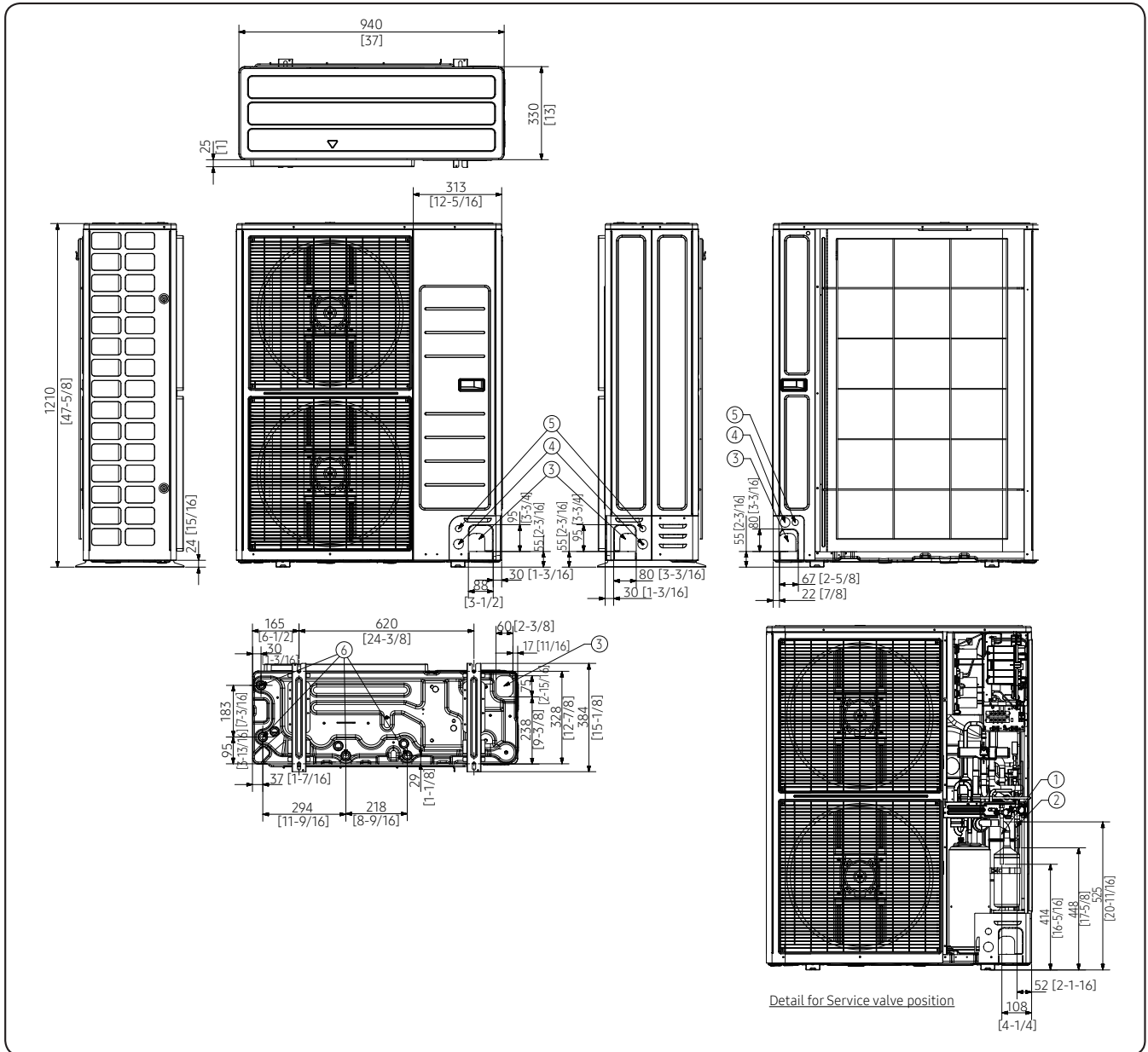

NO	Name	Description	
		4 / 5 HP	6 HP
1	Refrigerant liquid pipe	Φ9.52 (Φ3/8)	
2	Refrigerant gas pipe	Φ15.88 (Φ5/8)	Φ19.05 (Φ3/4)
3	Knockout hole for pipe intake	Front / Side / Rear / Bottom	
4	Power wiring conduits	Front / Side / Rear, Φ34 (Φ1-3/8)	
5	Communication wiring conduits	Front / Side / Rear, Φ22 (Φ7/8)	
6	Drain holes	Connect with the provided drain plug.	

4. Dimensional Drawing

AM080*XMDGH/EU

Units : mm [inches]

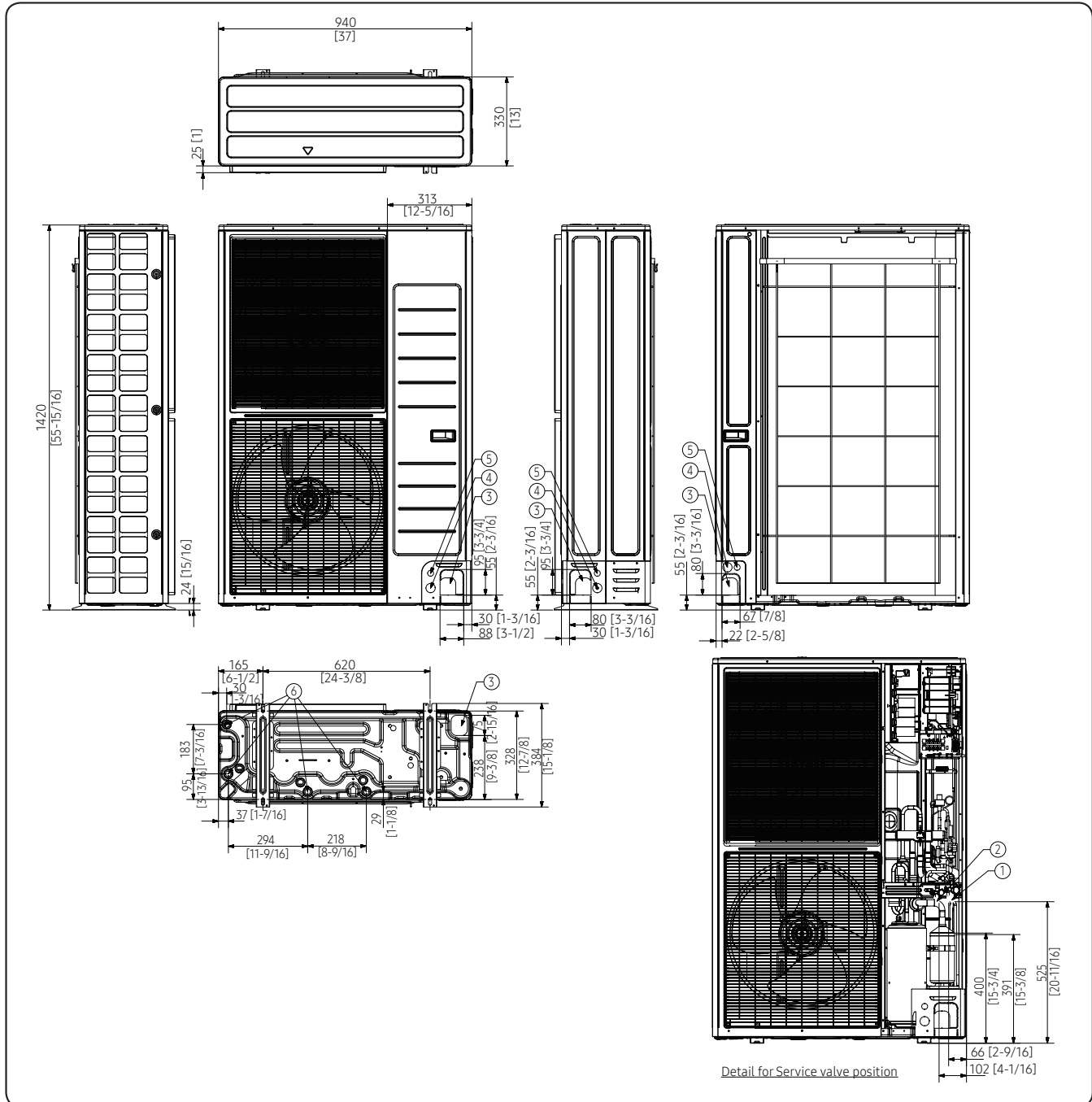

NO	Name	Description
1	Refrigerant gas pipe	Φ19.05 (Φ3/4)
2	Refrigerant liquid pipe	Φ9.52 (Φ3/8)
3	Knockout hole for pipe intake	Front / Side / Rear / Bottom
4	Power wiring conduits	Front / Side / Rear, Φ34 (Φ1-3/8)
5	Communication wiring conduits	Front / Side / Rear, Φ22 (Φ7/8)
6	Drain holes	Connect with the provided drain plug.

4. Dimensional Drawing

AM100KXMDGH/EU, AM120KXMDGH/EU, AM140KXMDGH/EU

Units : mm [inches]

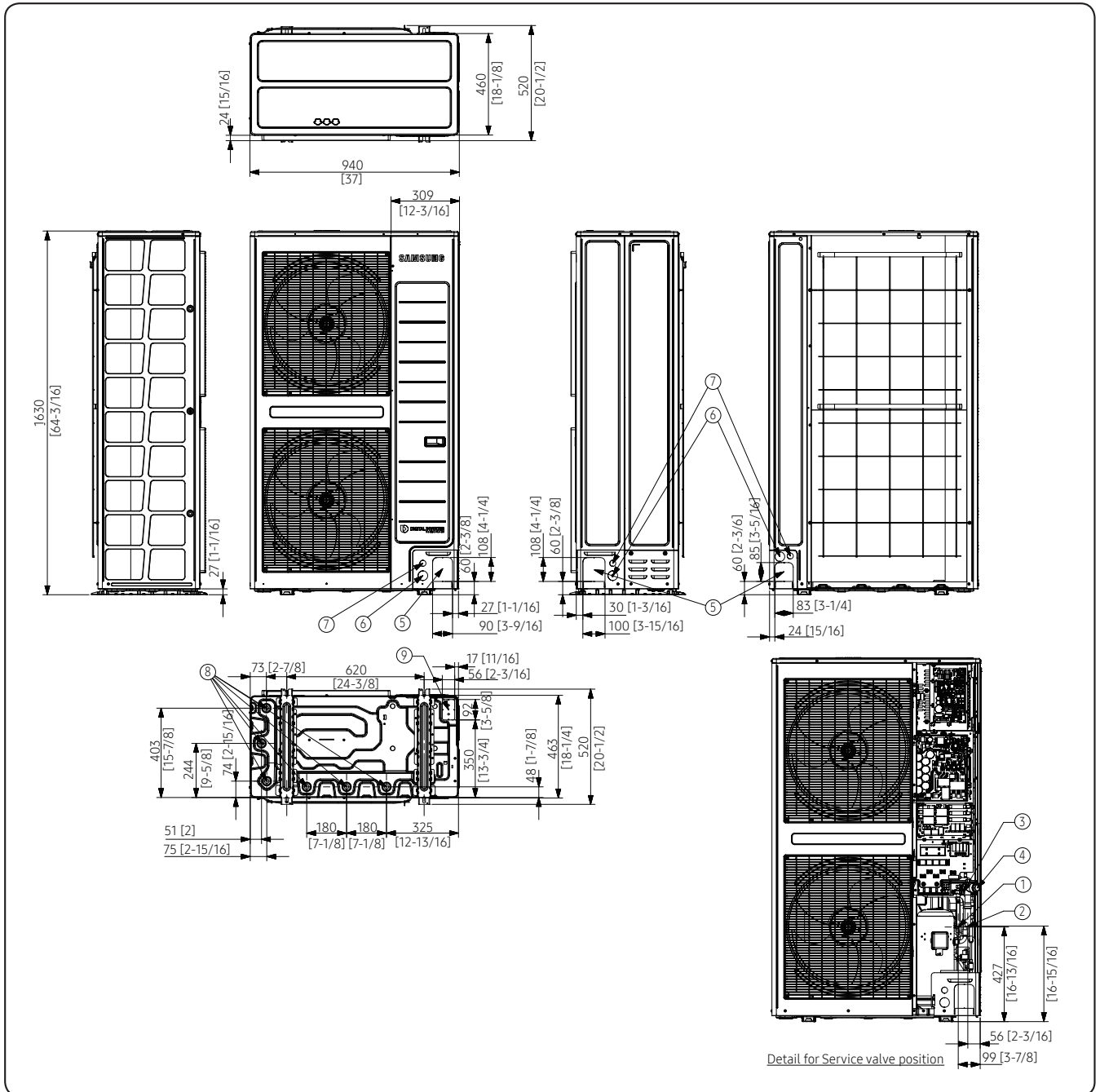

NO	Name	Description	
		10 HP	12 / 14 HP
1	Refrigerant liquid pipe	Φ9.52 (Φ3/8)	Φ12.7 (Φ1/2)
2	Refrigerant gas pipe	Φ22.22 (Φ7/8)	Φ28.58 (Φ1-1/8)
3	Service Valve (Gas)		
4	Service Valve (Liquid)		
5	Knockout hole for pipe intake	Front / Side / Rear	
6	Power wiring conduits	Φ44 (Φ1-3/4)	
7	Communication wiring conduits	Φ28 (Φ1-1/8)	
8	Drain holes	Connect with the provided drain plug.	
9	Knockout hole for pipe intake	Bottom	

5. Center of Gravity

AM040KXMDEH/EU, AM050KXMDEH/EU

Units : mm [inches]

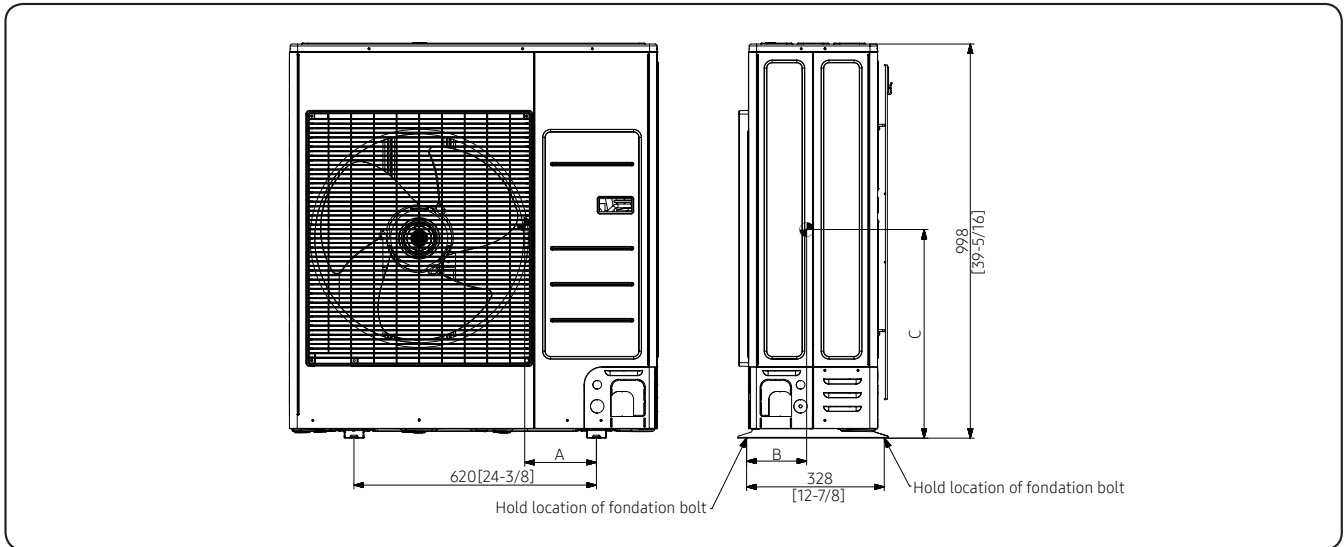

Model	A	B	C
AM040KXMD×H××	205	160	445
AM050KXMD×H××	205	160	445

5. Center of Gravity

AM040FXMD*H/EU, AM050FXMD*H/EU, AM060FXMD*H/EU

Units : mm [inches]

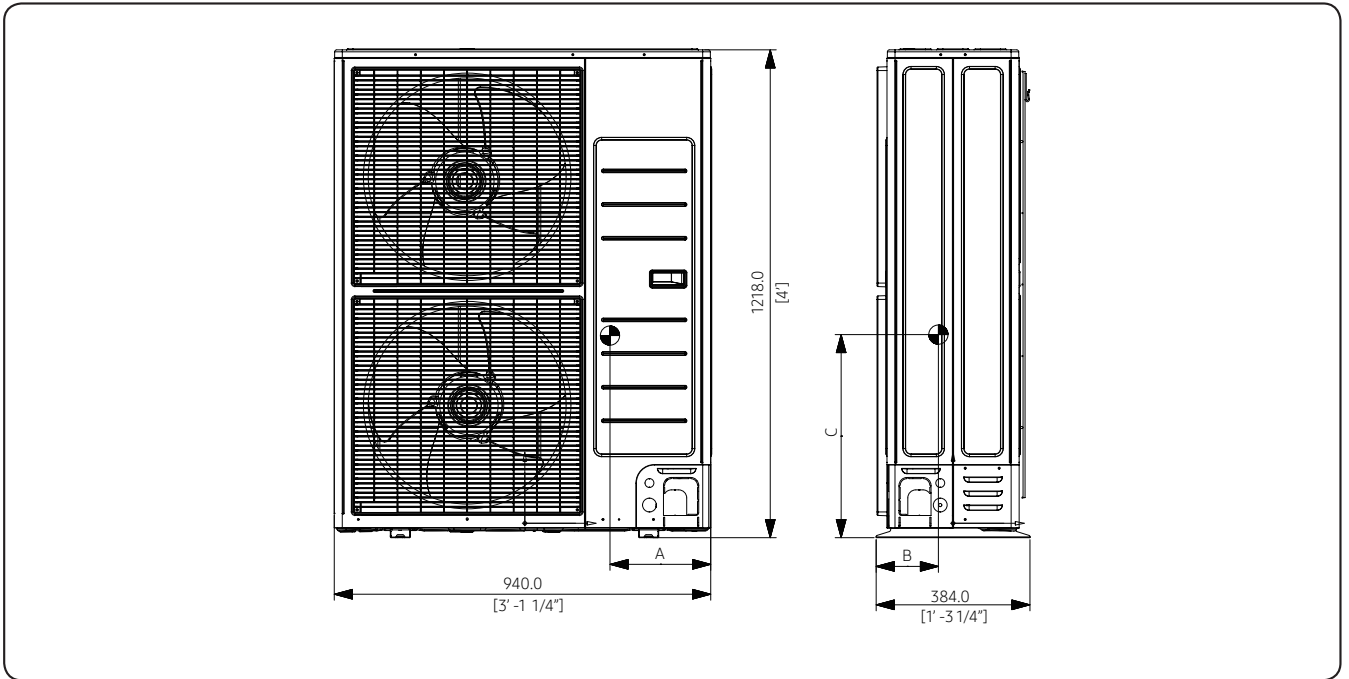

Model	A	B	C
AM040FXMD*H/EU	372	165	557
AM050FXMD*H/EU	372	165	557
AM060FXMD*H/EU	375	172	557

5. Center of Gravity

AM080*XMDGH/EU

Units : mm [inches]

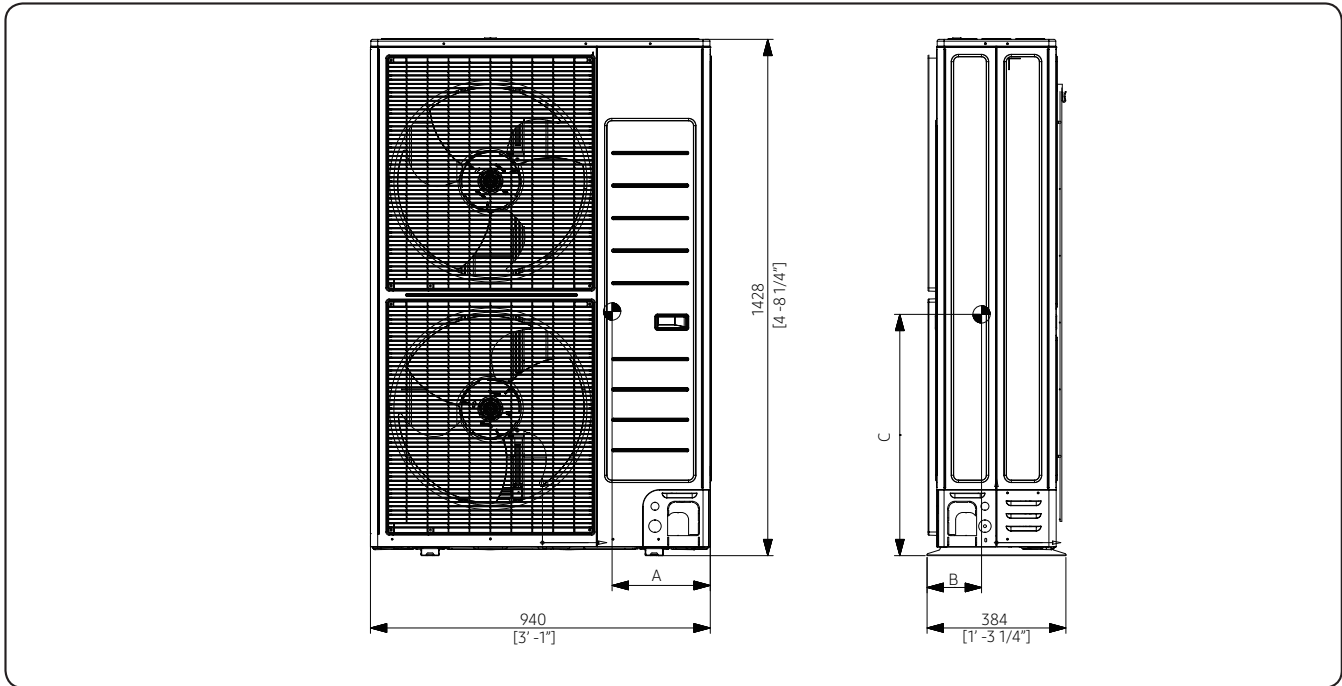

Model	A	B	C
AM080*XMDGH/EU	363	168	653

5. Center of Gravity

AM100KXMDGH/EU, AM120KXMDGH/EU, AM140KXMDGH/EU

Units : mm [inches]

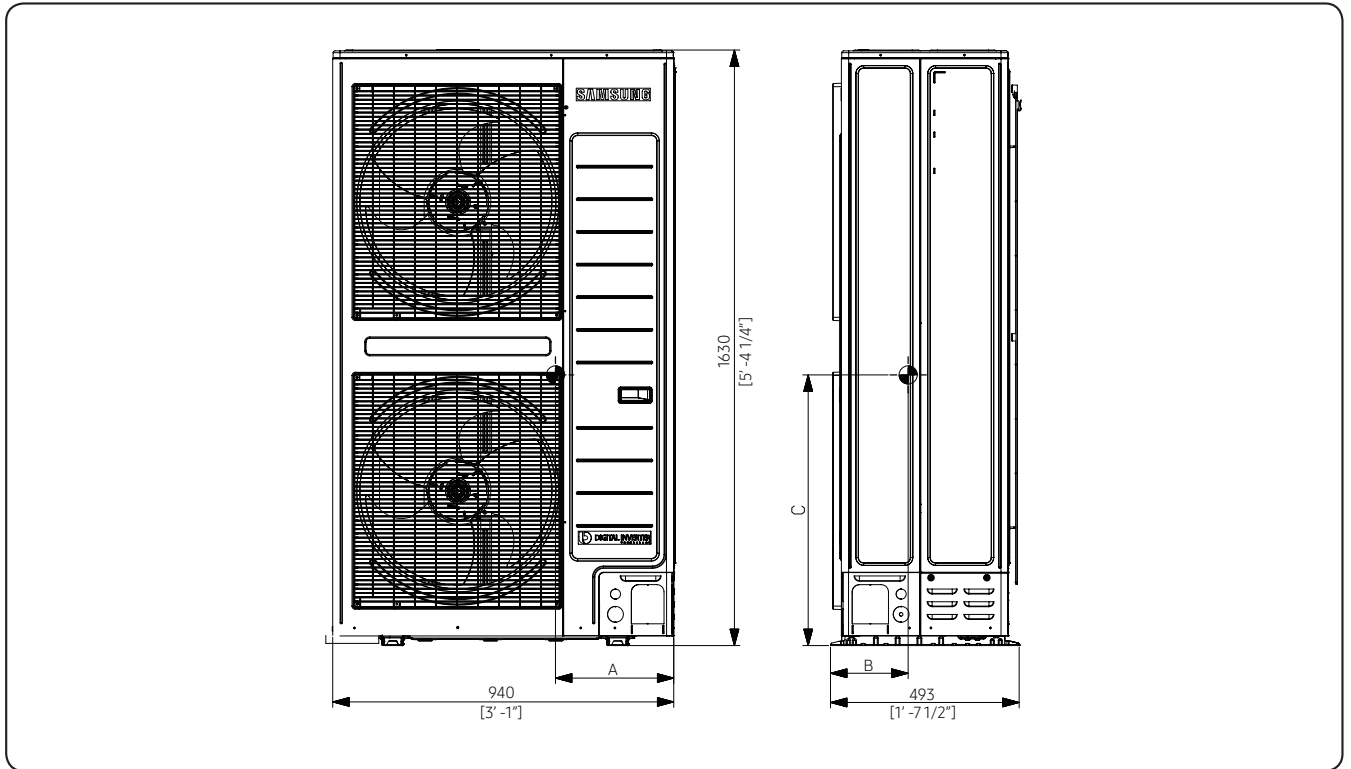

Model	A	B	C
AM100KXMDGH/EU	336	214	746
AM120KXMDGH/EU	336	214	746
AM140KXMDGH/EU	336	214	746

6. Electrical Wiring Diagram

AM040KXMDEH/EU, AM050KXMDEH/EU, AM040FXMDEH/EU, AM050FXMDEH/EU, AM060FXMDEH/EU

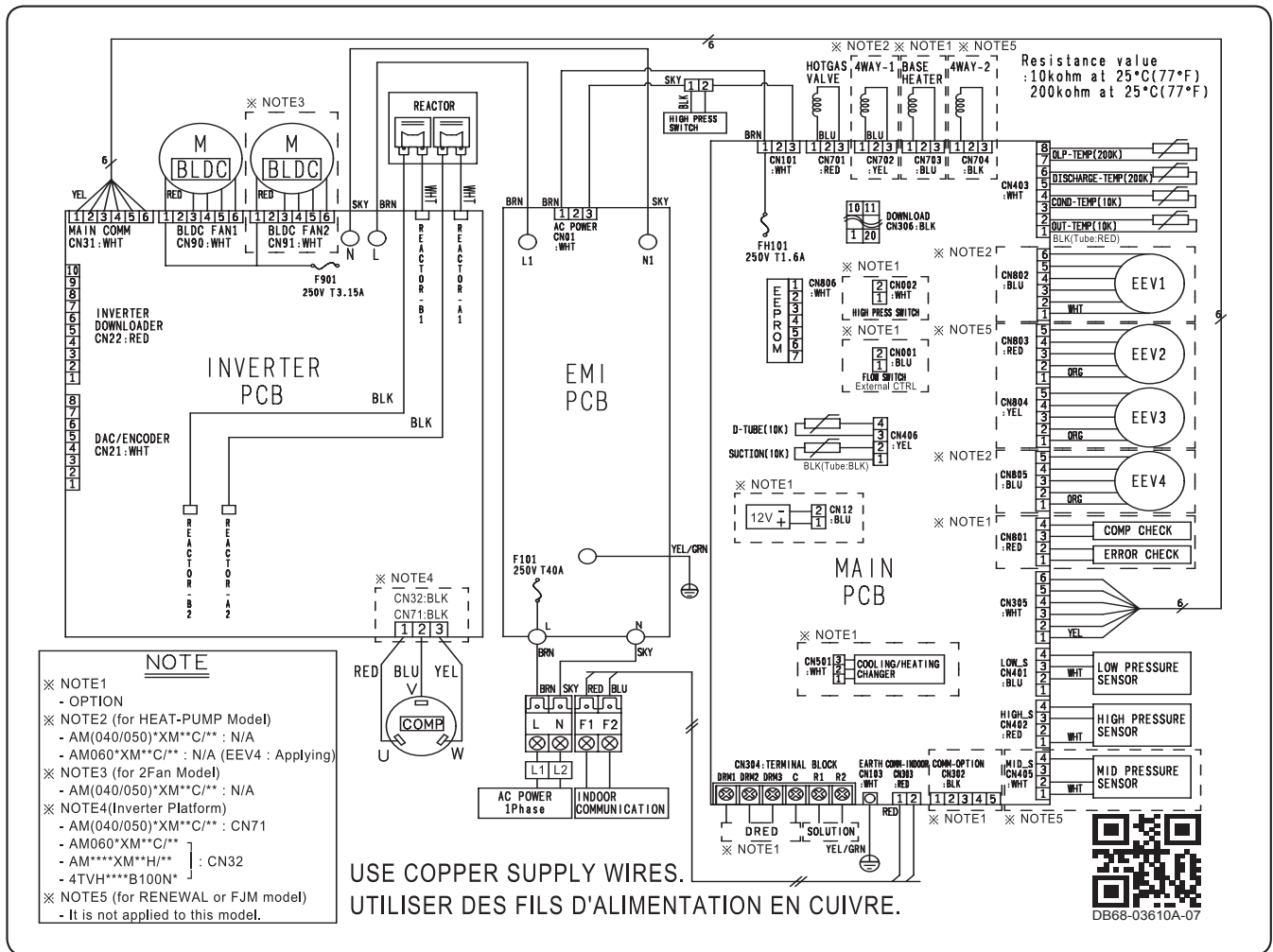

MAIN PCB	Printed circuit board (Main)	4WAY-1 VALVE	Solenoid valve (4WAY)	OLP-TEMP	Thermistor (Liquid)
INVERTER PCB	Printed circuit board (Inverter)	4WAY-2 VALVE	Solenoid valve (4WAY)	DISCHARGE-TEMP	Thermistor (Discharge)
EMI PCB	Printed circuit board (emi1)	EEV	Electronic expansion valve	COND-TEMP	Thermistor (Liquid)
COMP	Motor (Compressor)	HOTGAS VALVE	Solenoid valve (Hotgas-bypass)	LIQUID TEMP	Thermistor (Liquid)
BLDC	Motor (ODU Fan)	HOTGAS VALVE	Solenoid valve (Hotgas-bypass)	OUT-TEMP	Thermistor (Air)
REACTOR	DC_Reactor	250V T40A	FUSE		

NOTE

- This wiring diagram applies only to the outdoor unit.
- Colors blk: black, red: red, blu: blue, wht: white, yel: yellow, brn: brown, sky: skyblue, org: orange, grn: green
- When operating, don't shortcircuit the protection device (High Pressure switch)
- For connection wiring indoor-outdoor transmission F1-F2, outdoor-outdoor transmission OF1-OF2, refer to the installation manual.
- Protective earth(SCREW), : connector, : The wire quantity

6. Electrical Wiring Diagram

AM040FXMDGH/EU, AM050FXMDGH/EU, AM060FXMDGH/EU

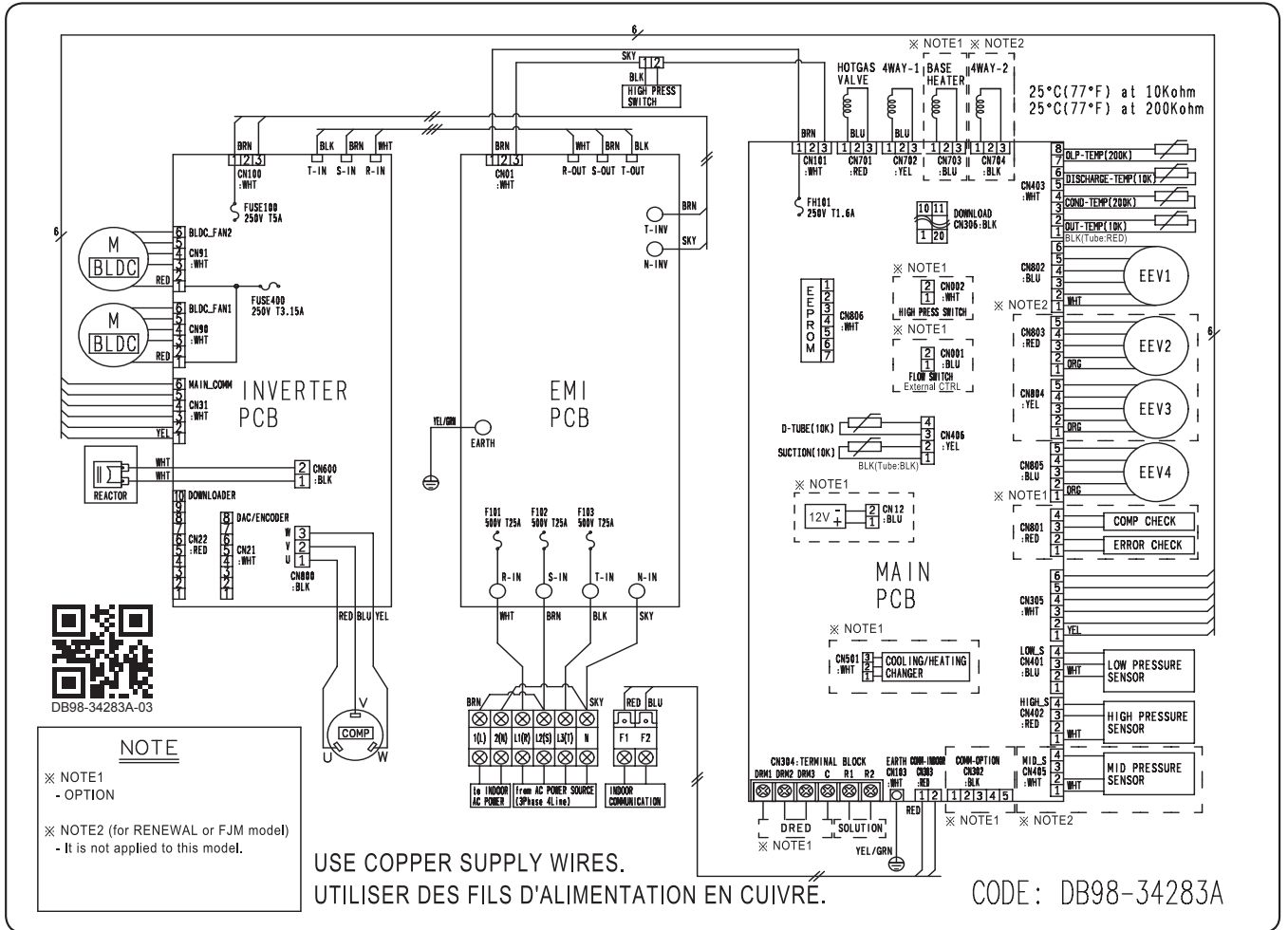

MAIN PCB	Printed circuit board (Main)	4WAY-1 VALVE	Solenoid valve (4WAY)	OLP-TEMP	Thermistor (Liquid)
INVERTER PCB	Printed circuit board (Inverter)	4WAY-2 VALVE	Solenoid valve (4WAY)	DISCHARGE-TEMP	Thermistor (Discharge)
EMI PCB	Printed circuit board (emi1)	EEV	Electronic expansion valve	COND-TEMP	Thermistor (Liquid)
COMP	Motor (Compressor)	HOTGAS VALVE	Solenoid valve (Hotgas-bypass)	LIQUID TEMP	Thermistor (Liquid)
BLDC	Motor (ODU Fan)	HOTGAS VALVE	Solenoid valve (Hotgas-bypass)	OUT-TEMP	Thermistor (Air)
REACTOR	DC_Reactor	500V T25A	FUSE		

NOTE

- This wiring diagram applies only to the outdoor unit.
- Colors blk: black, red: red, blu: blue, wht: white, yel: yellow, brn: brown, sky: skyblue, org: orange, grn: green
- When operating, don't shortcircuit the protection device (High Pressure switch)
- For connection wiring indoor-outdoor transmission F1-F2, outdoor-outdoor transmission OF1-OF2, refer to the installation manual.
- Protective earth(SCREW), : connector, : The wire quantity

6. Electrical Wiring Diagram

AM080FXMDGH/EU

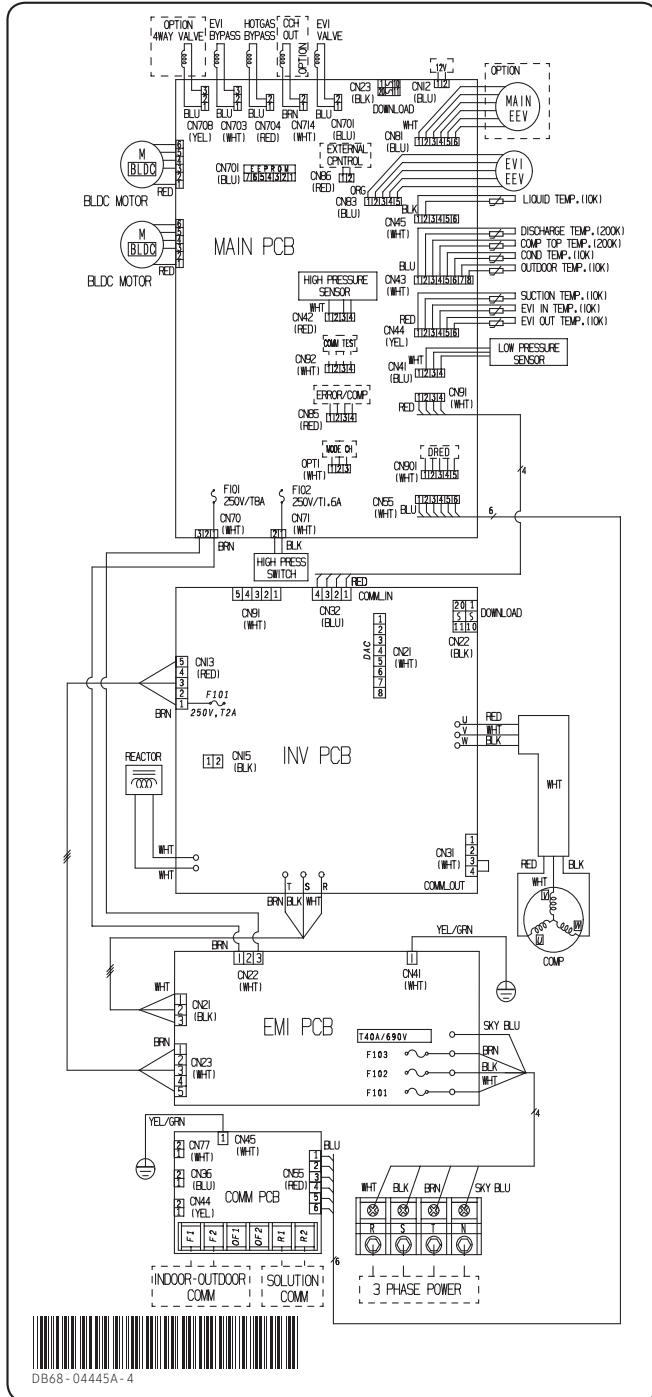

MAIN BOARD	Printed circuit board (Main)
INV PCB	Printed circuit board (Inverter)
EMI PCB	Printed circuit board (emi1)
COMM PCB	Printed circuit board (Communication)
COMP	Motor (Compressor)
BLDC MOTOR	Motor (ODU Fan)
REACTOR	DC_Reactor
4WAY VALVE	Solenoid valve (4WAY)
EVI BYPASS	Solenoid valve (EVI-bypass)
HOTGAS BYPASS	Solenoid valve (Hotgas-bypass)
CCH OUT	Crank Case Heater (Compressor)
EVI BYPASS	Solenoid valve (EVI-bypass)
HOTGAS BYPASS	Solenoid valve (Hotgas-bypass)
CCH OUT	Crank Case Heater (Compressor)
EVI VALVE	Solenoid valve (EVI)
MAIN EEV	Electronic expansion valve (Main cooling)
EVI EEV	Electronic expansion valve (EVI)
HOTGAS BYPASS	Solenoid valve (Hotgas-bypass)
CCH OUT	Crank Case Heater (Compressor)
EVI BYPASS	Solenoid valve (EVI-bypass)
HOTGAS BYPASS	Solenoid valve (Hotgas-bypass)
CCH OUT	Crank Case Heater (Compressor)
EVI VALVE	Solenoid valve (EVI)
MAIN EEV	Electronic expansion valve (Main cooling)
EVI EEV	Electronic expansion valve (EVI)

NOTE

- This wiring diagram applies only to the outdoor unit.
- Colors blk: black, red: red, blu: blue, wht: white, yel: yellow, brn: brown, sky: skyblue, org: orange, grn: green
- When operating, don't shortcircuit the protection device (High Pressure switch)
- For connection wiring indoor-outdoor transmission F1-F2, outdoor-outdoor transmission OF1-OF2, refer to the installation manual.
- Protective earth(SCREW), : connector, : The wire quantity

6. Electrical Wiring Diagram

AM080MXMDGH/EU

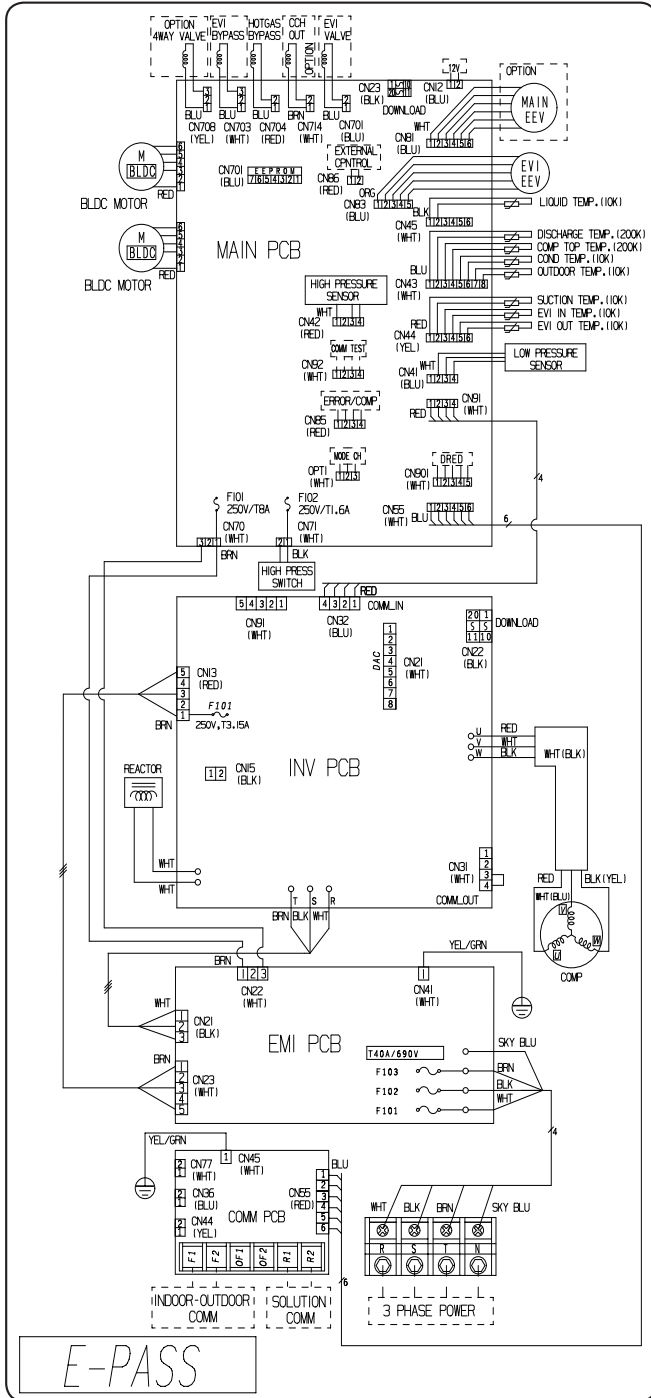

MAIN BOARD	Printed circuit board (Main)
INV PCB	Printed circuit board (Inverter)
EMI PCB	Printed circuit board (emi1)
COMM PCB	Printed circuit board (Communication)
COMP	Motor (Compressor)
BLDC MOTOR	Motor (ODU Fan)
REACTOR	DC_Reactor
4WAY VALVE	Solenoid valve (4WAY)
EVI BYPASS	Solenoid valve (EVI-bypass)
HOTGAS BYPASS	Solenoid valve (Hotgas-bypass)
CCH OUT	Crank Case Heater (Compressor)
EVI BYPASS	Solenoid valve (EVI-bypass)
HOTGAS BYPASS	Solenoid valve (Hotgas-bypass)
CCH OUT	Crank Case Heater (Compressor)
EVI VALVE	Solenoid valve (EVI)
MAIN EEV	Electronic expansion valve (Main cooling)
EVI EEV	Electronic expansion valve (EVI)
HOTGAS BYPASS	Solenoid valve (Hotgas-bypass)
CCH OUT	Crank Case Heater (Compressor)
EVI BYPASS	Solenoid valve (EVI-bypass)
HOTGAS BYPASS	Solenoid valve (Hotgas-bypass)
CCH OUT	Crank Case Heater (Compressor)
EVI VALVE	Solenoid valve (EVI)
MAIN EEV	Electronic expansion valve (Main cooling)
EVI EEV	Electronic expansion valve (EVI)

NOTE

- This wiring diagram applies only to the outdoor unit.
- Colors blk: black, red: red, blu: blue, wht: white, yel: yellow, brn: brown, sky: skyblue, org: orange, grn: green
- When operating, don't shortcircuit the protection device (High Pressure switch)
- For connection wiring indoor-outdoor transmission F1-F2, outdoor-outdoor transmission OF1-OF2, refer to the installation manual.
- Protective earth(SCREW), : connector, : The wire quantity

6. Electrical Wiring Diagram

AM100KXMDGH/EU, AM120KXMDGH/EU

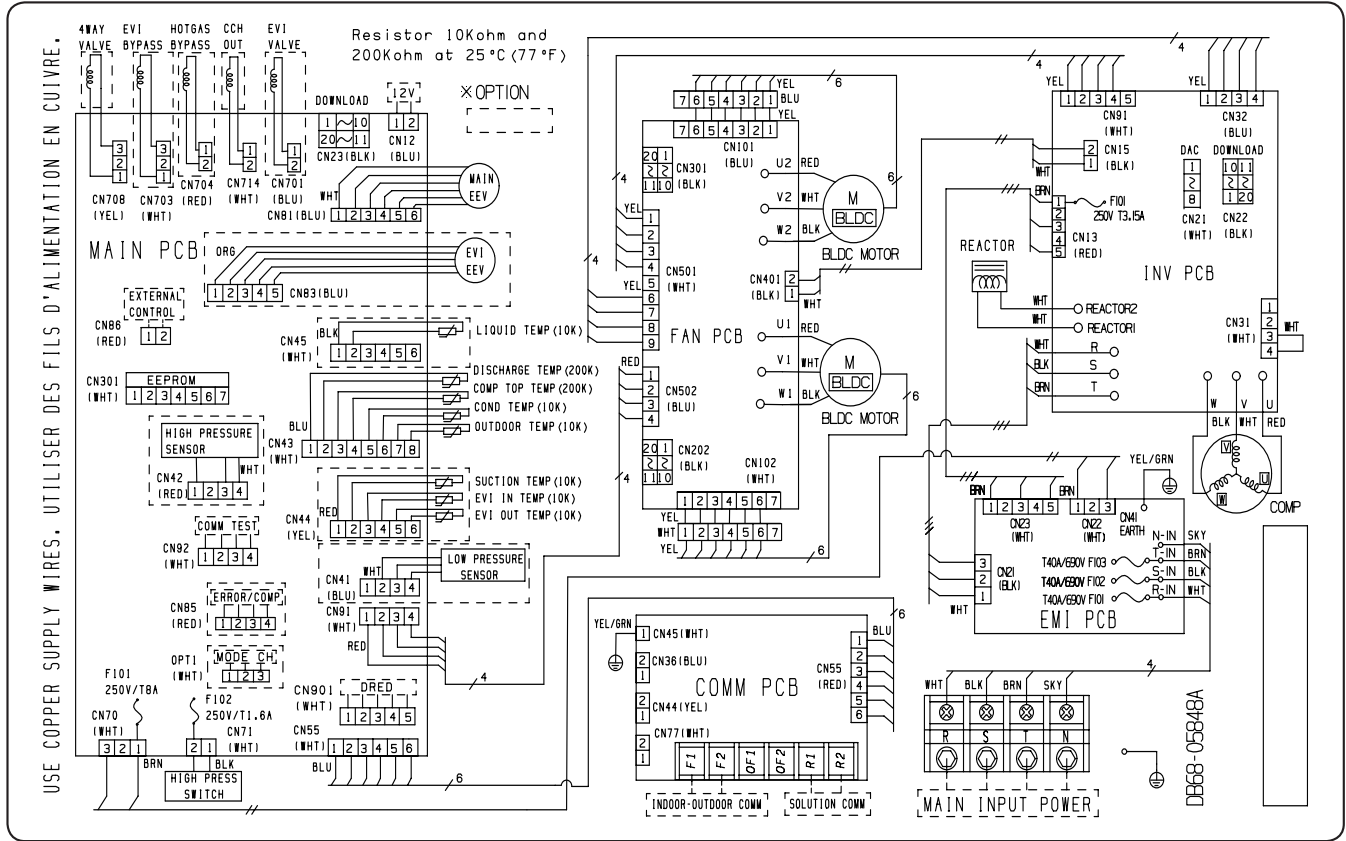

MAIN PCB	Printed circuit board (Main)	EVI BYPASS	Solenoid valve (EVI-bypass)	T40A / 690	FUSE
FAN PCB	Printed circuit board (Fan)	HOTGAS BYPASS	Solenoid valve (Hotgas-bypass)	LIQUID TEMP	Thermistor (Liquid)
INV PCB	Printed circuit board (Inverter)	CCH OUT	Crank Case Heater (Compressor)	DISCHARGE TEMP	Thermistor (Discharge)
EMI PCB	Printed circuit board (emi1)	EVI BYPASS	Solenoid valve (EVI-bypass)	COMP TOP TEMP	Thermistor (Compressor Top)
COMM PCB	Printed circuit board (Communication)	HOTGAS BYPASS	Solenoid valve (Hotgas-bypass)	OUTDOOR TEMP	Thermistor (Air)
COMP	Motor (Compressor)	CCH OUT	Crank Case Heater (Compressor)	SUCTION TEMP	Thermistor (Suction)
BLDC MOTOR	Motor (ODU Fan)	EVI VALVE	Solenoid valve (EVI)	EVI IN TEMP	Thermistor (EVI IN)
REACTOR	DC_Reactor	MAIN EEV	Electronic expansion valve (Main cooling)	EVI OUT TEMP	Thermistor (EVI OUT)
4WAY VALVE	Solenoid valve (4WAY)	EVI EEV	Electronic expansion valve (EVI)		

NOTE

- This wiring diagram applies only to the outdoor unit.
- Colors blk: black, red: red, blu: blue, wht: white, yel: yellow, brn: brown, sky: skyblue, org: orange, grn: green
- When operating, don't shortcircuit the protection device (High Pressure switch)
- For connection wiring indoor-outdoor transmission F1-F2, outdoor-outdoor transmission OF1-OF2, refer to the installation manual.
- Protective earth(SCREW), : connector, : The wire quantity

6. Electrical Wiring Diagram

AM140KXMDGH/EU

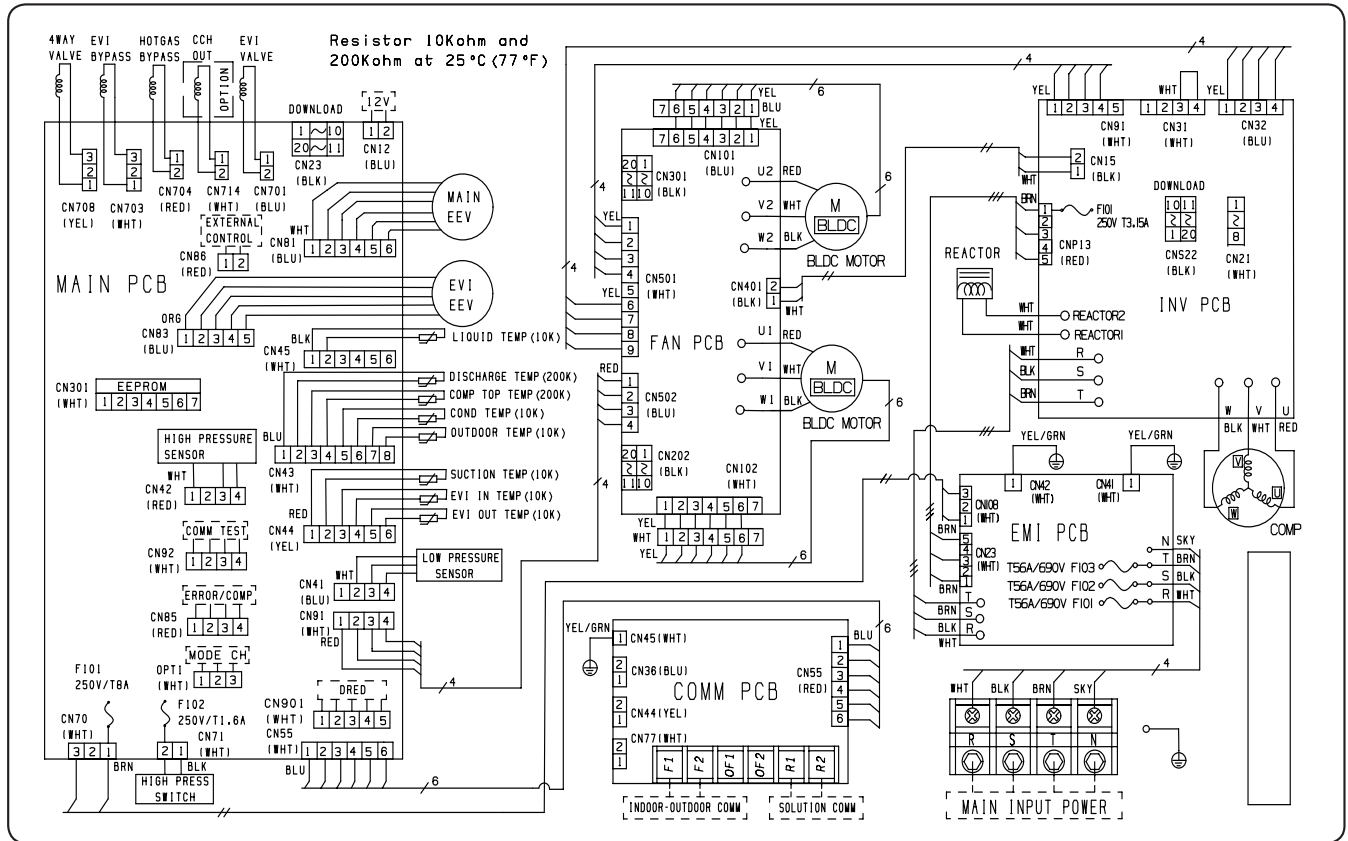

MAIN PCB	Printed circuit board (Main)	EVI BYPASS	Solenoid valve (EVI-bypass)	T56A / 690	FUSE
FAN PCB	Printed circuit board (Fan)	HOTGAS BYPASS	Solenoid valve (Hotgas-bypass)	LIQUID TEMP	Thermistor (Liquid)
INV PCB	Printed circuit board (Inverter)	CCH OUT	Crank Case Heater (Compressor)	DISCHARGE TEMP	Thermistor (Discharge)
EMI PCB	Printed circuit board (emi1)	EVI BYPASS	Solenoid valve (EVI-bypass)	COMP TOP TEMP	Thermistor (Compressor Top)
COMM PCB	Printed circuit board (Communication)	HOTGAS BYPASS	Solenoid valve (Hotgas-bypass)	OUTDOOR TEMP	Thermistor (Air)
COMP	Motor (Compressor)	CCH OUT	Crank Case Heater (Compressor)	SUCTION TEMP	Thermistor (Suction)
BLDC MOTOR	Motor (ODU Fan)	EVI VALVE	Solenoid valve (EVI)	EVI IN TEMP	Thermistor (EVI IN)
REACTOR	DC_Reactor	MAIN EEV	Electronic expansion valve (Main cooling)	EVI OUT TEMP	Thermistor (EVI OUT)
4WAY VALVE	Solenoid valve (4WAY)	EVI EEV	Electronic expansion valve (EVI)		

NOTE

- This wiring diagram applies only to the outdoor unit.
- Colors blk: black, red: red, blu: blue, wht: white, yel: yellow, brn: brown, sky: skyblue, org: orange, grn: green
- When operating, don't shortcircuit the protection device (High Pressure switch)
- For connection wiring indoor-outdoor transmission F1-F2, outdoor-outdoor transmission OF1-OF2, refer to the installation manual.
- Protective earth(SCREW), : connector, : The wire quantity

7. Sound Data

Summary

Capacity		Model	Sound Pressure dB(A)		Sound Power dB(A)
HP	KW		Cooling	Heating	
4	12.1	AM040KXMDEH/EU	52	54	73
5	14.0	AM050KXMDEH/EU	55	57	75
4	12.1	AM040FXMDEH/EU	50	52	66
4	12.1	AM040FXMDGH/EU	50	52	66
5	14.0	AM050FXMDEH/EU	51	53	67
5	14.0	AM050FXMDGH/EU	51	53	67
6	15.5	AM060FXMDEH/EU	53	55	69
6	15.5	AM060FXMDGH/EU	53	55	69
8	22.4	AM080FXMDGH/EU	56	58	74
8	22.4	AM080MXMDGH/EU	59	59	77
10	28.0	AM100KXMDGH/EU	58	60	74
12	33.4	AM120KXMDGH/EU	59	61	76
14	40.0	AM140KXMDGH/EU	62	64	79

NOTE

- Specifications may be subject to change without prior notice.
- Sound Pressure Level
 - Sound pressure level is obtained in an anechoic room.
 - Sound pressure level is a relative value, depending on the distance and acoustic environment.
 - Sound pressure level may differ depending on operation condition.
 - dBA = A-weighted sound pressure level
 - Reference acoustic pressure 0 dB = 20μPa
- Sound Power Level
 - Sound power level is an absolute value that a sound source generates.
 - dBA = A-weighted sound power level.
 - Reference power : 1pW.
 - Measured according to ISO 3741.

7. Sound Data

Sound Pressure level

Unit: dB(A)

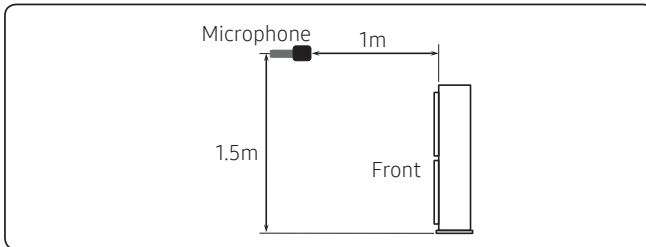

Model	Cooling	Silent1	Silent2	Silent3
AM040KXMDEH***	52	49	46	43
AM050KXMDEH***	55	52	49	46

- NR Curve

- 1) AM040KXMDEH***

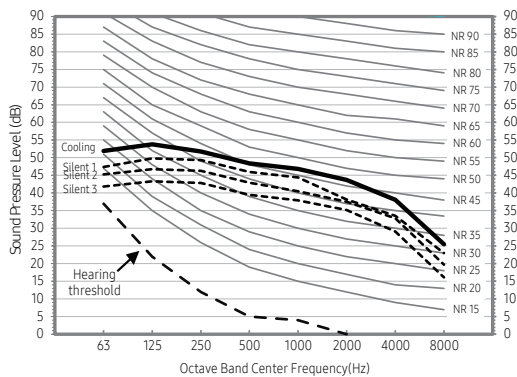

- 2) AM050KXMDEH***

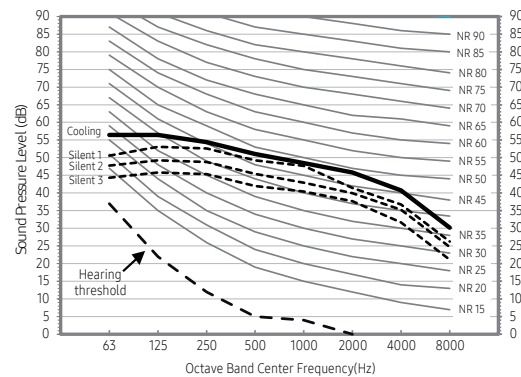

NOTE

- Specifications may be subject to change without prior notice.
- Sound pressure Level
 - Sound pressure level is obtained in an anechoic room.
 - Sound pressure level is a relative value, depending on the distance and acoustic environment.
 - Sound pressure level may differ depending on operation condition.
 - dBA = A weighted sound pressure level
 - Reference acoustic pressure 0 dB = 20μPa
- Silent mode available by option setting.
 - In cooling mode can be choose depending outdoor temperature/external contact signal
 - In heating mode can be choose only external contact signal

7. Sound Data

Unit: dB(A)

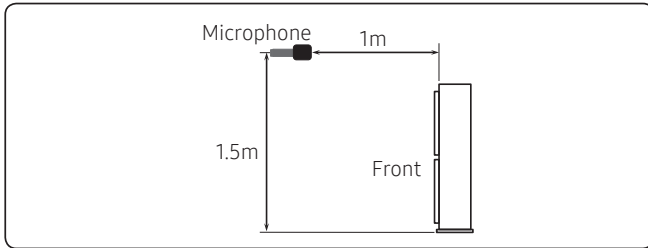

Model	Cooling	Silent1	Silent2	Silent3
AM040FXMD*****	50	47	44	41
AM050FXMD*****	51	48	45	42
AM060FXMD*****	53	50	47	44
AM080FXMD*****	56	53	50	47

• NR Curve

1) AM040FXMD*****

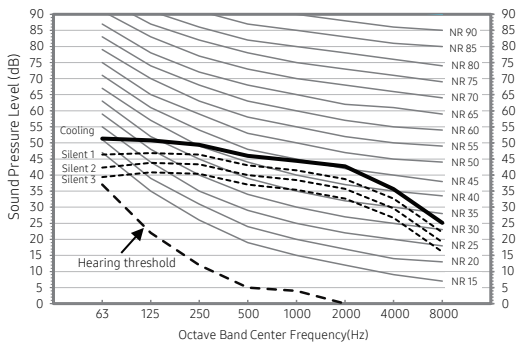

2) AM050FXMD*****

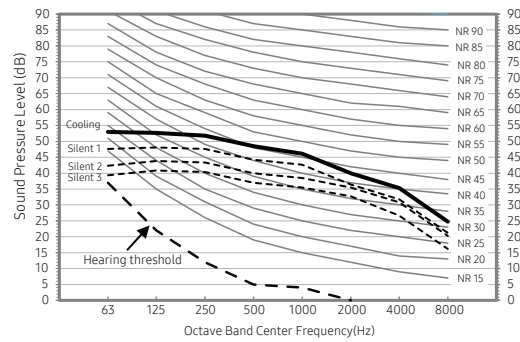

3) AM060FXMD*****

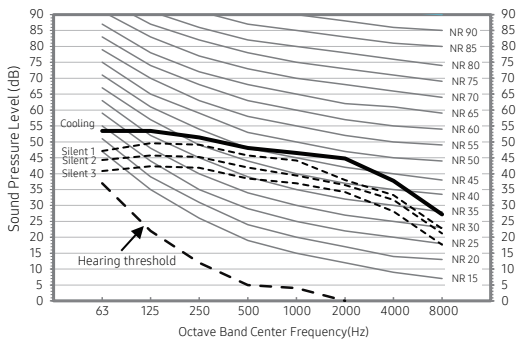

4) AM080FXMD*****

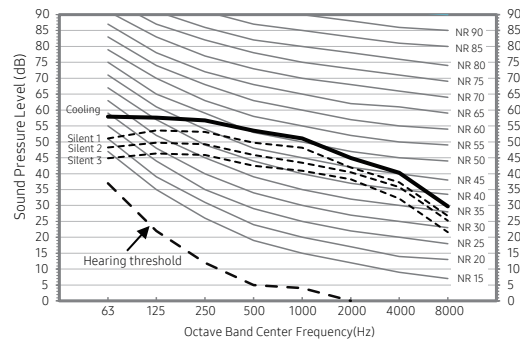

NOTE

- Specifications may be subject to change without prior notice.
- Sound pressure Level
 - Sound pressure level is obtained in an anechoic room.
 - Sound pressure level is a relative value, depending on the distance and acoustic environment.
 - Sound pressure level may differ depending on operation condition.
 - dBA = A weighted sound pressure level
 - Reference acoustic pressure 0 dB = 20μPa
- Silent mode available by option setting.
 - In cooling mode can be choose depending outdoor temperature/external contact signal
 - In heating mode can be choose only external contact signal

7. Sound Data

Unit: dB(A)

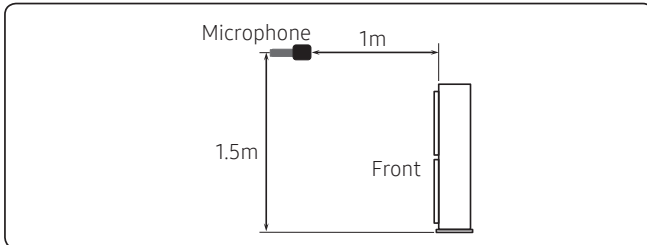

Model	Cooling	Silent1	Silent2	Silent3
AM080MXMD*****	59	56	53	50
AM100KXMD*****	58	55	52	49
AM120KXMD*****	59	56	53	50
AM140KXMD*****	62	59	56	53

• NR Curve

1) AM080MXMD*****

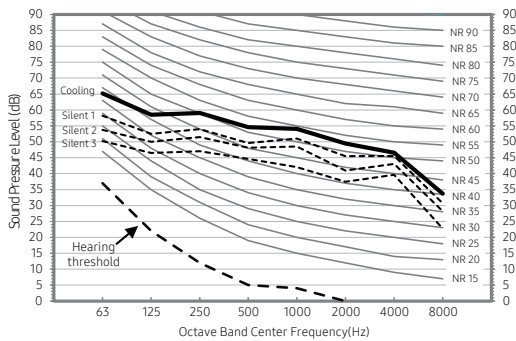

2) AM100KXMD*****

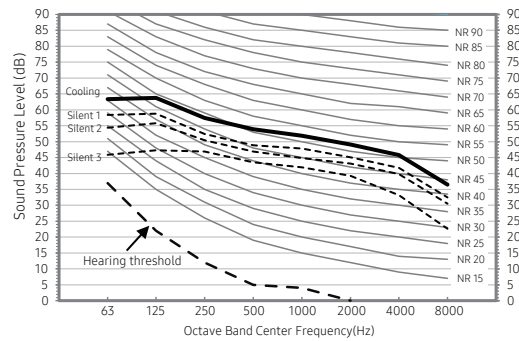

3) AM120KXMD*****

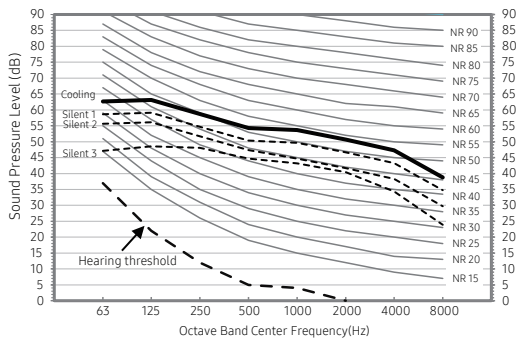

4) AM140KXMD*****

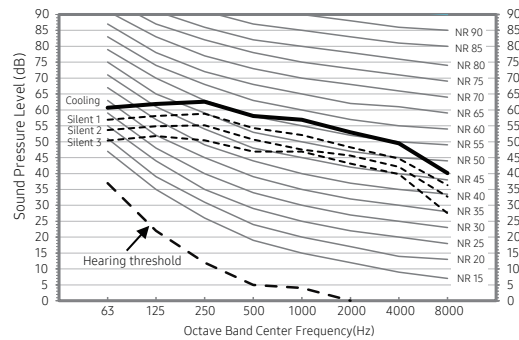

NOTE

- Specifications may be subject to change without prior notice.
- Sound pressure Levels
 - Sound pressure level is obtained in an anechoic room.
 - Sound pressure level is a relative value, depending on the distance and acoustic environment.
 - Sound pressure level may differ depending on operation condition.
 - dBA = A weighted sound pressure level
 - Reference acoustic pressure 0 dB = 20μPa
- Silent mode available by option setting.
 - In cooling mode can be choose depending outdoor temperature/external contact signal
 - In heating mode can be choose only external contact signal

7. Sound Data

Sound Power level

Unit: dB(A)

Model	Power
AM040KXMDEH***	73
AM050KXMDEH***	75

1) AM040KXMDEH***

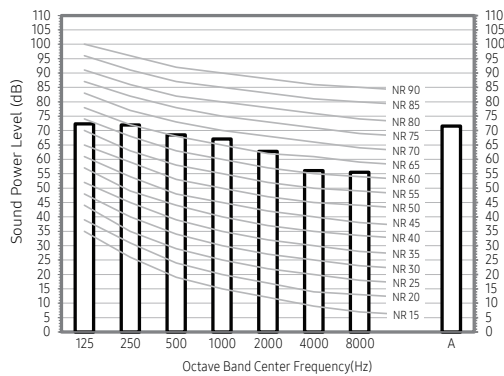

2) AM050KXMDEH***

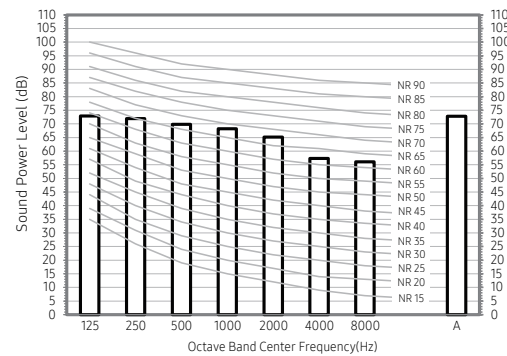

NOTE

- Specifications may be subject to change without prior notice
- Sound Power Level
 - Sound power level is an absolute value that a sound source generates.
 - dBA = A-weighted sound power level.
 - Reference power : 1pW.
 - Measured according to ISO 3741.

7. Sound Data

Unit: dB(A)

Model	Power
AM040FXMD*****	66
AM050FXMD*****	67
AM060FXMD*****	69
AM080FXMD*****	74

1) AM040FXMD*****

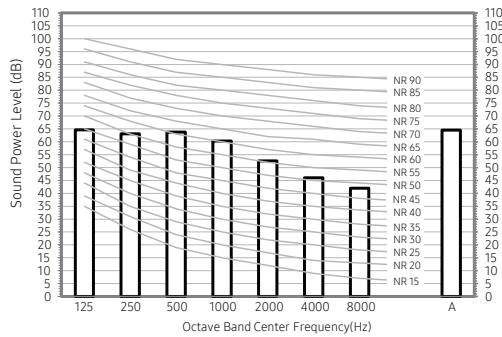

2) AM050FXMD*****

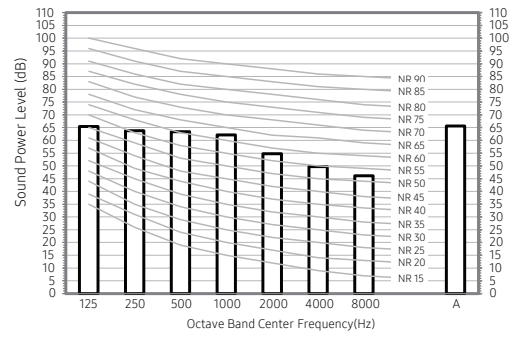

3) AM060FXMD*****

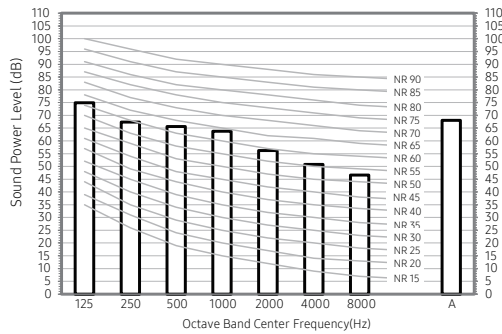

4) AM080FXMD*****

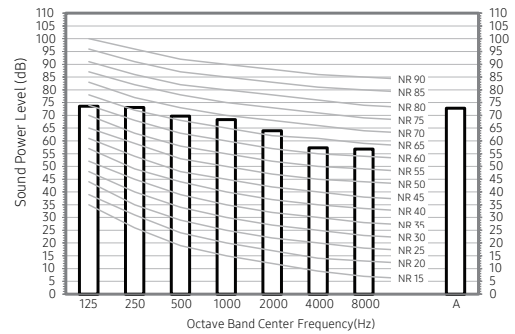

NOTE

- Specifications may be subject to change without prior notice
- Sound Power Level
 - Sound power level is an absolute value that a sound source generates.
 - dBA = A-weighted sound power level.
 - Reference power : 1pW.
 - Measured according to ISO 3741.

7. Sound Data

Unit: dB(A)

Model	Power
AM080MXMD*****	77
AM100KXMD*****	74
AM120KXMD*****	76
AM140KXMD*****	79

1) AM080MXMD*****

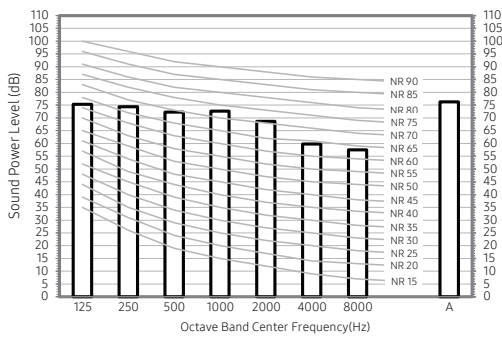

2) AM100KXMD*****

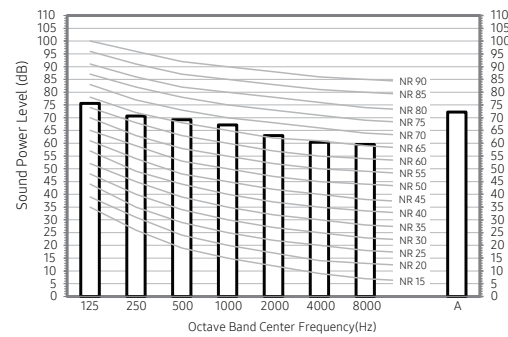

3) AM120KXMD*****

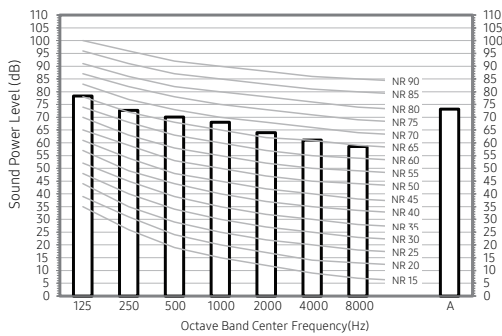

4) AM140KXMD*****

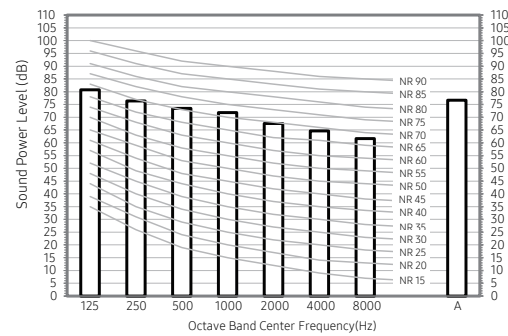

NOTE

- Specifications may be subject to change without prior notice
- Sound Power Level
 - Sound power level is an absolute value that a sound source generates.
 - dBA = A-weighted sound power level.
 - Reference power : 1pW.
 - Measured according to ISO 3741.

8. Operation Range

AM040KXMDEH/EU, AM050KXMDEH/EU, AM080✕XMDGH/EU

Cooling

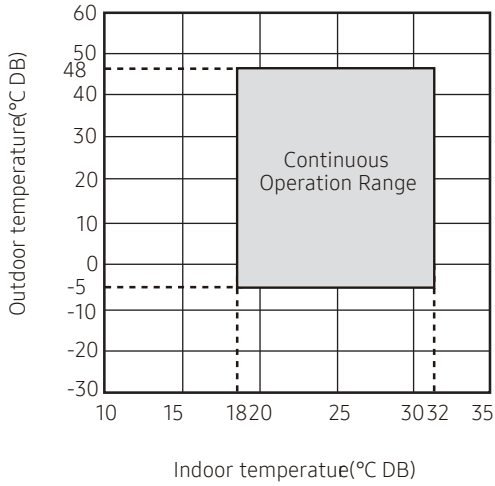

Heating

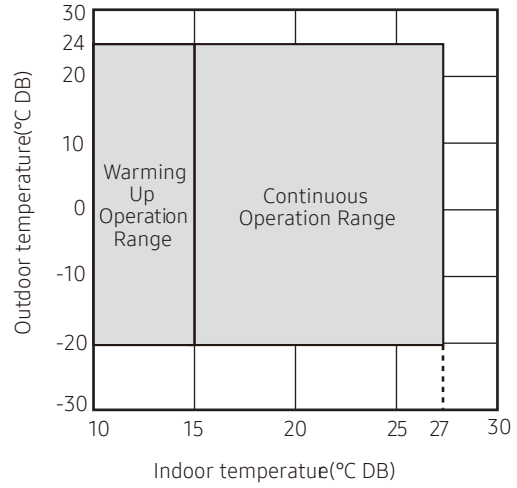

AM040FXMD✕H/EU, AM050FXMD✕H/EU, AM060FXMD✕H/EU

Cooling

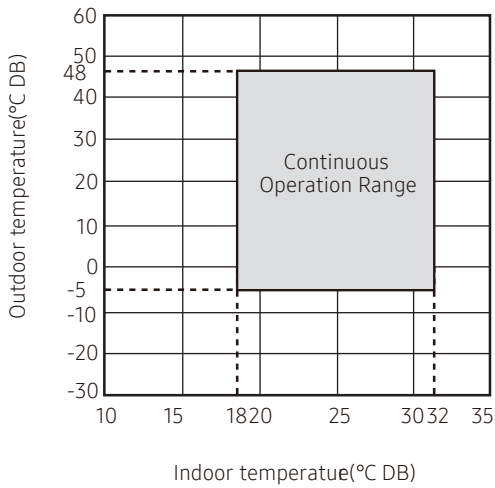

Heating

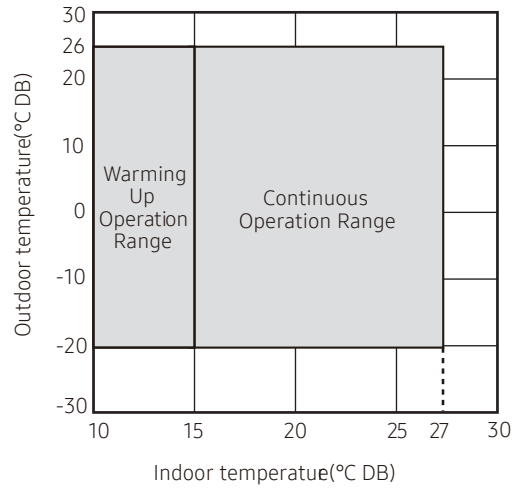

8. Operation Range

AM100KXMDGH/EU, AM120KXMDGH/EU, AM140KXMDGH/EU

Cooling

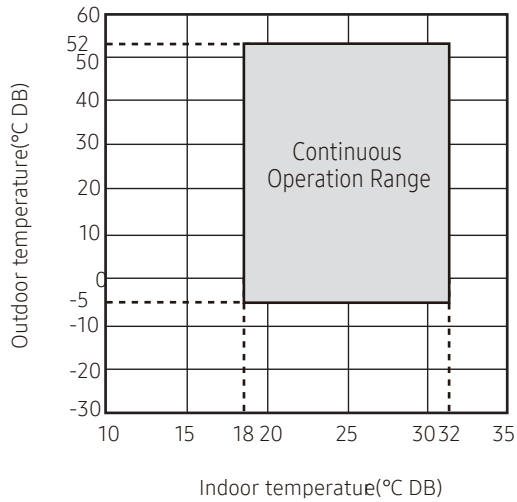

Heating

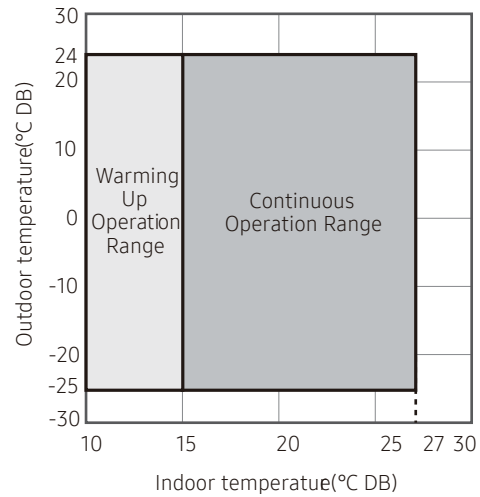

NOTE

- The standardized temperature for heating is 7°C DB. If the outdoor temperature drops to 0°C DB or below, the heating capacity can be reduced depending on the temperature condition.
- The use of the air conditioner at a relative humidity above the expected one (80%) may cause the formation of condensate and the leakage of water drops on the floor.

8. Operation Range

Defrosting correction factor

The heating capacity tables do not take account of the reduction in capacity, when frost has accumulated or while the defrosting operation is in progress. The capacity values, which take these factors into account, in other words, the integrated heating capacity values, can be calculated as follows :

- (1) Formula : $A = B \times C$
- (2) Integrated heating capacity = A
- (3) Value given in table of capacity characteristics = B
- (4) Integrating correction factor for frost accumulation (kW) = C

Outdoor temperature (°C, DB) / WB	-10 / -10.4	-8 / -8.5	-6 / -6.5	-4 / -4.6	-2 / -2.7	0 / -0.7	2 / 1.2	5 / 4.1	7 / 6
Capacity coefficient	0.99	0.98	0.96	0.95	0.91	0.88	0.86	0.91	1.00

Capacity coefficient of outdoor unit on defrost operation

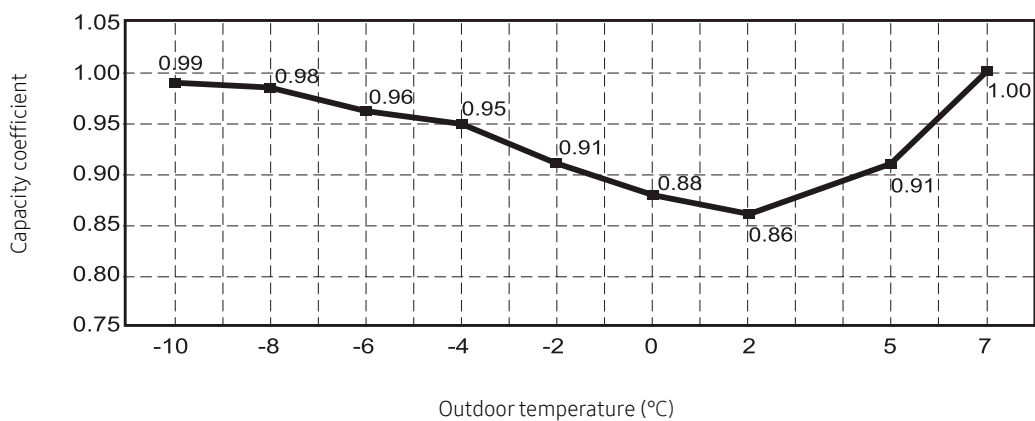

On heating operation, frost can be formed on heat exchanger according to outdoor temperature.
(Frost on heat exchanger results in decreasing the performance.)

To remove frost on heat exchanger of outdoor unit, defrost operation is carried out periodically.

During defrost operation, capacity of outdoor unit may decrease.

The decrement is not considered to the individual capacity tables.

This figure shows an effect of intelligence defrost operation

It is actually the frost occurrence section from 0 °C or less.

Since the outdoor temperature over 0 °C, the heating performance is the same before and after applying intelligence defrost operation

In outdoor conditions below 0 °C, frost conditions reflect the actual entering the defrost operation because heating performance is improved

9. Piping Diagram

AM040KXMDEH/EU, AM050KXMDEH/EU

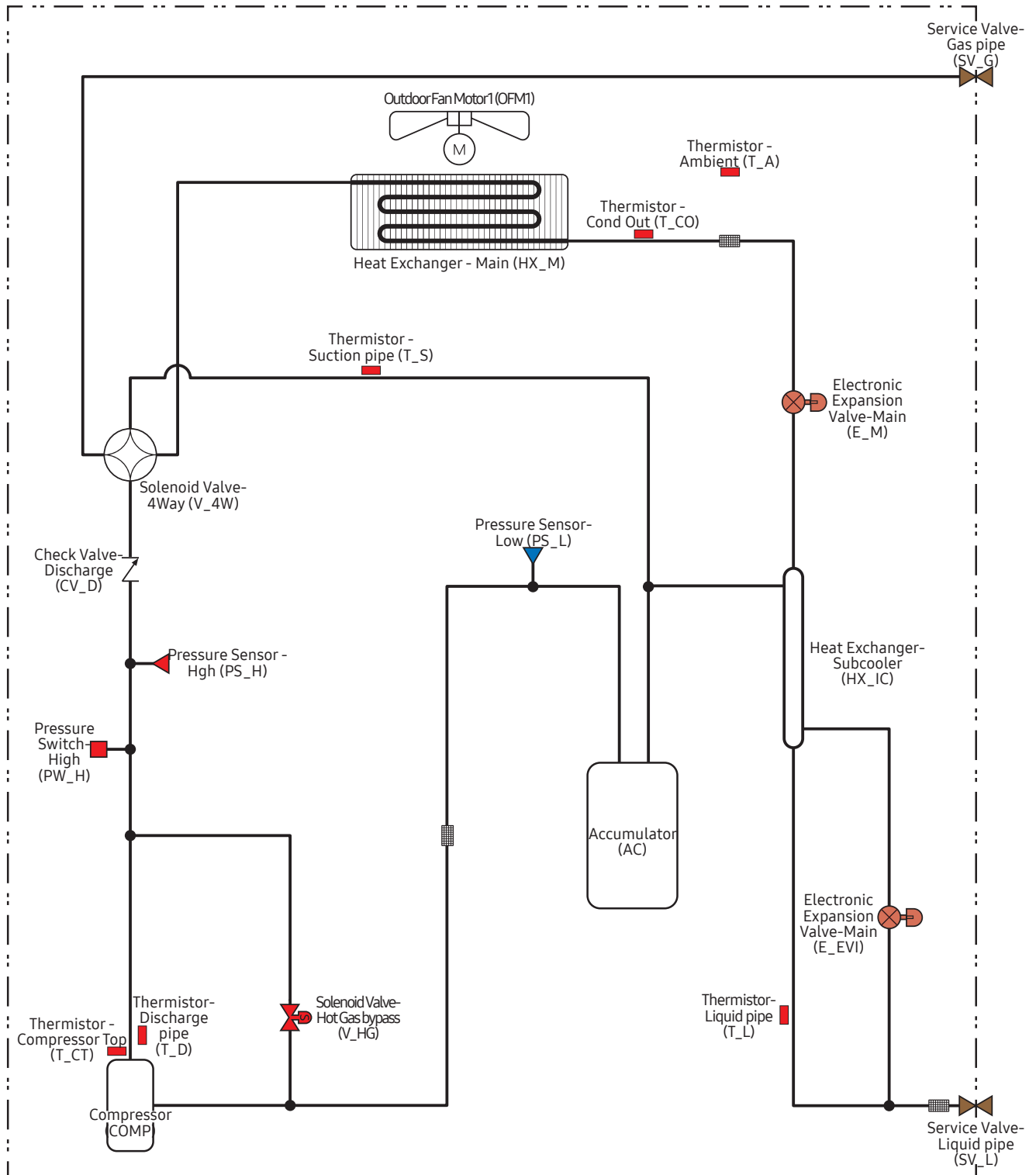

9. Piping Diagram

AM040FXMDEH/EU, AM040FXMDGH/EU, AM050FXMDEH/EU, AM050FXMDGH/EU,
AM060FXMDEH/EU, AM060FXMDGH/EU

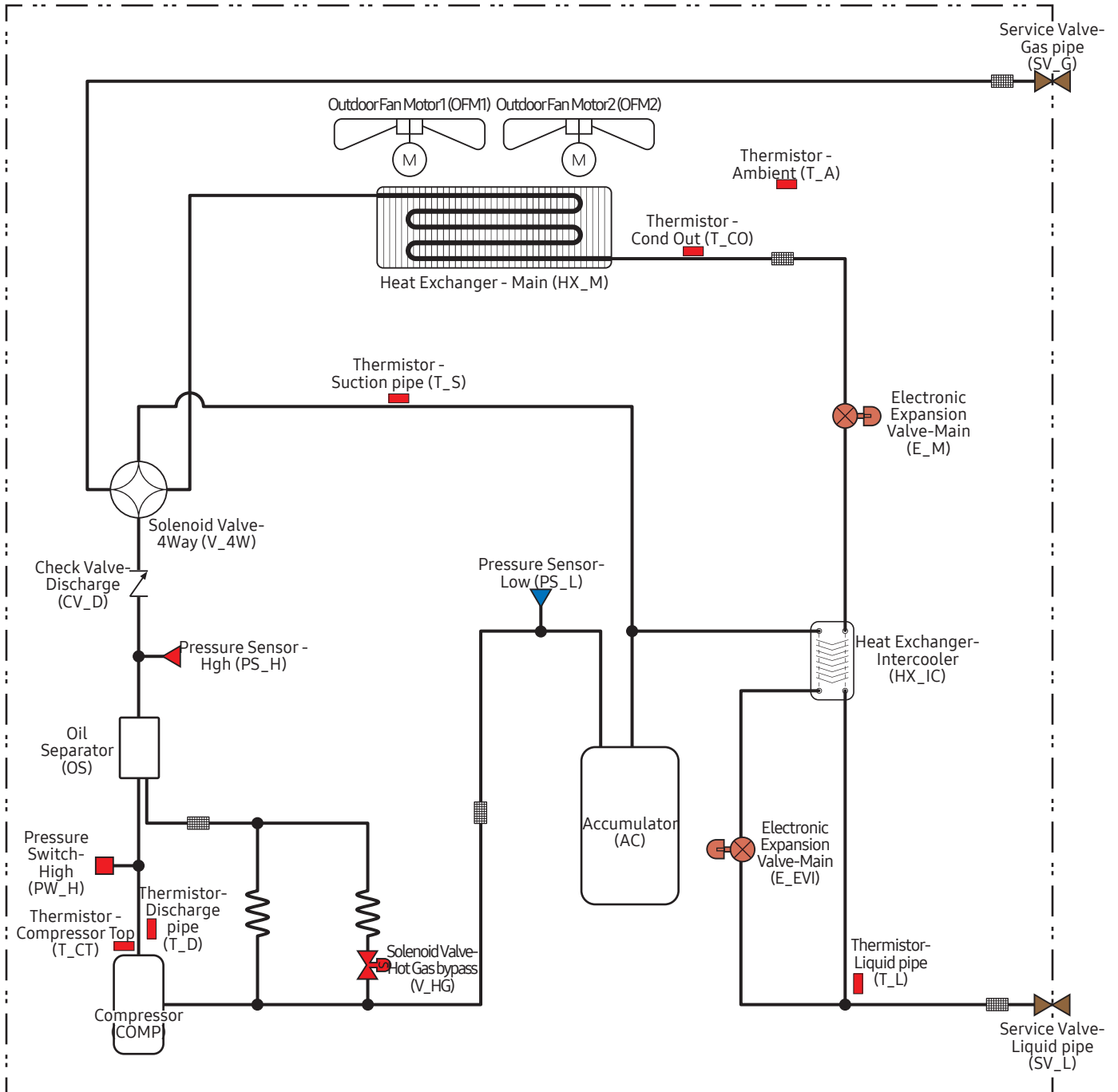

9. Piping Diagram

AM080FXMDGH/EU

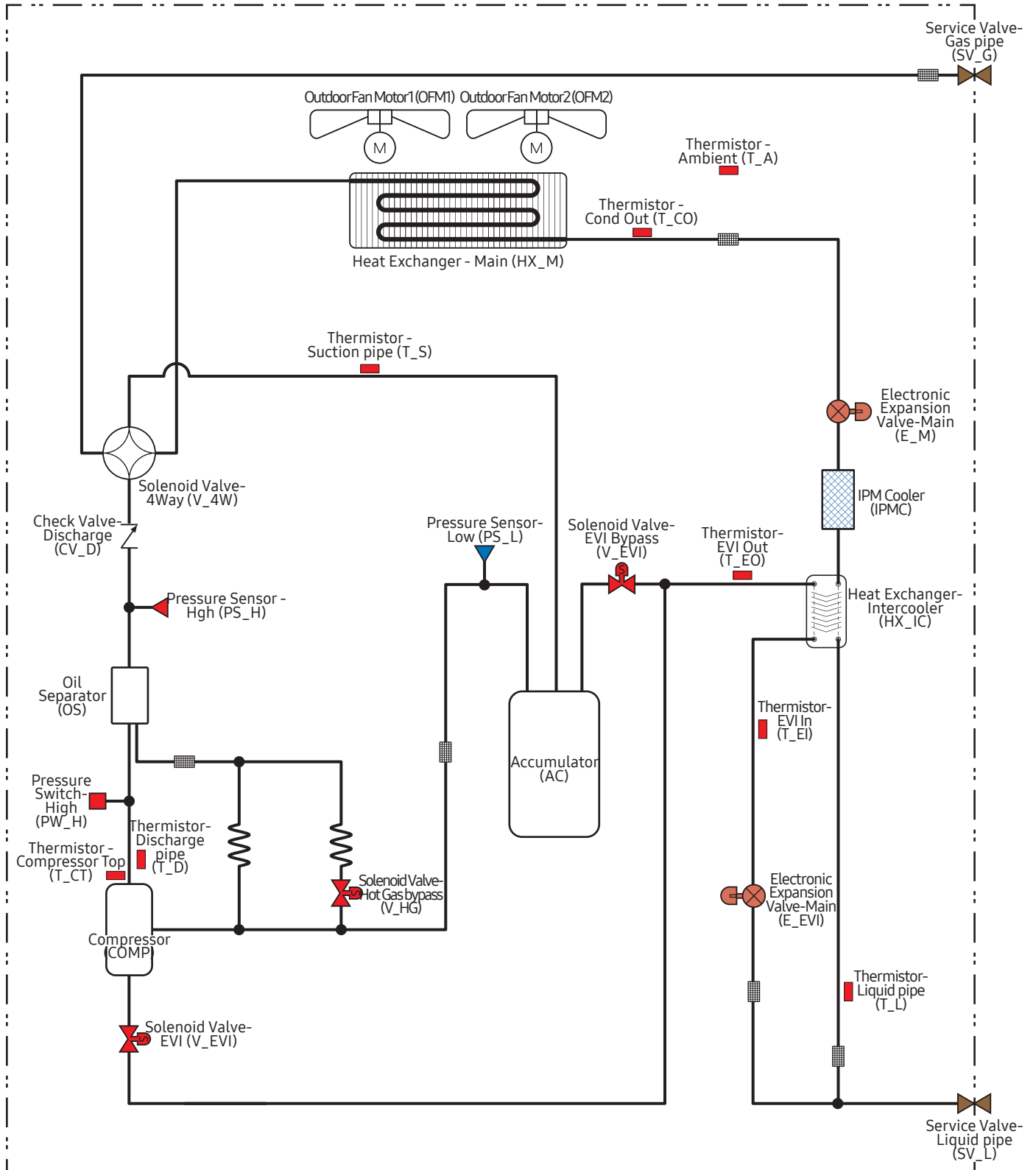

9. Piping Diagram

AM080MXMDGH/EU

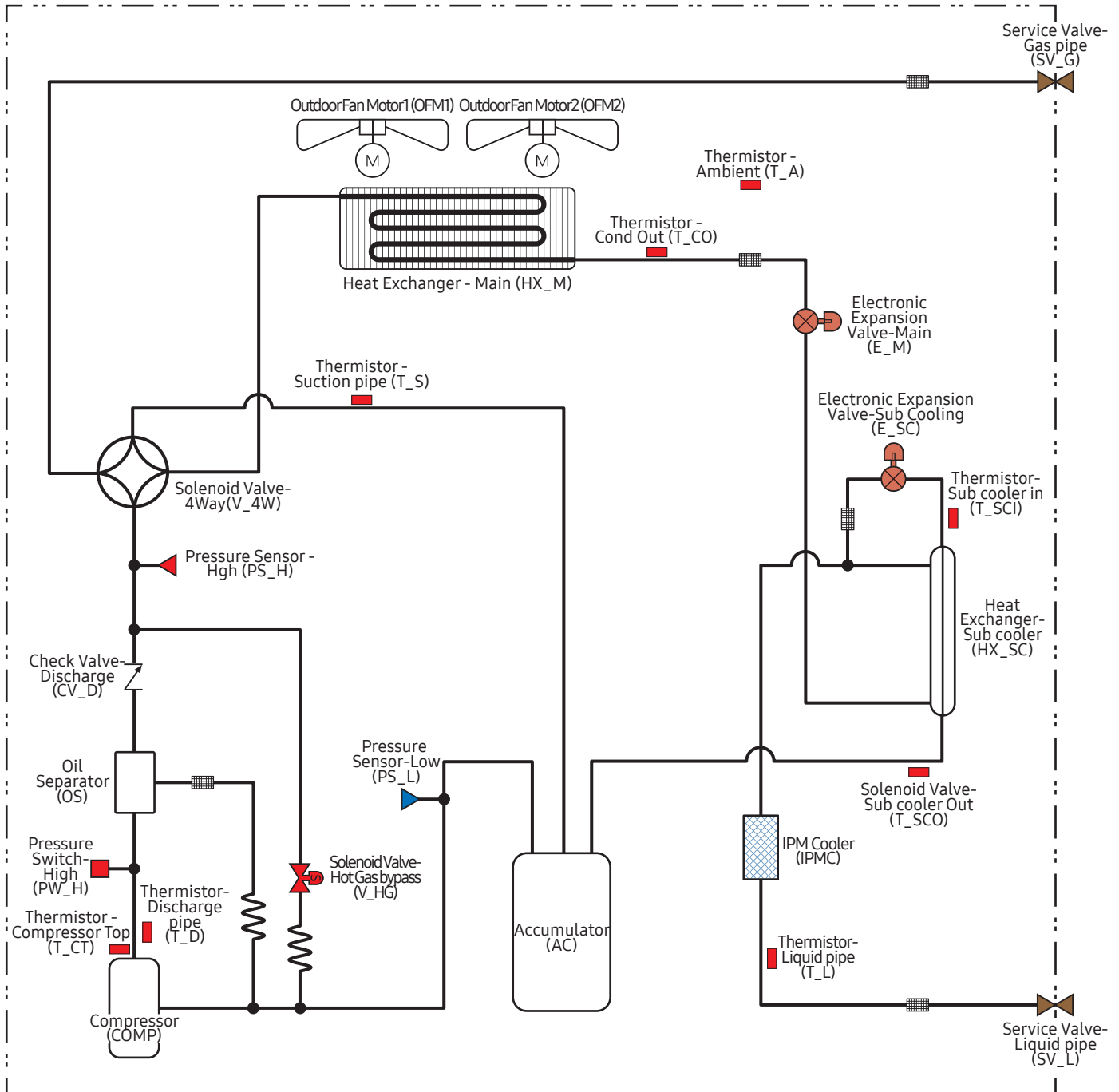

9. Piping Diagram

AM100KXMDGH/EU, AM120KXMDGH/EU, AM140KXMDGH/EU

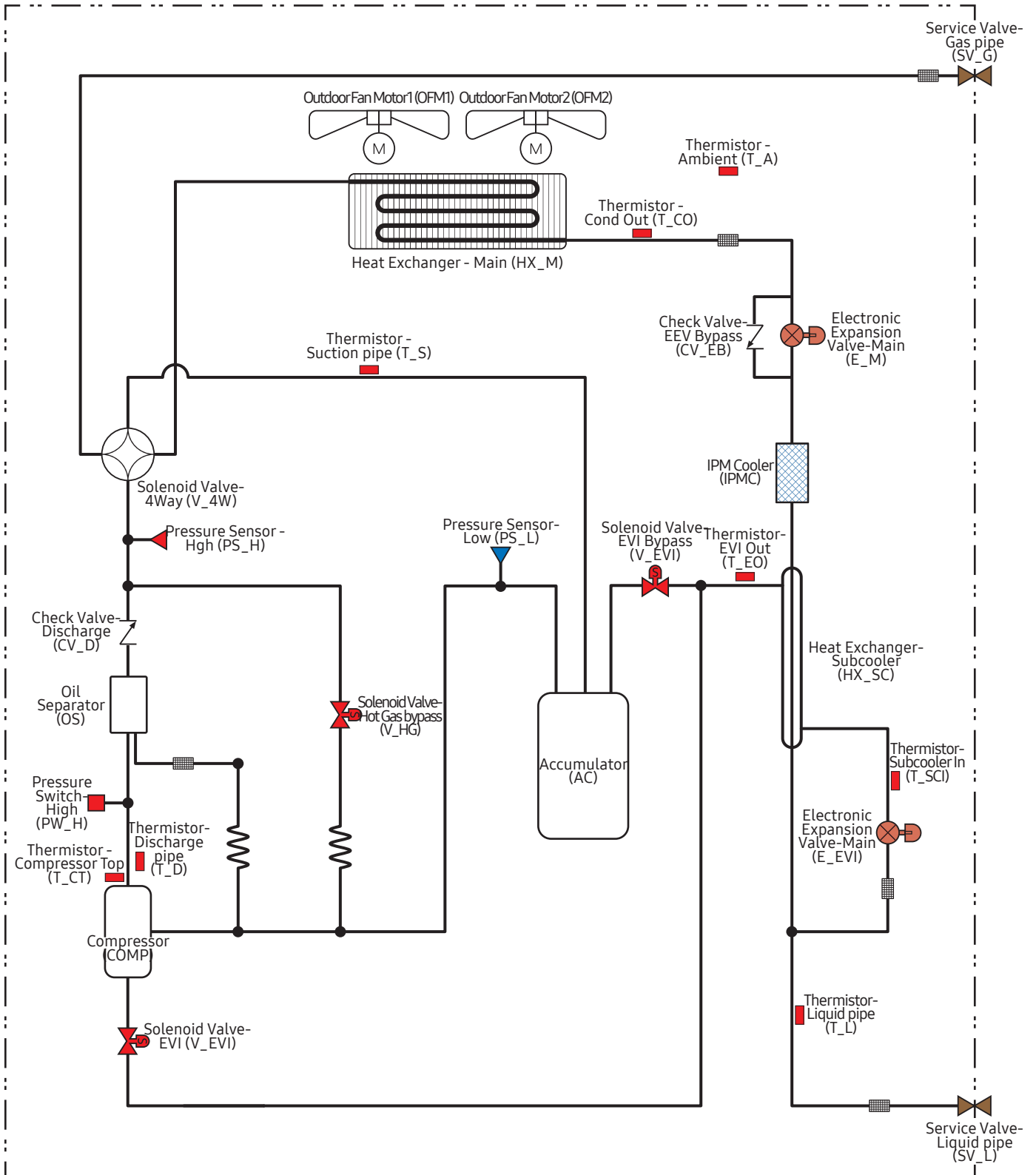

10. Capacity Table

AM040KXMDEH/EU

Cooling

TC : Total Capacity, PI : Power Input

Combination, % (Capacity index)	Outdoor temperature (°C, DB)	Indoor temperature (°C, WB)														
		14		16		18		19		20		22		24		
		TC kW	PI	TC kW	PI	TC kW	PI	TC kW	PI	TC kW	PI	TC kW	PI	TC kW	PI	
130	10	10.80	1.47	12.80	1.81	14.90	2.15	16.00	2.32	16.80	2.44	17.20	2.32	17.50	2.20	
	12	10.80	1.49	12.80	1.83	14.90	2.20	15.90	2.37	16.60	2.43	16.90	2.30	17.40	2.25	
	14	10.80	1.53	12.80	1.88	14.90	2.24	15.90	2.42	16.30	2.41	16.70	2.39	17.10	2.40	
	16	10.80	1.57	12.80	1.92	14.90	2.29	15.90	2.51	16.10	2.52	16.40	2.54	16.90	2.55	
	18	10.80	1.59	12.80	1.96	14.90	2.47	15.60	2.66	15.80	2.67	16.20	2.68	16.60	2.70	
	20	10.70	1.63	12.70	2.12	14.80	2.68	15.50	2.82	15.60	2.83	16.00	2.83	16.40	2.87	
	21	10.70	1.68	12.70	2.19	14.80	2.80	15.30	2.90	15.50	2.91	15.90	2.93	16.30	2.94	
	23	10.70	1.81	12.70	2.38	14.80	3.03	15.10	3.06	15.20	3.07	15.70	3.08	16.00	3.11	
	25	10.70	1.97	12.70	2.58	14.60	3.22	14.90	3.22	15.10	3.24	15.40	3.25	15.80	3.28	
	27	10.70	2.13	12.70	2.79	14.40	3.39	14.60	3.38	14.80	3.40	15.20	3.43	15.60	3.44	
	29	10.70	2.30	12.70	3.01	14.20	3.55	14.40	3.57	14.60	3.59	14.90	3.61	15.40	3.62	
	31	10.70	2.46	12.70	3.28	14.00	3.74	14.10	3.76	14.30	3.76	14.80	3.78	15.10	3.82	
	33	10.70	2.67	12.70	3.54	13.70	3.94	14.00	3.95	14.10	3.95	14.50	3.97	14.90	3.99	
	35	10.60	2.89	12.60	3.84	13.50	4.14	13.70	4.14	13.80	4.16	14.30	4.17	14.60	4.21	
	37	10.30	3.14	12.20	4.20	12.80	4.37	13.10	4.38	13.20	4.40	13.60	4.43	14.00	4.44	
	39	10.10	3.42	12.00	4.59	12.40	4.62	12.60	4.61	12.70	4.65	13.10	4.66	13.50	4.68	
	120	10	9.90	1.35	11.80	1.64	13.80	1.95	14.70	2.11	15.70	2.27	16.90	2.40	17.30	2.30
		12	9.90	1.37	11.80	1.68	13.80	1.99	14.70	2.15	15.70	2.32	16.70	2.39	17.00	2.28
14		9.90	1.40	11.80	1.71	13.70	2.04	14.70	2.20	15.70	2.37	16.50	2.38	16.80	2.39	
16		9.90	1.42	11.80	1.74	13.70	2.08	14.70	2.27	15.70	2.45	16.20	2.53	16.50	2.54	
18		9.90	1.46	11.80	1.79	13.70	2.17	14.70	2.41	15.60	2.66	16.00	2.67	16.30	2.69	
20		9.90	1.48	11.80	1.87	13.70	2.35	14.70	2.63	15.40	2.81	15.70	2.84	16.10	2.84	
21		9.90	1.51	11.80	1.94	13.70	2.46	14.60	2.74	15.30	2.90	15.60	2.91	16.00	2.92	
23		9.80	1.63	11.80	2.10	13.70	2.66	14.60	2.97	15.00	3.06	15.40	3.08	15.80	3.09	
25		9.80	1.74	11.70	2.28	13.70	2.89	14.60	3.22	14.80	3.22	15.10	3.24	15.50	3.26	
27		9.80	1.89	11.70	2.47	13.60	3.12	14.30	3.40	14.50	3.39	15.00	3.41	15.30	3.42	
29		9.80	2.04	11.70	2.68	13.60	3.37	14.20	3.55	14.30	3.57	14.70	3.58	15.00	3.62	
31		9.80	2.19	11.70	2.88	13.60	3.67	13.90	3.74	14.10	3.74	14.50	3.77	14.80	3.79	
33		9.80	2.36	11.70	3.11	13.50	3.92	13.70	3.92	13.90	3.94	14.20	3.96	14.60	3.98	
35		9.80	2.55	11.70	3.37	13.20	4.11	13.40	4.13	13.70	4.14	14.00	4.16	14.30	4.19	
37		9.50	2.78	11.30	3.68	12.70	4.35	12.80	4.37	13.00	4.37	13.30	4.41	13.70	4.42	
39		9.30	3.02	11.10	4.01	12.20	4.61	12.40	4.62	12.60	4.61	12.90	4.65	13.20	4.66	
110		10	9.10	1.21	10.90	1.49	12.60	1.78	13.50	1.91	14.40	2.06	16.10	2.35	16.90	2.39
		12	9.10	1.25	10.90	1.52	12.60	1.80	13.50	1.95	14.40	2.11	16.10	2.40	16.70	2.38
	14	9.10	1.26	10.90	1.54	12.60	1.84	13.50	2.00	14.40	2.16	16.10	2.45	16.50	2.38	
	16	9.10	1.28	10.80	1.58	12.60	1.89	13.50	2.04	14.30	2.20	15.90	2.51	16.30	2.54	
	18	9.10	1.32	10.80	1.62	12.60	1.93	13.50	2.10	14.30	2.33	15.70	2.66	16.00	2.69	
	20	9.10	1.35	10.80	1.66	12.60	2.05	13.40	2.28	14.30	2.52	15.50	2.82	15.80	2.84	
	21	9.10	1.37	10.80	1.71	12.60	2.13	13.40	2.37	14.30	2.64	15.30	2.90	15.70	2.91	
	23	9.10	1.44	10.80	1.85	12.50	2.32	13.40	2.57	14.30	2.85	15.10	3.06	15.40	3.08	
	25	9.00	1.55	10.80	2.01	12.50	2.51	13.40	2.79	14.30	3.09	14.90	3.22	15.20	3.25	
	27	9.00	1.67	10.80	2.16	12.50	2.71	13.40	3.03	14.30	3.34	14.60	3.40	15.00	3.41	
	29	9.00	1.81	10.80	2.32	12.50	2.95	13.40	3.28	14.10	3.55	14.40	3.58	14.80	3.58	
	31	9.00	1.93	10.80	2.50	12.50	3.17	13.40	3.55	13.90	3.73	14.10	3.76	14.50	3.78	
	33	9.00	2.07	10.80	2.72	12.50	3.44	13.40	3.85	13.60	3.91	14.00	3.95	14.30	3.96	
	35	9.00	2.24	10.70	2.93	12.40	3.73	13.20	4.11	13.40	4.13	13.70	4.14	14.00	4.18	
	37	8.70	2.42	10.40	3.18	12.10	4.08	12.60	4.36	12.70	4.37	13.10	4.38	13.40	4.40	
	39	8.50	2.64	10.20	3.47	11.80	4.46	12.20	4.59	12.30	4.61	12.60	4.63	12.90	4.65	
	100	10	8.30	1.10	9.90	1.32	11.50	1.57	12.30	1.71	13.10	1.84	14.60	2.10	16.30	2.38
		12	8.30	1.12	9.90	1.37	11.50	1.62	12.30	1.74	13.10	1.88	14.60	2.15	16.30	2.43
14		8.30	1.14	9.90	1.38	11.50	1.64	12.30	1.78	13.00	1.92	14.60	2.20	16.20	2.47	
16		8.30	1.16	9.90	1.42	11.50	1.68	12.20	1.83	13.00	1.96	14.60	2.24	15.90	2.51	
18		8.30	1.19	9.90	1.45	11.40	1.72	12.20	1.87	13.00	2.01	14.60	2.38	15.70	2.66	
20		8.20	1.21	9.90	1.48	11.40	1.78	12.20	1.97	13.00	2.17	14.60	2.60	15.50	2.82	
21		8.20	1.22	9.90	1.50	11.40	1.85	12.20	2.05	13.00	2.25	14.60	2.71	15.30	2.90	
23		8.20	1.26	9.80	1.60	11.40	2.00	12.20	2.21	13.00	2.45	14.50	2.94	15.20	3.06	
25		8.20	1.35	9.80	1.74	11.40	2.16	12.20	2.41	13.00	2.65	14.50	3.19	14.90	3.23	
27		8.20	1.46	9.80	1.88	11.40	2.34	12.20	2.60	13.00	2.87	14.30	3.40	14.70	3.39	
29		8.20	1.58	9.80	2.03	11.40	2.53	12.20	2.81	12.90	3.11	14.20	3.55	14.40	3.58	
31		8.20	1.70	9.80	2.18	11.40	2.75	12.20	3.04	12.90	3.37	13.90	3.74	14.20	3.75	
33		8.20	1.82	9.80	2.35	11.40	2.95	12.10	3.30	12.90	3.65	13.70	3.92	14.00	3.95	
35		8.20	1.95	9.80	2.52	11.30	3.20	12.10	3.60	12.90	3.96	13.40	4.13	13.70	4.14	
37		7.90	2.13	9.50	2.74	11.00	3.48	11.70	3.89	12.50	4.32	12.80	4.37	13.10	4.39	
39		7.80	2.29	9.30	2.99	10.80	3.79	11.50	4.26	12.10	4.58	12.30	4.63	12.60	4.63	

10. Capacity Table

Combination, % (Capacity index)	Outdoor temperature (°C, DB)	Indoor temperature (°C, WB)													
		14		16		18		19		20		22		24	
		TC	PI	TC	PI	TC	PI	TC	PI	TC	PI	TC	PI	TC	PI
90	10	7.50	0.99	8.90	1.19	10.40	1.40	11.10	1.51	11.80	1.63	13.20	1.85	14.60	2.10
	12	7.50	1.00	8.90	1.20	10.30	1.43	11.00	1.54	11.70	1.67	13.20	1.90	14.60	2.15
	14	7.40	1.01	8.80	1.24	10.30	1.46	11.00	1.58	11.70	1.70	13.20	1.95	14.60	2.20
	16	7.40	1.04	8.80	1.26	10.30	1.49	11.00	1.61	11.70	1.74	13.20	1.99	14.60	2.24
	18	7.40	1.06	8.80	1.29	10.30	1.53	11.00	1.64	11.70	1.78	13.20	2.03	14.60	2.38
	20	7.40	1.09	8.80	1.31	10.30	1.55	11.00	1.69	11.70	1.85	13.20	2.20	14.60	2.59
	21	7.40	1.09	8.80	1.33	10.30	1.59	11.00	1.75	11.70	1.92	13.20	2.30	14.60	2.70
	23	7.40	1.13	8.80	1.39	10.30	1.71	11.00	1.90	11.70	2.08	13.20	2.48	14.50	2.94
	25	7.40	1.18	8.80	1.49	10.30	1.85	11.00	2.04	11.70	2.25	13.10	2.69	14.50	3.19
	27	7.40	1.28	8.80	1.61	10.30	2.00	11.00	2.20	11.70	2.42	13.10	2.93	14.30	3.40
	29	7.40	1.36	8.80	1.73	10.30	2.15	10.90	2.39	11.60	2.62	13.10	3.15	14.20	3.55
	31	7.40	1.47	8.80	1.87	10.20	2.33	10.90	2.57	11.60	2.84	13.10	3.42	13.90	3.74
	33	7.40	1.58	8.80	2.01	10.20	2.52	10.90	2.77	11.60	3.07	13.10	3.70	13.70	3.92
	35	7.30	1.68	8.70	2.17	10.20	2.71	10.90	3.01	11.60	3.33	13.10	4.01	13.40	4.13
	37	7.10	1.82	8.50	2.36	9.90	2.94	10.60	3.29	11.20	3.64	12.60	4.34	12.80	4.37
	39	7.00	1.96	8.30	2.54	9.70	3.21	10.30	3.58	11.00	3.96	12.10	4.58	12.30	4.63
80	10	6.60	0.88	7.90	1.04	9.20	1.22	9.80	1.32	10.40	1.41	11.80	1.61	13.00	1.83
	12	6.60	0.89	7.90	1.05	9.20	1.25	9.80	1.35	10.40	1.45	11.70	1.65	13.00	1.87
	14	6.60	0.90	7.90	1.08	9.20	1.28	9.80	1.37	10.40	1.47	11.70	1.69	13.00	1.91
	16	6.60	0.91	7.90	1.12	9.20	1.31	9.80	1.41	10.40	1.51	11.70	1.74	12.90	1.96
	18	6.60	0.94	7.90	1.13	9.20	1.33	9.80	1.43	10.40	1.54	11.70	1.77	12.90	2.00
	20	6.60	0.96	7.90	1.15	9.20	1.36	9.80	1.47	10.40	1.59	11.70	1.84	12.90	2.15
	21	6.60	0.96	7.90	1.17	9.20	1.38	9.80	1.49	10.40	1.61	11.70	1.92	12.90	2.24
	23	6.60	0.99	7.90	1.18	9.10	1.45	9.80	1.60	10.40	1.74	11.70	2.08	12.90	2.43
	25	6.60	1.01	7.80	1.28	9.10	1.56	9.70	1.72	10.40	1.89	11.70	2.23	12.90	2.63
	27	6.60	1.09	7.80	1.37	9.10	1.68	9.70	1.85	10.30	2.04	11.70	2.42	12.90	2.85
	29	6.60	1.17	7.80	1.47	9.10	1.80	9.70	2.00	10.30	2.20	11.60	2.62	12.90	3.09
	31	6.60	1.25	7.80	1.59	9.10	1.95	9.70	2.15	10.30	2.37	11.60	2.84	12.80	3.34
	33	6.60	1.34	7.80	1.71	9.10	2.11	9.70	2.32	10.30	2.55	11.60	3.06	12.80	3.63
	35	6.50	1.46	7.80	1.83	9.10	2.27	9.70	2.51	10.30	2.76	11.60	3.31	12.80	3.92
	37	6.30	1.57	7.60	1.98	8.80	2.46	9.40	2.73	10.00	2.99	11.20	3.61	12.40	4.31
	39	6.20	1.68	7.40	2.14	8.60	2.66	9.20	2.95	9.80	3.28	11.00	3.94	12.10	4.58
70	10	5.80	0.77	6.90	0.91	8.00	1.05	8.60	1.14	9.10	1.22	10.30	1.39	11.40	1.57
	12	5.80	0.78	6.90	0.92	8.00	1.08	8.60	1.16	9.10	1.25	10.30	1.41	11.40	1.60
	14	5.80	0.79	6.90	0.95	8.00	1.10	8.60	1.19	9.10	1.27	10.20	1.45	11.40	1.62
	16	5.80	0.80	6.90	0.96	8.00	1.13	8.60	1.21	9.10	1.30	10.20	1.48	11.40	1.67
	18	5.80	0.81	6.90	0.98	8.00	1.15	8.60	1.23	9.10	1.32	10.20	1.52	11.40	1.71
	20	5.80	0.84	6.90	1.01	8.00	1.17	8.60	1.27	9.10	1.36	10.20	1.54	11.30	1.75
	21	5.80	0.84	6.90	1.01	8.00	1.18	8.50	1.27	9.10	1.38	10.20	1.58	11.30	1.84
	23	5.80	0.85	6.90	1.03	8.00	1.22	8.50	1.33	9.10	1.44	10.20	1.71	11.30	1.99
	25	5.80	0.88	6.90	1.07	8.00	1.31	8.50	1.44	9.00	1.57	10.20	1.83	11.30	2.14
	27	5.70	0.93	6.90	1.15	8.00	1.41	8.50	1.54	9.00	1.67	10.20	1.97	11.30	2.32
	29	5.70	1.00	6.90	1.24	8.00	1.50	8.50	1.65	9.00	1.81	10.20	2.13	11.30	2.50
	31	5.70	1.08	6.80	1.34	8.00	1.62	8.50	1.78	9.00	1.94	10.20	2.30	11.30	2.69
	33	5.70	1.16	6.80	1.43	7.90	1.75	8.50	1.91	9.00	2.10	10.10	2.49	11.30	2.91
	35	5.70	1.22	6.80	1.53	7.90	1.86	8.50	2.05	9.00	2.26	10.10	2.68	11.20	3.16
	37	5.50	1.32	6.60	1.65	7.70	2.02	8.20	2.23	8.70	2.45	9.80	2.92	10.90	3.44
	39	5.40	1.43	6.50	1.78	7.50	2.20	8.00	2.41	8.50	2.65	9.60	3.17	10.70	3.75
60	10	5.00	0.67	5.90	0.79	6.90	0.90	7.40	0.96	7.80	1.03	8.80	1.16	9.70	1.31
	12	5.00	0.68	5.90	0.79	6.90	0.91	7.40	0.99	7.80	1.06	8.80	1.20	9.70	1.34
	14	5.00	0.69	5.90	0.80	6.90	0.95	7.40	1.00	7.80	1.08	8.80	1.21	9.70	1.37
	16	5.00	0.69	5.90	0.83	6.90	0.96	7.30	1.03	7.80	1.09	8.70	1.25	9.70	1.40
	18	5.00	0.72	5.90	0.84	6.90	0.97	7.30	1.04	7.80	1.12	8.70	1.27	9.70	1.42
	20	5.00	0.72	5.90	0.85	6.90	1.00	7.30	1.06	7.80	1.14	8.70	1.29	9.70	1.46
	21	4.90	0.73	5.90	0.86	6.80	1.01	7.30	1.08	7.80	1.16	8.70	1.32	9.70	1.47
	23	4.90	0.76	5.90	0.89	6.80	1.02	7.30	1.10	7.80	1.17	8.70	1.38	9.70	1.59
	25	4.90	0.76	5.90	0.90	6.80	1.07	7.30	1.17	7.80	1.27	8.70	1.48	9.70	1.71
	27	4.90	0.79	5.90	0.96	6.80	1.15	7.30	1.24	7.80	1.36	8.70	1.59	9.70	1.84
	29	4.90	0.85	5.90	1.03	6.80	1.24	7.30	1.35	7.80	1.45	8.70	1.71	9.60	1.98
	31	4.90	0.91	5.90	1.10	6.80	1.32	7.30	1.44	7.80	1.56	8.70	1.83	9.60	2.14
	33	4.90	0.95	5.90	1.18	6.80	1.42	7.30	1.55	7.80	1.69	8.70	1.97	9.60	2.30
	35	4.90	1.02	5.80	1.26	6.80	1.52	7.30	1.66	7.70	1.82	8.60	2.13	9.60	2.49
	37	4.80	1.11	5.70	1.35	6.60	1.65	7.00	1.79	7.50	1.96	8.40	2.31	9.30	2.70
	39	4.70	1.18	5.50	1.45	6.40	1.78	6.90	1.93	7.30	2.12	8.20	2.51	9.10	2.94

10. Capacity Table

Combination, % (Capacity index)	Outdoor temperature (°C, DB)	Indoor temperature (°C, WB)													
		14		16		18		19		20		22		24	
		TC kW	PI kW	TC kW	PI kW	TC kW	PI kW	TC kW	PI kW	TC kW	PI kW	TC kW	PI kW	TC kW	PI kW
50	10	4.10	0.58	4.90	0.67	5.70	0.75	6.10	0.80	6.50	0.85	7.30	0.97	8.10	1.08
	12	4.10	0.59	4.90	0.67	5.70	0.77	6.10	0.82	6.50	0.88	7.30	0.99	8.10	1.10
	14	4.10	0.59	4.90	0.69	5.70	0.79	6.10	0.83	6.50	0.89	7.30	1.00	8.10	1.11
	16	4.10	0.59	4.90	0.69	5.70	0.79	6.10	0.85	6.50	0.90	7.30	1.01	8.10	1.14
	18	4.10	0.61	4.90	0.70	5.70	0.80	6.10	0.87	6.50	0.92	7.30	1.04	8.10	1.16
	20	4.10	0.62	4.90	0.72	5.70	0.83	6.10	0.88	6.50	0.94	7.30	1.06	8.10	1.19
	21	4.10	0.63	4.90	0.73	5.70	0.84	6.10	0.90	6.50	0.95	7.30	1.08	8.10	1.20
	23	4.10	0.64	4.90	0.74	5.70	0.85	6.10	0.91	6.50	0.97	7.30	1.09	8.10	1.23
	25	4.10	0.64	4.90	0.76	5.70	0.87	6.10	0.92	6.50	1.02	7.30	1.17	8.10	1.33
	27	4.10	0.66	4.90	0.78	5.70	0.92	6.10	1.00	6.50	1.08	7.30	1.23	8.10	1.42
	29	4.10	0.71	4.90	0.83	5.70	0.98	6.10	1.06	6.50	1.16	7.30	1.34	8.10	1.53
	31	4.10	0.75	4.90	0.90	5.70	1.06	6.10	1.16	6.50	1.24	7.30	1.43	8.10	1.65
	33	4.10	0.79	4.90	0.95	5.70	1.13	6.10	1.22	6.50	1.32	7.30	1.54	8.00	1.78
	35	4.10	0.84	4.90	1.02	5.70	1.21	6.10	1.32	6.40	1.42	7.20	1.65	8.00	1.90
	37	4.00	0.90	4.70	1.10	5.50	1.29	5.90	1.41	6.30	1.52	7.00	1.79	7.80	2.06
	39	3.90	0.98	4.60	1.17	5.40	1.40	5.70	1.53	6.10	1.65	6.90	1.92	7.60	2.22

NOTE

- Capacity table may be subject to change without prior notice.
- Capacity table comply with EN14511.
- Cooling capacities are based on;
 - Indoor temperature : 27°C DB, 19°C WB
 - Outdoor temperature : 35°C DB, 24°C WB, Equivalent refrigerant piping : 7.5m, Level differences : 0m
- Heating capacities are based on;
 - Indoor temperature : 20°C DB, 15°C WB
 - Outdoor temperature : 7°C DB, 6°C WB, Equivalent refrigerant piping : 7.5m, Level differences : 0m

10. Capacity Table

Heating

TC : Total Capacity, PI : Power Input

Combination, % (Capacity index)	Outdoor temperature (°C, DB)		Indoor temperature (°C, DB)									
			16		18		20		22		24	
			TC	PI	TC	PI	TC	PI	TC	PI	TC	PI
130	DB	WB	kW	kW	kW	kW	kW	kW	kW	kW	kW	kW
	15	14	19.00	3.80	17.80	3.50	16.70	3.22	15.50	2.96	14.40	2.69
	13	12	19.00	3.95	17.80	3.64	16.70	3.34	15.50	3.07	14.40	2.80
	11	10	19.00	4.11	17.80	3.81	16.70	3.49	15.50	3.20	14.40	2.91
	9	8	19.00	4.30	17.80	3.96	16.70	3.64	15.50	3.33	14.40	3.03
	7	6	18.70	4.45	17.80	4.19	16.70	3.83	15.50	3.50	14.40	3.19
	5	4	18.20	4.45	17.80	4.43	16.70	4.07	15.50	3.71	14.40	3.36
	3	2	17.50	4.39	17.40	4.48	16.70	4.26	15.50	3.88	14.40	3.52
	0	-1	16.50	4.31	16.50	4.39	16.40	4.49	15.50	4.18	14.40	3.79
	-3	-4	15.50	4.19	15.40	4.30	15.40	4.39	15.40	4.49	14.40	4.11
	-5	-6	14.80	4.34	14.80	4.45	14.70	4.56	14.70	4.67	14.40	4.60
	-7	-8	14.20	4.24	14.10	4.36	14.10	4.48	14.10	4.60	14.10	4.69
	-10	-11	13.00	4.24	13.00	4.37	13.00	4.50	13.00	4.63	12.80	4.77
	-12	-13	12.30	4.12	12.30	4.26	12.30	4.39	12.20	4.52	12.20	4.67
	-15	-16	11.60	3.99	11.60	4.12	11.60	4.27	11.50	4.41	11.50	4.54
	-17	-18	10.90	3.72	10.90	3.87	10.80	4.01	10.80	4.16	10.80	4.31
-20	-21	10.00	3.46	10.00	3.63	9.80	3.77	9.80	3.94	9.80	4.10	
120	15	14	17.40	3.40	16.40	3.16	15.30	2.90	14.20	2.66	13.20	2.43
	13	12	17.40	3.53	16.40	3.27	15.30	3.02	14.20	2.76	13.20	2.51
	11	10	17.40	3.69	16.40	3.40	15.30	3.13	14.20	2.88	13.20	2.61
	9	8	17.40	3.84	16.40	3.55	15.30	3.26	14.20	2.98	13.20	2.72
	7	6	17.40	4.07	16.40	3.75	15.30	3.44	14.20	3.15	13.20	2.87
	5	4	17.40	4.31	16.40	3.96	15.30	3.64	14.20	3.32	13.20	3.02
	3	2	17.40	4.51	16.40	4.16	15.30	3.81	14.20	3.48	13.20	3.16
	0	-1	16.40	4.42	16.40	4.48	15.30	4.11	14.20	3.75	13.20	3.39
	-3	-4	15.40	4.32	15.40	4.41	15.30	4.47	14.20	4.06	13.20	3.67
	-5	-6	14.70	4.49	14.70	4.58	14.70	4.68	14.20	4.54	13.20	4.09
	-7	-8	14.10	4.39	14.10	4.51	14.10	4.62	14.10	4.71	13.20	4.36
	-10	-11	13.00	4.41	13.00	4.52	12.80	4.66	12.80	4.78	12.80	4.90
	-12	-13	12.30	4.30	12.30	4.42	12.20	4.54	12.20	4.68	12.20	4.81
	-15	-16	11.60	4.18	11.50	4.31	11.50	4.44	11.50	4.58	11.50	4.71
	-17	-18	10.90	3.91	10.80	4.05	10.80	4.19	10.80	4.32	10.80	4.46
	-20	-21	9.80	3.69	9.80	3.83	9.80	3.98	9.80	4.11	9.70	4.28
110	15	14	15.80	3.04	14.80	2.81	13.90	2.59	13.00	2.37	11.90	2.17
	13	12	15.80	3.15	14.80	2.91	13.90	2.68	13.00	2.46	11.90	2.24
	11	10	15.80	3.29	14.80	3.03	13.90	2.79	13.00	2.57	11.90	2.33
	9	8	15.80	3.41	14.80	3.16	13.90	2.90	13.00	2.66	11.90	2.43
	7	6	15.80	3.61	14.80	3.33	13.90	3.06	13.00	2.81	11.90	2.54
	5	4	15.80	3.81	14.80	3.51	13.90	3.22	13.00	2.96	11.90	2.69
	3	2	15.80	3.98	14.80	3.68	13.90	3.38	13.00	3.09	11.90	2.80
	0	-1	15.80	4.31	14.80	3.97	13.90	3.64	13.00	3.32	11.90	3.01
	-3	-4	15.40	4.46	14.80	4.32	13.90	3.95	13.00	3.61	11.90	3.27
	-5	-6	14.70	4.63	14.70	4.71	13.90	4.40	13.00	4.01	11.90	3.63
	-7	-8	14.10	4.56	14.10	4.66	13.90	4.68	13.00	4.26	11.90	3.87
	-10	-11	13.00	4.60	12.80	4.70	12.80	4.81	12.80	4.92	11.90	4.49
	-12	-13	12.20	4.49	12.20	4.61	12.20	4.71	12.20	4.83	11.90	4.82
	-15	-16	11.50	4.37	11.50	4.49	11.50	4.62	11.50	4.73	11.40	4.86
	-17	-18	10.80	4.11	10.80	4.23	10.80	4.36	10.80	4.49	10.70	4.62
	-20	-21	9.80	3.89	9.80	4.03	9.80	4.17	9.70	4.30	9.70	4.45
100	15	14	14.30	2.52	13.40	2.34	12.40	2.16	11.60	1.98	10.70	1.82
	13	12	14.30	2.62	13.40	2.43	12.40	2.29	11.60	2.06	10.70	1.89
	11	10	14.30	2.73	13.40	2.52	12.40	2.55	11.60	2.14	10.70	1.95
	9	8	14.30	2.84	13.40	2.63	12.40	2.74	11.60	2.22	10.70	2.03
	7	6	14.30	3.00	13.40	2.77	12.10	2.90	11.60	2.34	10.70	2.14
	5	4	14.30	3.15	13.40	2.91	12.10	3.05	11.60	2.46	10.70	2.24
	3	2	14.30	3.31	13.40	3.06	12.10	3.14	11.60	2.57	10.70	2.34
	0	-1	14.30	3.55	13.40	3.28	12.10	3.26	11.60	2.75	10.70	2.51
	-3	-4	14.30	3.86	13.40	3.57	12.10	3.39	11.60	2.98	10.70	2.70
	-5	-6	14.30	4.31	13.40	3.95	12.10	3.62	11.60	3.30	10.70	3.00
	-7	-8	14.10	4.43	13.40	4.22	12.10	3.86	11.60	3.50	10.70	3.18
	-10	-11	12.80	4.48	12.80	4.57	12.10	4.49	11.60	4.08	10.70	3.70
	-12	-13	12.20	4.40	12.20	4.49	11.90	4.60	11.60	4.39	10.70	3.96
	-15	-16	11.50	4.30	11.50	4.40	11.50	4.50	11.40	4.61	10.70	4.26
	-17	-18	10.80	4.05	10.80	4.16	10.70	4.26	10.70	4.37	10.70	4.47
	-20	-21	9.80	3.86	9.70	3.99	9.70	4.09	9.70	4.23	9.70	4.34

10. Capacity Table

Combination, % (Capacity index)	Outdoor temperature (°C, DB)		Indoor temperature (°C, DB)										
			16		18		20		22		24		
			TC	PI	TC	PI	TC	PI	TC	PI	TC	PI	
	DB	WB	kW	kW	kW	kW	kW	kW	kW	kW	kW		
90	15	14	12.70	2.34	11.90	2.17	11.20	2.00	10.30	1.84	9.50	1.69	
	13	12	12.70	2.43	11.90	2.24	11.20	2.08	10.30	1.90	9.50	1.75	
	11	10	12.70	2.52	11.90	2.33	11.20	2.16	10.30	1.97	9.50	1.80	
	9	8	12.70	2.62	11.90	2.43	11.20	2.23	10.30	2.05	9.50	1.87	
	7	6	12.70	2.75	11.90	2.54	11.20	2.35	10.30	2.16	9.50	1.96	
	5	4	12.70	2.91	11.90	2.69	11.20	2.47	10.30	2.28	9.50	2.07	
	3	2	12.70	3.04	11.90	2.80	11.20	2.58	10.30	2.36	9.50	2.16	
	0	-1	12.70	3.27	11.90	3.01	11.20	2.77	10.30	2.54	9.50	2.30	
	-3	-4	12.70	3.53	11.90	3.26	11.20	2.99	10.30	2.74	9.50	2.48	
	-5	-6	12.70	3.94	11.90	3.62	11.20	3.32	10.30	3.04	9.50	2.76	
	-7	-8	12.70	4.18	11.90	3.86	11.20	3.52	10.30	3.21	9.50	2.91	
	-10	-11	12.70	4.88	11.90	4.48	11.20	4.10	10.30	3.74	9.50	3.39	
	-12	-13	12.20	4.86	11.90	4.82	11.20	4.40	10.30	4.01	9.50	3.62	
	-15	-16	11.50	4.77	11.40	4.86	11.20	4.76	10.30	4.32	9.50	3.89	
	-17	-18	10.70	4.51	10.70	4.62	10.70	4.71	10.30	4.53	9.50	4.08	
	-20	-21	9.70	4.34	9.70	4.45	9.70	4.55	9.70	4.68	9.50	4.65	
	80	15	14	11.20	2.01	10.40	1.87	9.70	1.73	9.00	1.59	8.30	1.46
		13	12	11.20	2.08	10.40	1.93	9.70	1.79	9.00	1.64	8.30	1.51
		11	10	11.20	2.17	10.40	2.01	9.70	1.86	9.00	1.71	8.30	1.57
		9	8	11.20	2.24	10.40	2.07	9.70	1.93	9.00	1.77	8.30	1.61
7		6	11.20	2.36	10.40	2.19	9.70	2.02	9.00	1.86	8.30	1.70	
5		4	11.20	2.48	10.40	2.30	9.70	2.13	9.00	1.95	8.30	1.78	
3		2	11.20	2.59	10.40	2.40	9.70	2.21	9.00	2.03	8.30	1.85	
0		-1	11.20	2.79	10.40	2.57	9.70	2.36	9.00	2.17	8.30	1.98	
-3		-4	11.20	3.00	10.40	2.78	9.70	2.55	9.00	2.33	8.30	2.13	
-5		-6	11.20	3.34	10.40	3.08	9.70	2.83	9.00	2.59	8.30	2.35	
-7		-8	11.20	3.55	10.40	3.28	9.70	3.00	9.00	2.74	8.30	2.49	
-10		-11	11.20	4.12	10.40	3.79	9.70	3.47	9.00	3.16	8.30	2.87	
-12		-13	11.20	4.42	10.40	4.06	9.70	3.72	9.00	3.40	8.30	3.06	
-15		-16	11.20	4.78	10.40	4.37	9.70	4.01	9.00	3.64	8.30	3.29	
-17		-18	10.70	4.71	10.40	4.61	9.70	4.20	9.00	3.82	8.30	3.44	
-20		-21	9.70	4.55	9.70	4.65	9.70	4.77	9.00	4.35	8.30	3.90	
70		15	14	9.60	1.71	9.00	1.58	8.30	1.47	7.70	1.34	7.10	1.24
		13	12	9.60	1.76	9.00	1.63	8.30	1.52	7.70	1.39	7.10	1.29
		11	10	9.60	1.82	9.00	1.70	8.30	1.57	7.70	1.45	7.10	1.32
		9	8	9.60	1.89	9.00	1.76	8.30	1.62	7.70	1.49	7.10	1.37
	7	6	9.60	1.99	9.00	1.85	8.30	1.71	7.70	1.57	7.10	1.43	
	5	4	9.60	2.09	9.00	1.93	8.30	1.78	7.70	1.64	7.10	1.50	
	3	2	9.60	2.17	9.00	2.02	8.30	1.86	7.70	1.71	7.10	1.57	
	0	-1	9.60	2.32	9.00	2.15	8.30	1.99	7.70	1.82	7.10	1.66	
	-3	-4	9.60	2.50	9.00	2.32	8.30	2.14	7.70	1.96	7.10	1.78	
	-5	-6	9.60	2.78	9.00	2.57	8.30	2.37	7.70	2.16	7.10	1.97	
	-7	-8	9.60	2.95	9.00	2.72	8.30	2.51	7.70	2.28	7.10	2.08	
	-10	-11	9.60	3.42	9.00	3.14	8.30	2.89	7.70	2.64	7.10	2.39	
	-12	-13	9.60	3.65	9.00	3.36	8.30	3.09	7.70	2.81	7.10	2.54	
	-15	-16	9.60	3.93	9.00	3.61	8.30	3.30	7.70	3.01	7.10	2.72	
	-17	-18	9.60	4.14	9.00	3.79	8.30	3.45	7.70	3.15	7.10	2.84	
	-20	-21	9.60	4.70	9.00	4.31	8.30	3.92	7.70	3.56	7.10	3.22	
	60	15	14	8.00	1.41	7.50	1.32	6.90	1.21	6.40	1.11	5.90	1.03
		13	12	8.00	1.45	7.50	1.35	6.90	1.24	6.40	1.16	5.90	1.06
		11	10	8.00	1.50	7.50	1.40	6.90	1.30	6.40	1.20	5.90	1.09
		9	8	8.00	1.57	7.50	1.44	6.90	1.34	6.40	1.23	5.90	1.14
7		6	8.00	1.63	7.50	1.52	6.90	1.40	6.40	1.30	5.90	1.18	
5		4	8.00	1.72	7.50	1.59	6.90	1.47	6.40	1.35	5.90	1.25	
3		2	8.00	1.79	7.50	1.65	6.90	1.53	6.40	1.41	5.90	1.29	
0		-1	8.00	1.90	7.50	1.77	6.90	1.62	6.40	1.49	5.90	1.36	
-3		-4	8.00	2.04	7.50	1.89	6.90	1.74	6.40	1.60	5.90	1.45	
-5		-6	8.00	2.26	7.50	2.09	6.90	1.94	6.40	1.78	5.90	1.61	
-7		-8	8.00	2.39	7.50	2.21	6.90	2.02	6.40	1.86	5.90	1.69	
-10		-11	8.00	2.75	7.50	2.54	6.90	2.34	6.40	2.13	5.90	1.94	
-12		-13	8.00	2.95	7.50	2.71	6.90	2.50	6.40	2.27	5.90	2.06	
-15		-16	8.00	3.16	7.50	2.91	6.90	2.66	6.40	2.43	5.90	2.21	
-17		-18	8.00	3.31	7.50	3.03	6.90	2.78	6.40	2.53	5.90	2.28	
-20		-21	8.00	3.74	7.50	3.43	6.90	3.14	6.40	2.85	5.90	2.58	

10. Capacity Table

Combination, % (Capacity index)	Outdoor temperature (°C, DB)		Indoor temperature (°C, DB)									
			16		18		20		22		24	
			TC	PI	TC	PI	TC	PI	TC	PI	TC	PI
50	DB	WB	kW	kW	kW	kW	kW	kW	kW	kW	kW	kW
	15	14	6.40	1.13	6.00	1.06	5.60	0.97	5.10	0.90	4.70	0.82
	13	12	6.40	1.17	6.00	1.08	5.60	1.01	5.10	0.93	4.70	0.85
	11	10	6.40	1.20	6.00	1.12	5.60	1.04	5.10	0.95	4.70	0.88
	9	8	6.40	1.24	6.00	1.16	5.60	1.07	5.10	0.99	4.70	0.90
	7	6	6.40	1.30	6.00	1.21	5.60	1.12	5.10	1.03	4.70	0.95
	5	4	6.40	1.35	6.00	1.27	5.60	1.17	5.10	1.08	4.70	0.98
	3	2	6.40	1.42	6.00	1.31	5.60	1.21	5.10	1.12	4.70	1.02
	0	-1	6.40	1.49	6.00	1.40	5.60	1.28	5.10	1.18	4.70	1.09
	-3	-4	6.40	1.60	6.00	1.49	5.60	1.38	5.10	1.26	4.70	1.15
	-5	-6	6.40	1.79	6.00	1.65	5.60	1.52	5.10	1.38	4.70	1.27
	-7	-8	6.40	1.87	6.00	1.73	5.60	1.59	5.10	1.46	4.70	1.33
	-10	-11	6.40	2.14	6.00	1.98	5.60	1.83	5.10	1.67	4.70	1.51
	-12	-13	6.40	2.29	6.00	2.10	5.60	1.94	5.10	1.78	4.70	1.61
	-15	-16	6.40	2.44	6.00	2.25	5.60	2.07	5.10	1.89	4.70	1.72
	-17	-18	6.40	2.54	6.00	2.34	5.60	2.15	5.10	1.95	4.70	1.77
	-20	-21	6.40	2.86	6.00	2.64	5.60	2.41	5.10	2.19	4.70	1.98

NOTE

- Capacity table may be subject to change without prior notice.
- Capacity table comply with EN14511.
- Cooling capacities are based on;
 - Indoor temperature : 27°C DB, 19°C WB
 - Outdoor temperature : 35°C DB, 24°C WB, Equivalent refrigerant piping : 7.5m, Level differences : 0m
- Heating capacities are based on;
 - Indoor temperature : 20°C DB, 15°C WB
 - Outdoor temperature : 7°C DB, 6°C WB, Equivalent refrigerant piping : 7.5m, Level differences : 0m

10. Capacity Table

AM050KXMDEH/EU

Cooling

TC : Total Capacity, PI : Power Input

Combination, % (Capacity index)	Outdoor temperature (°C, DB)	Indoor temperature (°C, WB)													
		14		16		18		19		20		22		24	
		TC kW	PI kW	TC kW	PI kW	TC kW	PI kW	TC kW	PI kW	TC kW	PI kW	TC kW	PI kW	TC kW	PI kW
130	10	12.50	1.75	14.80	2.15	17.30	2.55	18.50	2.76	19.40	2.91	19.90	2.77	20.30	2.63
	12	12.50	1.78	14.80	2.18	17.20	2.62	18.50	2.81	19.20	2.89	19.60	2.75	20.10	2.70
	14	12.50	1.82	14.80	2.24	17.20	2.66	18.40	2.87	18.80	2.87	19.40	2.84	19.80	2.86
	16	12.50	1.86	14.80	2.28	17.20	2.71	18.40	2.97	18.60	2.98	19.00	3.00	19.50	3.03
	18	12.40	1.89	14.80	2.33	17.20	2.90	18.10	3.13	18.30	3.14	18.80	3.16	19.20	3.18
	20	12.40	1.94	14.80	2.49	17.20	3.13	17.90	3.29	18.10	3.30	18.50	3.32	19.00	3.36
	21	12.40	1.99	14.70	2.58	17.20	3.26	17.70	3.38	18.00	3.39	18.40	3.41	18.90	3.44
	23	12.40	2.14	14.70	2.77	17.10	3.51	17.40	3.54	17.60	3.56	18.10	3.58	18.60	3.61
	25	12.40	2.30	14.70	2.98	16.90	3.69	17.20	3.71	17.40	3.73	17.80	3.76	18.30	3.78
	27	12.40	2.47	14.70	3.21	16.70	3.86	16.90	3.87	17.10	3.89	17.60	3.93	18.00	3.96
	29	12.40	2.64	14.70	3.44	16.40	4.03	16.70	4.05	16.90	4.08	17.30	4.11	17.80	4.13
	31	12.40	2.82	14.70	3.70	16.20	4.21	16.40	4.23	16.60	4.25	17.10	4.27	17.50	4.32
	33	12.30	3.03	14.60	3.97	15.90	4.39	16.20	4.41	16.40	4.43	16.80	4.46	17.30	4.50
	35	12.30	3.24	14.60	4.26	15.60	4.57	15.80	4.58	16.00	4.61	16.50	4.65	16.90	4.70
	37	11.90	3.49	14.20	4.58	14.80	4.77	15.10	4.79	15.30	4.81	15.70	4.86	16.20	4.89
	39	11.70	3.73	13.90	4.92	14.40	4.97	14.50	4.98	14.70	5.01	15.20	5.05	15.60	5.09
120	10	11.50	1.61	13.70	1.95	15.90	2.33	17.10	2.52	18.20	2.71	19.60	2.86	20.00	2.74
	12	11.50	1.63	13.70	1.99	15.90	2.37	17.00	2.56	18.20	2.76	19.30	2.85	19.70	2.72
	14	11.50	1.66	13.70	2.04	15.90	2.43	17.00	2.62	18.10	2.82	19.00	2.83	19.50	2.85
	16	11.40	1.69	13.70	2.07	15.90	2.47	17.00	2.68	18.10	2.89	18.70	2.99	19.10	3.01
	18	11.40	1.74	13.70	2.13	15.90	2.56	17.00	2.84	18.10	3.13	18.50	3.14	18.90	3.17
	20	11.40	1.76	13.60	2.20	15.90	2.76	17.00	3.07	17.80	3.28	18.20	3.31	18.60	3.33
	21	11.40	1.78	13.60	2.29	15.80	2.87	17.00	3.19	17.70	3.38	18.10	3.39	18.50	3.42
	23	11.40	1.91	13.60	2.46	15.80	3.08	16.90	3.43	17.30	3.54	17.80	3.56	18.20	3.59
	25	11.40	2.05	13.60	2.65	15.80	3.33	16.90	3.69	17.10	3.71	17.50	3.73	17.90	3.77
	27	11.40	2.20	13.60	2.85	15.80	3.57	16.60	3.87	16.80	3.87	17.30	3.90	17.70	3.93
	29	11.40	2.35	13.60	3.06	15.80	3.83	16.40	4.03	16.60	4.05	17.00	4.08	17.40	4.12
	31	11.40	2.52	13.60	3.26	15.80	4.12	16.10	4.21	16.30	4.22	16.80	4.25	17.20	4.28
	33	11.30	2.69	13.50	3.51	15.70	4.37	15.90	4.38	16.10	4.40	16.50	4.44	16.90	4.47
	35	11.30	2.89	13.50	3.75	15.30	4.55	15.50	4.57	15.80	4.58	16.20	4.62	16.60	4.66
	37	11.00	3.09	13.10	4.04	14.70	4.74	14.80	4.77	15.00	4.78	15.40	4.82	15.80	4.86
	39	10.70	3.32	12.80	4.34	14.10	4.95	14.40	4.96	14.50	4.98	14.90	5.03	15.30	5.06
110	10	10.60	1.45	12.60	1.77	14.60	2.11	15.60	2.28	16.70	2.44	18.70	2.80	19.60	2.85
	12	10.60	1.48	12.60	1.81	14.60	2.14	15.60	2.32	16.60	2.50	18.70	2.86	19.40	2.83
	14	10.50	1.50	12.60	1.84	14.60	2.19	15.60	2.38	16.60	2.55	18.60	2.91	19.00	2.83
	16	10.50	1.54	12.60	1.88	14.60	2.24	15.60	2.42	16.60	2.60	18.40	2.97	18.80	3.00
	18	10.50	1.57	12.50	1.92	14.60	2.28	15.60	2.48	16.60	2.74	18.20	3.13	18.50	3.16
	20	10.50	1.60	12.50	1.96	14.50	2.43	15.60	2.68	16.60	2.95	17.90	3.29	18.30	3.32
	21	10.50	1.62	12.50	2.01	14.50	2.51	15.50	2.78	16.60	3.07	17.80	3.37	18.20	3.39
	23	10.50	1.70	12.50	2.17	14.50	2.71	15.50	3.00	16.50	3.31	17.40	3.54	17.80	3.56
	25	10.50	1.82	12.50	2.34	14.50	2.91	15.50	3.22	16.50	3.56	17.20	3.71	17.60	3.74
	27	10.50	1.94	12.50	2.49	14.50	3.12	15.50	3.47	16.50	3.82	16.90	3.88	17.30	3.91
	29	10.50	2.09	12.50	2.67	14.50	3.36	15.50	3.72	16.30	4.02	16.70	4.06	17.10	4.08
	31	10.40	2.23	12.50	2.87	14.50	3.59	15.50	4.00	16.10	4.20	16.40	4.23	16.80	4.27
	33	10.40	2.37	12.40	3.08	14.40	3.86	15.50	4.29	15.80	4.37	16.20	4.41	16.60	4.43
	35	10.40	2.55	12.40	3.29	14.40	4.14	15.30	4.55	15.50	4.57	15.80	4.59	16.20	4.63
	37	10.10	2.72	12.00	3.53	14.00	4.45	14.60	4.75	14.70	4.76	15.10	4.79	15.50	4.83
	39	9.90	2.92	11.80	3.79	13.70	4.79	14.10	4.94	14.30	4.95	14.60	4.99	14.90	5.03
100	10	9.60	1.31	11.50	1.58	13.30	1.88	14.20	2.04	15.10	2.19	17.00	2.51	18.90	2.82
	12	9.60	1.33	11.50	1.63	13.30	1.92	14.20	2.08	15.10	2.24	16.90	2.55	18.90	2.88
	14	9.60	1.36	11.50	1.65	13.30	1.95	14.20	2.12	15.10	2.28	16.90	2.61	18.70	2.92
	16	9.60	1.38	11.40	1.69	13.30	2.00	14.20	2.17	15.10	2.32	16.90	2.66	18.40	2.97
	18	9.60	1.41	11.40	1.72	13.20	2.04	14.20	2.21	15.10	2.38	16.90	2.82	18.20	3.13
	20	9.50	1.44	11.40	1.76	13.20	2.11	14.10	2.32	15.10	2.56	16.90	3.05	17.90	3.29
	21	9.50	1.45	11.40	1.77	13.20	2.18	14.10	2.41	15.00	2.64	16.90	3.16	17.80	3.39
	23	9.50	1.50	11.40	1.89	13.20	2.35	14.10	2.59	15.00	2.86	16.80	3.41	17.50	3.55
	25	9.50	1.60	11.40	2.03	13.20	2.52	14.10	2.79	15.00	3.07	16.80	3.67	17.20	3.72
	27	9.50	1.71	11.40	2.18	13.20	2.71	14.10	2.99	15.00	3.30	16.60	3.87	17.00	3.88
	29	9.50	1.83	11.40	2.34	13.20	2.90	14.10	3.22	15.00	3.54	16.40	4.03	16.70	4.06
	31	9.50	1.96	11.40	2.50	13.20	3.12	14.10	3.45	15.00	3.80	16.10	4.21	16.50	4.23
	33	9.50	2.09	11.30	2.67	13.10	3.33	14.00	3.69	14.90	4.08	15.90	4.38	16.20	4.42
	35	9.50	2.23	11.30	2.85	13.10	3.57	14.00	4.00	14.90	4.38	15.50	4.57	15.90	4.59
	37	9.20	2.38	11.00	3.06	12.70	3.83	13.60	4.26	14.50	4.70	14.80	4.77	15.10	4.80
	39	9.00	2.54	10.70	3.28	12.50	4.11	13.30	4.59	14.00	4.93	14.30	4.96	14.60	4.99

10. Capacity Table

Combination, % (Capacity index)	Outdoor temperature (°C, DB)	Indoor temperature (°C, WB)													
		14		16		18		19		20		22		24	
		TC	PI	TC	PI	TC	PI	TC	PI	TC	PI	TC	PI	TC	PI
90	10	8.60	1.18	10.30	1.42	12.00	1.68	12.80	1.80	13.60	1.94	15.30	2.21	17.00	2.50
	12	8.60	1.20	10.20	1.44	12.00	1.70	12.80	1.84	13.60	1.98	15.30	2.26	16.90	2.55
	14	8.60	1.21	10.20	1.47	12.00	1.74	12.80	1.88	13.60	2.02	15.30	2.31	16.90	2.61
	16	8.60	1.24	10.20	1.50	11.90	1.77	12.80	1.91	13.60	2.06	15.30	2.36	16.90	2.65
	18	8.60	1.26	10.20	1.53	11.90	1.81	12.70	1.95	13.60	2.10	15.30	2.40	16.90	2.82
	20	8.60	1.29	10.20	1.56	11.90	1.84	12.70	2.00	13.50	2.19	15.30	2.59	16.90	3.04
	21	8.60	1.30	10.20	1.57	11.90	1.89	12.70	2.07	13.50	2.26	15.20	2.70	16.90	3.15
	23	8.60	1.33	10.20	1.64	11.90	2.01	12.70	2.22	13.50	2.44	15.20	2.90	16.80	3.41
	25	8.60	1.40	10.20	1.76	11.90	2.16	12.70	2.39	13.50	2.62	15.20	3.11	16.80	3.67
	27	8.60	1.50	10.20	1.88	11.90	2.32	12.70	2.56	13.50	2.81	15.20	3.35	16.60	3.87
	29	8.50	1.59	10.20	2.01	11.90	2.48	12.70	2.74	13.50	3.01	15.20	3.59	16.40	4.03
	31	8.50	1.71	10.10	2.16	11.90	2.66	12.70	2.93	13.50	3.23	15.20	3.86	16.10	4.21
	33	8.50	1.81	10.10	2.30	11.80	2.86	12.60	3.14	13.40	3.46	15.20	4.14	15.90	4.38
	35	8.50	1.92	10.10	2.46	11.80	3.05	12.60	3.37	13.40	3.72	15.10	4.45	15.50	4.57
	37	8.30	2.05	9.80	2.64	11.50	3.27	12.20	3.63	13.00	3.99	14.60	4.74	14.80	4.77
	39	8.10	2.20	9.60	2.81	11.20	3.52	12.00	3.89	12.70	4.29	14.00	4.93	14.30	4.96
80	10	7.70	1.04	9.20	1.25	10.70	1.46	11.40	1.57	12.10	1.69	13.60	1.93	15.00	2.18
	12	7.70	1.06	9.20	1.26	10.70	1.49	11.40	1.61	12.10	1.73	13.60	1.97	15.00	2.23
	14	7.70	1.07	9.10	1.29	10.60	1.52	11.40	1.64	12.10	1.75	13.60	2.01	15.00	2.27
	16	7.70	1.10	9.10	1.33	10.60	1.56	11.30	1.67	12.00	1.80	13.60	2.06	15.00	2.31
	18	7.60	1.12	9.10	1.34	10.60	1.58	11.30	1.70	12.00	1.83	13.60	2.09	15.00	2.37
	20	7.60	1.14	9.10	1.37	10.60	1.61	11.30	1.75	12.00	1.88	13.50	2.18	15.00	2.53
	21	7.60	1.14	9.10	1.38	10.60	1.63	11.30	1.76	12.00	1.91	13.50	2.26	14.90	2.63
	23	7.60	1.17	9.10	1.40	10.60	1.71	11.30	1.88	12.00	2.05	13.50	2.43	14.90	2.84
	25	7.60	1.21	9.10	1.51	10.60	1.83	11.30	2.01	12.00	2.21	13.50	2.60	14.90	3.05
	27	7.60	1.28	9.10	1.61	10.60	1.96	11.30	2.16	12.00	2.36	13.50	2.80	14.90	3.28
	29	7.60	1.37	9.10	1.71	10.60	2.10	11.30	2.32	12.00	2.53	13.50	3.00	14.90	3.52
	31	7.60	1.46	9.10	1.84	10.50	2.25	11.20	2.48	12.00	2.71	13.50	3.22	14.90	3.77
	33	7.60	1.56	9.10	1.96	10.50	2.41	11.20	2.65	11.90	2.90	13.40	3.45	14.80	4.05
	35	7.60	1.66	9.00	2.09	10.50	2.57	11.20	2.83	11.90	3.11	13.40	3.70	14.80	4.35
	37	7.30	1.77	8.80	2.23	10.20	2.76	10.90	3.04	11.50	3.33	13.00	3.97	14.40	4.68
	39	7.20	1.89	8.60	2.39	10.00	2.94	10.60	3.25	11.30	3.59	12.70	4.27	14.00	4.93
70	10	6.70	0.92	8.00	1.08	9.30	1.26	10.00	1.36	10.60	1.46	11.90	1.66	13.20	1.87
	12	6.70	0.93	8.00	1.10	9.30	1.29	9.90	1.39	10.60	1.49	11.90	1.69	13.20	1.90
	14	6.70	0.95	8.00	1.13	9.30	1.31	9.90	1.42	10.50	1.51	11.90	1.72	13.20	1.93
	16	6.70	0.96	8.00	1.14	9.30	1.34	9.90	1.44	10.50	1.55	11.80	1.76	13.20	1.99
	18	6.70	0.97	8.00	1.17	9.30	1.37	9.90	1.46	10.50	1.57	11.80	1.80	13.10	2.02
	20	6.70	0.99	8.00	1.19	9.30	1.39	9.90	1.51	10.50	1.61	11.80	1.83	13.10	2.08
	21	6.70	1.00	8.00	1.20	9.20	1.40	9.90	1.51	10.50	1.63	11.80	1.87	13.10	2.16
	23	6.70	1.01	8.00	1.22	9.20	1.44	9.90	1.57	10.50	1.70	11.80	2.01	13.10	2.33
	25	6.70	1.04	8.00	1.27	9.20	1.53	9.90	1.68	10.50	1.83	11.80	2.14	13.10	2.50
	27	6.70	1.10	7.90	1.36	9.20	1.64	9.90	1.79	10.50	1.95	11.80	2.30	13.10	2.68
	29	6.60	1.17	7.90	1.46	9.20	1.76	9.90	1.92	10.50	2.09	11.80	2.47	13.10	2.87
	31	6.60	1.25	7.90	1.55	9.20	1.88	9.80	2.05	10.40	2.24	11.80	2.64	13.10	3.08
	33	6.60	1.34	7.90	1.65	9.20	2.00	9.80	2.19	10.40	2.40	11.70	2.82	13.00	3.30
	35	6.60	1.41	7.90	1.75	9.20	2.13	9.80	2.34	10.40	2.56	11.70	3.02	13.00	3.53
	37	6.40	1.50	7.70	1.87	8.90	2.29	9.50	2.51	10.10	2.74	11.40	3.24	12.60	3.79
	39	6.30	1.61	7.50	2.00	8.70	2.44	9.30	2.68	9.90	2.93	11.10	3.47	12.40	4.07
60	10	5.80	0.79	6.90	0.94	8.00	1.07	8.50	1.16	9.10	1.24	10.20	1.40	11.30	1.56
	12	5.80	0.81	6.90	0.95	8.00	1.09	8.50	1.18	9.10	1.26	10.10	1.43	11.30	1.60
	14	5.70	0.82	6.90	0.96	8.00	1.13	8.50	1.20	9.10	1.28	10.10	1.45	11.20	1.63
	16	5.70	0.82	6.80	0.98	7.90	1.14	8.50	1.22	9.10	1.30	10.10	1.48	11.20	1.66
	18	5.70	0.85	6.80	1.00	7.90	1.16	8.50	1.24	9.10	1.33	10.10	1.51	11.20	1.69
	20	5.70	0.86	6.80	1.01	7.90	1.18	8.50	1.26	9.00	1.36	10.10	1.54	11.20	1.73
	21	5.70	0.87	6.80	1.02	7.90	1.19	8.50	1.28	9.00	1.37	10.10	1.56	11.20	1.75
	23	5.70	0.89	6.80	1.05	7.90	1.21	8.50	1.31	9.00	1.39	10.10	1.63	11.20	1.87
	25	5.70	0.89	6.80	1.07	7.90	1.27	8.50	1.37	9.00	1.49	10.10	1.74	11.20	2.00
	27	5.70	0.93	6.80	1.13	7.90	1.35	8.50	1.46	9.00	1.59	10.10	1.86	11.20	2.15
	29	5.70	0.99	6.80	1.21	7.90	1.45	8.40	1.58	9.00	1.70	10.10	1.98	11.20	2.28
	31	5.70	1.06	6.80	1.28	7.90	1.54	8.40	1.68	9.00	1.81	10.00	2.12	11.10	2.45
	33	5.70	1.11	6.80	1.36	7.90	1.64	8.40	1.79	9.00	1.94	10.00	2.27	11.10	2.61
	35	5.70	1.18	6.80	1.45	7.90	1.74	8.40	1.90	9.00	2.06	10.00	2.43	11.10	2.81
	37	5.50	1.26	6.60	1.54	7.60	1.87	8.20	2.03	8.70	2.21	9.70	2.60	10.80	3.00
	39	5.40	1.34	6.40	1.64	7.50	1.99	8.00	2.16	8.50	2.36	9.50	2.78	10.60	3.22

10. Capacity Table

Combination, % (Capacity index)	Outdoor temperature (°C, DB)	Indoor temperature (°C, WB)													
		14		16		18		19		20		22		24	
		TC kW	PI kW	TC kW	PI kW	TC kW	PI kW	TC kW	PI kW	TC kW	PI kW	TC kW	PI kW	TC kW	PI kW
50	10	4.80	0.69	5.70	0.79	6.60	0.91	7.10	0.96	7.60	1.02	8.50	1.16	9.40	1.28
	12	4.80	0.70	5.70	0.80	6.60	0.92	7.10	0.98	7.60	1.04	8.50	1.18	9.40	1.31
	14	4.80	0.71	5.70	0.82	6.60	0.94	7.10	1.00	7.60	1.06	8.50	1.20	9.40	1.32
	16	4.80	0.71	5.70	0.82	6.60	0.95	7.10	1.01	7.60	1.07	8.50	1.21	9.40	1.36
	18	4.80	0.72	5.70	0.84	6.60	0.96	7.10	1.03	7.50	1.10	8.50	1.24	9.40	1.38
	20	4.80	0.73	5.70	0.86	6.60	0.98	7.10	1.06	7.50	1.12	8.50	1.26	9.40	1.41
	21	4.80	0.74	5.70	0.87	6.60	0.99	7.10	1.07	7.50	1.13	8.50	1.28	9.40	1.42
	23	4.80	0.75	5.70	0.88	6.60	1.02	7.10	1.08	7.50	1.15	8.40	1.30	9.40	1.46
	25	4.80	0.77	5.70	0.89	6.60	1.03	7.10	1.10	7.50	1.20	8.40	1.38	9.30	1.57
	27	4.80	0.78	5.70	0.92	6.60	1.08	7.00	1.18	7.50	1.27	8.40	1.45	9.30	1.67
	29	4.70	0.83	5.70	0.98	6.60	1.16	7.00	1.25	7.50	1.35	8.40	1.56	9.30	1.78
	31	4.70	0.88	5.70	1.05	6.60	1.24	7.00	1.34	7.50	1.44	8.40	1.66	9.30	1.91
	33	4.70	0.92	5.70	1.11	6.60	1.32	7.00	1.42	7.50	1.53	8.40	1.78	9.30	2.04
	35	4.70	0.98	5.60	1.18	6.50	1.40	7.00	1.51	7.50	1.63	8.40	1.89	9.30	2.17
	37	4.60	1.04	5.50	1.25	6.30	1.48	6.80	1.61	7.20	1.74	8.10	2.02	9.00	2.32
	39	4.50	1.11	5.40	1.33	6.20	1.58	6.70	1.71	7.10	1.86	8.00	2.15	8.80	2.48

NOTE

- Capacity table may be subject to change without prior notice.
- Capacity table comply with EN14511.
- Cooling capacities are based on;
 - Indoor temperature : 27°C DB, 19°C WB
 - Outdoor temperature : 35°C DB, 24°C WB, Equivalent refrigerant piping : 7.5m, Level differences : 0m
- Heating capacities are based on;
 - Indoor temperature : 20°C DB, 15°C WB
 - Outdoor temperature : 7°C DB, 6°C WB, Equivalent refrigerant piping : 7.5m, Level differences : 0m

10. Capacity Table

Heating

TC : Total Capacity, PI : Power Input

Combination, % (Capacity index)	Outdoor temperature (°C, DB)		Indoor temperature (°C, DB)									
			16		18		20		22		24	
	DB	WB	TC kW	PI kW	TC kW	PI kW	TC kW	PI kW	TC kW	PI kW	TC kW	PI kW
130	15	14	20.90	4.43	20.80	4.51	19.40	4.15	18.10	3.79	16.60	3.45
	13	12	20.20	4.37	20.20	4.47	19.40	4.32	18.10	3.95	16.60	3.58
	11	10	19.50	4.32	19.40	4.41	19.40	4.49	18.10	4.11	16.60	3.74
	9	8	18.90	4.25	18.80	4.35	18.80	4.45	18.10	4.28	16.60	3.89
	7	6	18.20	4.24	18.20	4.34	18.20	4.44	18.10	4.52	16.60	4.10
	5	4	17.60	4.21	17.60	4.32	17.50	4.43	17.50	4.53	16.60	4.33
	3	2	17.00	4.14	16.90	4.25	16.90	4.35	16.90	4.48	16.60	4.53
	0	-1	15.90	4.01	15.90	4.13	15.80	4.25	15.80	4.36	15.80	4.48
	-3	-4	14.90	3.87	14.90	4.00	14.90	4.12	14.80	4.23	14.80	4.36
	-5	-6	14.30	3.98	14.30	4.11	14.20	4.24	14.20	4.39	14.20	4.52
	-7	-8	13.70	3.86	13.60	4.00	13.60	4.14	13.50	4.28	13.50	4.42
	-10	-11	12.40	3.78	12.40	3.94	12.40	4.10	12.30	4.25	12.30	4.41
	-12	-13	11.80	3.63	11.70	3.79	11.70	3.95	11.70	4.13	11.60	4.28
	-15	-16	11.10	3.45	11.10	3.63	11.00	3.80	11.00	3.97	11.00	4.15
	-17	-18	10.50	3.16	10.40	3.33	10.40	3.52	10.30	3.69	10.30	3.87
	-20	-21	9.40	2.85	9.30	3.03	9.30	3.22	9.30	3.42	9.20	3.61
120	15	14	20.40	4.38	19.00	4.06	17.80	3.73	16.50	3.42	15.20	3.10
	13	12	20.20	4.50	19.00	4.21	17.80	3.87	16.50	3.54	15.20	3.22
	11	10	19.40	4.44	19.00	4.39	17.80	4.04	16.50	3.68	15.20	3.35
	9	8	18.80	4.39	18.80	4.48	17.80	4.20	16.50	3.84	15.20	3.49
	7	6	18.20	4.37	18.10	4.47	17.80	4.44	16.50	4.05	15.20	3.67
	5	4	17.60	4.36	17.50	4.46	17.50	4.55	16.50	4.27	15.20	3.88
	3	2	16.90	4.29	16.90	4.39	16.90	4.49	16.50	4.47	15.20	4.05
	0	-1	15.90	4.16	15.80	4.28	15.80	4.38	15.80	4.49	15.20	4.36
	-3	-4	14.90	4.04	14.90	4.15	14.80	4.27	14.80	4.38	14.80	4.49
	-5	-6	14.30	4.16	14.20	4.28	14.20	4.41	14.20	4.53	14.10	4.66
	-7	-8	13.60	4.05	13.60	4.18	13.50	4.30	13.50	4.44	13.50	4.58
	-10	-11	12.40	3.99	12.30	4.14	12.30	4.29	12.30	4.43	12.20	4.59
	-12	-13	11.70	3.84	11.70	3.99	11.70	4.16	11.60	4.31	11.60	4.47
	-15	-16	11.10	3.69	11.00	3.84	11.00	4.00	11.00	4.17	10.90	4.33
	-17	-18	10.40	3.39	10.40	3.56	10.30	3.72	10.30	3.89	10.30	4.06
	-20	-21	9.30	3.09	9.30	3.27	9.30	3.45	9.20	3.63	9.20	3.81
110	15	14	18.50	3.91	17.30	3.61	16.10	3.31	15.00	3.05	13.80	2.78
	13	12	18.50	4.05	17.30	3.74	16.10	3.45	15.00	3.16	13.80	2.88
	11	10	18.50	4.23	17.30	3.90	16.10	3.59	15.00	3.28	13.80	2.99
	9	8	18.50	4.40	17.30	4.06	16.10	3.73	15.00	3.41	13.80	3.10
	7	6	18.10	4.51	17.30	4.29	16.10	3.94	15.00	3.60	13.80	3.27
	5	4	17.50	4.49	17.30	4.53	16.10	4.15	15.00	3.79	13.80	3.45
	3	2	16.90	4.43	16.80	4.53	16.10	4.34	15.00	3.98	13.80	3.60
	0	-1	15.80	4.32	15.80	4.42	15.80	4.52	15.00	4.27	13.80	3.87
	-3	-4	14.80	4.20	14.80	4.30	14.80	4.41	14.70	4.52	13.80	4.19
	-5	-6	14.20	4.34	14.20	4.46	14.10	4.57	14.10	4.69	13.80	4.67
	-7	-8	13.60	4.23	13.50	4.36	13.50	4.48	13.50	4.60	13.40	4.73
	-10	-11	12.30	4.21	12.30	4.34	12.30	4.48	12.20	4.63	12.20	4.75
	-12	-13	11.70	4.07	11.60	4.21	11.60	4.35	11.60	4.50	11.60	4.65
	-15	-16	11.00	3.91	11.00	4.07	11.00	4.22	10.90	4.37	10.90	4.52
	-17	-18	10.40	3.64	10.30	3.78	10.30	3.94	10.30	4.10	10.20	4.26
	-20	-21	9.30	3.35	9.20	3.51	9.20	3.68	9.20	3.85	9.10	4.01
100	15	14	16.60	3.34	15.50	3.10	14.20	2.84	13.50	2.61	12.30	2.38
	13	12	16.60	3.46	15.50	3.20	14.20	2.95	13.50	2.70	12.30	2.47
	11	10	16.60	3.61	15.50	3.34	14.20	3.07	13.50	2.81	12.30	2.57
	9	8	16.60	3.76	15.50	3.47	14.20	3.18	13.50	2.92	12.30	2.65
	7	6	16.60	3.95	15.50	3.65	14.00	3.40	13.50	3.07	12.30	2.79
	5	4	16.60	4.18	15.50	3.86	14.00	3.54	13.50	3.24	12.30	2.94
	3	2	16.60	4.38	15.50	4.03	14.00	3.70	13.50	3.38	12.30	3.07
	0	-1	15.80	4.35	15.50	4.34	14.00	3.97	13.50	3.64	12.30	3.29
	-3	-4	14.80	4.25	14.80	4.33	14.00	4.31	13.50	3.94	12.30	3.56
	-5	-6	14.20	4.39	14.10	4.49	13.80	4.60	13.50	4.38	12.30	3.96
	-7	-8	13.50	4.30	13.50	4.41	13.10	4.51	13.40	4.62	12.30	4.20
	-10	-11	12.30	4.30	12.30	4.41	12.10	4.54	12.20	4.66	12.20	4.79
	-12	-13	11.60	4.17	11.60	4.29	11.50	4.42	11.50	4.55	11.50	4.68
	-15	-16	11.00	4.03	10.90	4.16	10.80	4.30	10.90	4.43	10.90	4.57
	-17	-18	10.30	3.76	10.30	3.90	10.10	4.03	10.20	4.16	10.20	4.31
	-20	-21	9.20	3.51	9.20	3.65	9.20	3.81	9.10	3.94	9.10	4.10
90	15	14	14.80	2.99	13.80	2.77	12.80	2.56	11.90	2.35	10.90	2.14
	13	12	14.80	3.10	13.80	2.87	12.80	2.64	11.90	2.43	10.90	2.22
	11	10	14.80	3.23	13.80	2.99	12.80	2.75	11.90	2.52	10.90	2.30
	9	8	14.80	3.35	13.80	3.09	12.80	2.85	11.90	2.62	10.90	2.38
	7	6	14.80	3.53	13.80	3.27	12.80	3.00	11.90	2.75	10.90	2.50
	5	4	14.80	3.73	13.80	3.44	12.80	3.16	11.90	2.90	10.90	2.63
	3	2	14.80	3.89	13.80	3.59	12.80	3.30	11.90	3.02	10.90	2.74
	0	-1	14.80	4.18	13.80	3.86	12.80	3.54	11.90	3.23	10.90	2.93
	-3	-4	14.70	4.54	13.80	4.18	12.80	3.83	11.90	3.50	10.90	3.17
	-5	-6	14.10	4.71	13.80	4.67	12.80	4.26	11.90	3.89	10.90	3.52
	-7	-8	13.50	4.63	13.40	4.73	12.80	4.54	11.90	4.12	10.90	3.72
	-10	-11	12.20	4.65	12.20	4.75	12.20	4.86	11.90	4.79	10.90	4.32
	-12	-13	11.60	4.52	11.60	4.65	11.50	4.77	11.50	4.89	10.90	4.64
	-15	-16	10.90	4.40	10.90	4.52	10.90	4.65	10.80	4.78	10.80	4.90
	-17	-18	10.30	4.13	10.20	4.26	10.20	4.37	10.20	4.50	10.20	4.63
	-20	-21	9.20	3.88	9.10	4.01	9.10	4.15	9.10	4.29	9.10	4.43

10. Capacity Table

Combination, % (Capacity index)	Outdoor temperature (°C, DB)		Indoor temperature (°C, DB)									
			16		18		20		22		24	
	DB	WB	TC	PI	TC	PI	TC	PI	TC	PI	TC	PI
80	15	14	12.80	2.57	12.00	2.38	11.20	2.20	10.40	2.02	9.50	1.84
	13	12	12.80	2.65	12.00	2.46	11.20	2.27	10.40	2.09	9.50	1.91
	11	10	12.80	2.76	12.00	2.56	11.20	2.36	10.40	2.16	9.50	1.98
	9	8	12.80	2.86	12.00	2.65	11.20	2.45	10.40	2.24	9.50	2.05
	7	6	12.80	3.01	12.00	2.79	11.20	2.57	10.40	2.35	9.50	2.15
	5	4	12.80	3.18	12.00	2.94	11.20	2.70	10.40	2.47	9.50	2.25
	3	2	12.80	3.32	12.00	3.06	11.20	2.82	10.40	2.59	9.50	2.35
	0	-1	12.80	3.55	12.00	3.29	11.20	3.02	10.40	2.75	9.50	2.50
	-3	-4	12.80	3.84	12.00	3.55	11.20	3.26	10.40	2.97	9.50	2.70
	-5	-6	12.80	4.28	12.00	3.95	11.20	3.62	10.40	3.30	9.50	2.99
	-7	-8	12.80	4.55	12.00	4.19	11.20	3.83	10.40	3.49	9.50	3.17
	-10	-11	12.20	4.86	12.00	4.87	11.20	4.45	10.40	4.06	9.50	3.66
	-12	-13	11.50	4.76	11.50	4.86	11.20	4.77	10.40	4.34	9.50	3.91
	-15	-16	10.90	4.65	10.80	4.75	10.80	4.86	10.40	4.67	9.50	4.21
	-17	-18	10.20	4.36	10.20	4.48	10.20	4.60	10.10	4.71	9.50	4.40
	-20	-21	9.10	4.15	9.10	4.27	9.10	4.39	9.10	4.52	9.00	4.65
	15	14	11.00	2.16	10.30	2.01	9.50	1.85	8.80	1.70	8.10	1.56
	13	12	11.00	2.24	10.30	2.07	9.50	1.92	8.80	1.77	8.10	1.61
	11	10	11.00	2.32	10.30	2.15	9.50	1.99	8.80	1.82	8.10	1.66
	9	8	11.00	2.41	10.30	2.24	9.50	2.06	8.80	1.89	8.10	1.72
7	6	11.00	2.52	10.30	2.33	9.50	2.16	8.80	1.98	8.10	1.80	
5	4	11.00	2.66	10.30	2.46	9.50	2.26	8.80	2.07	8.10	1.89	
3	2	11.00	2.77	10.30	2.56	9.50	2.36	8.80	2.16	8.10	1.96	
0	-1	11.00	2.96	10.30	2.74	9.50	2.52	8.80	2.30	8.10	2.10	
-3	-4	11.00	3.20	10.30	2.96	9.50	2.71	8.80	2.47	8.10	2.25	
-5	-6	11.00	3.55	10.30	3.28	9.50	3.01	8.80	2.75	8.10	2.49	
-7	-8	11.00	3.77	10.30	3.47	9.50	3.18	8.80	2.90	8.10	2.62	
-10	-11	11.00	4.37	10.30	4.02	9.50	3.68	8.80	3.34	8.10	3.03	
-12	-13	11.00	4.69	10.30	4.30	9.50	3.93	8.80	3.57	8.10	3.23	
-15	-16	10.80	4.89	10.30	4.64	9.50	4.23	8.80	3.84	8.10	3.47	
-17	-18	10.20	4.62	10.10	4.72	9.50	4.42	8.80	4.02	8.10	3.61	
-20	-21	9.10	4.41	9.10	4.53	9.00	4.64	8.80	4.56	8.10	4.10	
15	14	9.10	1.78	8.50	1.65	7.90	1.53	7.30	1.41	6.60	1.29	
13	12	9.10	1.83	8.50	1.70	7.90	1.57	7.30	1.44	6.60	1.31	
11	10	9.10	1.90	8.50	1.77	7.90	1.63	7.30	1.50	6.60	1.36	
9	8	9.10	1.97	8.50	1.82	7.90	1.69	7.30	1.54	6.60	1.41	
7	6	9.10	2.05	8.50	1.92	7.90	1.77	7.30	1.62	6.60	1.48	
5	4	9.10	2.17	8.50	2.01	7.90	1.85	7.30	1.69	6.60	1.54	
3	2	9.10	2.26	8.50	2.09	7.90	1.92	7.30	1.77	6.60	1.60	
0	-1	9.10	2.41	8.50	2.23	7.90	2.05	7.30	1.87	6.60	1.70	
-3	-4	9.10	2.59	8.50	2.39	7.90	2.20	7.30	2.01	6.60	1.82	
-5	-6	9.10	2.87	8.50	2.65	7.90	2.43	7.30	2.23	6.60	2.01	
-7	-8	9.10	3.03	8.50	2.80	7.90	2.57	7.30	2.34	6.60	2.12	
-10	-11	9.10	3.51	8.50	3.23	7.90	2.96	7.30	2.69	6.60	2.43	
-12	-13	9.10	3.75	8.50	3.45	7.90	3.15	7.30	2.88	6.60	2.59	
-15	-16	9.10	4.02	8.50	3.70	7.90	3.38	7.30	3.07	6.60	2.76	
-17	-18	9.10	4.22	8.50	3.87	7.90	3.52	7.30	3.20	6.60	2.87	
-20	-21	9.00	4.70	8.50	4.38	7.90	4.00	7.30	3.61	6.60	3.24	
15	14	7.30	1.42	6.80	1.31	6.20	1.20	5.70	1.11	5.20	1.01	
13	12	7.30	1.45	6.80	1.35	6.20	1.25	5.70	1.14	5.20	1.04	
11	10	7.30	1.50	6.80	1.40	6.20	1.29	5.70	1.18	5.20	1.08	
9	8	7.30	1.55	6.80	1.44	6.20	1.32	5.70	1.22	5.20	1.11	
7	6	7.30	1.63	6.80	1.51	6.20	1.38	5.70	1.27	5.20	1.16	
5	4	7.30	1.70	6.80	1.58	6.20	1.45	5.70	1.34	5.20	1.21	
3	2	7.30	1.77	6.80	1.65	6.20	1.51	5.70	1.38	5.20	1.26	
0	-1	7.30	1.88	6.80	1.75	6.20	1.60	5.70	1.46	5.20	1.33	
-3	-4	7.30	2.02	6.80	1.87	6.20	1.71	5.70	1.57	5.20	1.42	
-5	-6	7.30	2.24	6.80	2.07	6.20	1.89	5.70	1.72	5.20	1.57	
-7	-8	7.30	2.35	6.80	2.18	6.20	1.99	5.70	1.81	5.20	1.63	
-10	-11	7.30	2.71	6.80	2.50	6.20	2.28	5.70	2.07	5.20	1.87	
-12	-13	7.30	2.89	6.80	2.65	6.20	2.43	5.70	2.20	5.20	1.99	
-15	-16	7.30	3.09	6.80	2.83	6.20	2.58	5.70	2.35	5.20	2.12	
-17	-18	7.30	3.22	6.80	2.95	6.20	2.70	5.70	2.44	5.20	2.20	
-20	-21	7.30	3.64	6.80	3.34	6.20	3.03	5.70	2.74	5.20	2.46	

NOTE

- Capacity table may be subject to change without prior notice.
- Capacity table comply with EN14511.
- Cooling capacities are based on;
 - Indoor temperature : 27°C DB, 19°C WB
 - Outdoor temperature : 35°C DB, 24°C WB, Equivalent refrigerant piping : 7.5m, Level differences : 0m
- Heating capacities are based on;
 - Indoor temperature : 20°C DB, 15°C WB
 - Outdoor temperature : 7°C DB, 6°C WB, Equivalent refrigerant piping : 7.5m, Level differences : 0m

10. Capacity Table

AM040FXMDEH/EU

Cooling

TC : Total Capacity, PI : Power Input

Combination, % (Capacity index)	Outdoor temperature (°C, DB)	Indoor temperature (°C, WB)													
		14		16		18		19		20		22		24	
		TC kW	PI kW	TC kW	PI kW	TC kW	PI kW	TC kW	PI kW	TC kW	PI kW	TC kW	PI kW	TC kW	PI kW
130	10	10.80	1.32	12.80	1.62	14.90	1.92	16.00	2.07	16.80	2.18	17.20	2.09	17.50	1.99
	12	10.80	1.34	12.80	1.64	14.90	1.96	15.90	2.11	16.60	2.17	16.90	2.07	17.40	2.03
	14	10.80	1.37	12.80	1.68	14.90	1.99	15.90	2.15	16.30	2.15	16.70	2.14	17.10	2.15
	16	10.80	1.40	12.80	1.71	14.90	2.03	15.90	2.22	16.10	2.23	16.40	2.25	16.90	2.27
	18	10.80	1.42	12.80	1.74	14.90	2.17	15.60	2.33	15.80	2.34	16.20	2.36	16.60	2.38
	20	10.70	1.45	12.70	1.86	14.80	2.33	15.50	2.45	15.60	2.46	16.00	2.47	16.40	2.51
	21	10.70	1.49	12.70	1.92	14.80	2.42	15.30	2.51	15.50	2.52	15.90	2.54	16.30	2.56
	23	10.70	1.59	12.70	2.06	14.80	2.59	15.10	2.62	15.20	2.63	15.70	2.65	16.00	2.68
	25	10.70	1.71	12.70	2.21	14.60	2.72	14.90	2.73	15.10	2.75	15.40	2.77	15.80	2.80
	27	10.70	1.83	12.70	2.36	14.40	2.84	14.60	2.84	14.80	2.86	15.20	2.89	15.60	2.91
	29	10.70	1.95	12.70	2.52	14.20	2.94	14.40	2.96	14.60	2.98	14.90	3.01	15.40	3.03
	31	10.70	2.07	12.70	2.70	14.00	3.06	14.10	3.08	14.30	3.09	14.80	3.12	15.10	3.16
	33	10.70	2.21	12.70	2.88	13.70	3.18	14.00	3.20	14.10	3.21	14.50	3.24	14.90	3.27
	35	10.60	2.36	12.60	3.07	13.50	3.30	13.70	3.31	13.80	3.33	14.30	3.36	14.60	3.40
	37	10.30	2.51	12.20	3.27	12.80	3.41	13.10	3.43	13.20	3.45	13.60	3.49	14.00	3.52
	39	10.10	2.67	12.00	3.49	12.40	3.53	12.60	3.54	12.70	3.57	13.10	3.60	13.50	3.64
	42	10.10	2.84	12.00	3.71	12.20	3.65	12.30	3.66	12.50	3.68	13.00	3.72	13.20	3.76
	44	10.10	2.99	12.00	3.92	12.10	3.77	12.10	3.77	12.20	3.81	12.80	3.85	13.00	3.88
	46	10.10	3.16	12.00	4.14	11.90	3.90	11.80	3.89	12.00	3.93	12.60	3.97	12.70	4.00
	120	10	9.90	1.21	11.80	1.47	13.80	1.75	14.70	1.89	15.70	2.03	16.90	2.15	17.30
12		9.90	1.23	11.80	1.50	13.80	1.78	14.70	1.92	15.70	2.07	16.70	2.14	17.00	2.05
14		9.90	1.25	11.80	1.53	13.70	1.82	14.70	1.96	15.70	2.11	16.50	2.13	16.80	2.14
16		9.90	1.27	11.80	1.55	13.70	1.85	14.70	2.01	15.70	2.17	16.20	2.24	16.50	2.25
18		9.90	1.30	11.80	1.59	13.70	1.92	14.70	2.12	15.60	2.33	16.00	2.35	16.30	2.37
20		9.90	1.32	11.80	1.65	13.70	2.06	14.70	2.29	15.40	2.44	15.70	2.47	16.10	2.48
21		9.90	1.34	11.80	1.71	13.70	2.14	14.60	2.37	15.30	2.51	15.60	2.52	16.00	2.54
23		9.80	1.43	11.80	1.83	13.70	2.29	14.60	2.54	15.00	2.62	15.40	2.64	15.80	2.66
25		9.80	1.52	11.70	1.96	13.70	2.46	14.60	2.72	14.80	2.73	15.10	2.75	15.50	2.78
27		9.80	1.63	11.70	2.10	13.60	2.62	14.30	2.84	14.50	2.84	15.00	2.87	15.30	2.89
29		9.80	1.74	11.70	2.25	13.60	2.80	14.20	2.94	14.30	2.96	14.70	2.98	15.00	3.02
31		9.80	1.85	11.70	2.39	13.60	3.00	13.90	3.06	14.10	3.07	14.50	3.10	14.80	3.13
33		9.80	1.97	11.70	2.55	13.50	3.16	13.70	3.17	13.90	3.19	14.20	3.22	14.60	3.25
35		9.80	2.10	11.70	2.72	13.20	3.27	13.40	3.29	13.70	3.31	14.00	3.34	14.30	3.37
37		9.50	2.24	11.30	2.90	12.70	3.39	12.80	3.41	13.00	3.42	13.30	3.46	13.70	3.49
39		9.30	2.38	11.10	3.09	12.20	3.51	12.40	3.53	12.60	3.54	12.90	3.58	13.20	3.61
42		9.30	2.52	11.10	3.27	11.90	3.63	12.20	3.64	12.40	3.67	12.70	3.70	13.10	3.73
44		9.30	2.66	11.10	3.46	11.70	3.75	12.10	3.75	12.20	3.79	12.60	3.82	12.90	3.86
46		9.30	2.80	11.10	3.65	11.40	3.87	11.90	3.86	12.10	3.90	12.40	3.94	12.70	3.97
110		10	9.10	1.09	10.90	1.34	12.60	1.59	13.50	1.71	14.40	1.84	16.10	2.10	16.90
	12	9.10	1.12	10.90	1.36	12.60	1.61	13.50	1.74	14.40	1.88	16.10	2.14	16.70	2.13
	14	9.10	1.13	10.90	1.38	12.60	1.64	13.50	1.78	14.40	1.92	16.10	2.18	16.50	2.13
	16	9.10	1.15	10.80	1.41	12.60	1.68	13.50	1.81	14.30	1.95	15.90	2.22	16.30	2.25
	18	9.10	1.18	10.80	1.44	12.60	1.71	13.50	1.86	14.30	2.05	15.70	2.33	16.00	2.36
	20	9.10	1.20	10.80	1.47	12.60	1.81	13.40	2.00	14.30	2.20	15.50	2.45	15.80	2.47
	21	9.10	1.22	10.80	1.51	12.60	1.87	13.40	2.07	14.30	2.29	15.30	2.51	15.70	2.52
	23	9.10	1.27	10.80	1.62	12.50	2.01	13.40	2.22	14.30	2.45	15.10	2.62	15.40	2.64
	25	9.00	1.36	10.80	1.74	12.50	2.15	13.40	2.38	14.30	2.62	14.90	2.73	15.20	2.76
	27	9.00	1.45	10.80	1.85	12.50	2.30	13.40	2.55	14.30	2.80	14.60	2.85	15.00	2.87
	29	9.00	1.55	10.80	1.97	12.50	2.47	13.40	2.73	14.10	2.94	14.40	2.97	14.80	2.98
	31	9.00	1.64	10.80	2.10	12.50	2.62	13.40	2.91	13.90	3.05	14.10	3.08	14.50	3.11
	33	9.00	1.74	10.80	2.25	12.50	2.80	13.40	3.11	13.60	3.16	14.00	3.20	14.30	3.22
	35	9.00	1.86	10.70	2.39	12.40	2.99	13.20	3.27	13.40	3.29	13.70	3.31	14.00	3.35
	37	8.70	1.97	10.40	2.54	12.10	3.19	12.60	3.39	12.70	3.40	13.10	3.43	13.40	3.46
	39	8.50	2.10	10.20	2.71	11.80	3.40	12.20	3.50	12.30	3.52	12.60	3.55	12.90	3.58
	42	8.50	2.23	10.20	2.88	11.80	3.60	12.00	3.62	12.20	3.63	12.50	3.68	12.60	3.69
	44	8.50	2.36	10.20	3.05	11.80	3.82	11.80	3.73	12.00	3.75	12.30	3.79	12.40	3.81
	46	8.50	2.48	10.20	3.21	11.80	4.02	11.70	3.85	11.80	3.86	12.20	3.91	12.20	3.92
	100	10	8.30	0.99	9.90	1.19	11.50	1.41	12.30	1.53	13.10	1.65	14.60	1.88	16.30
12		8.30	1.01	9.90	1.23	11.50	1.45	12.30	1.56	13.10	1.68	14.60	1.92	16.30	2.16
14		8.30	1.02	9.90	1.24	11.50	1.47	12.30	1.59	13.00	1.71	14.60	1.96	16.20	2.19
16		8.30	1.04	9.90	1.27	11.50	1.50	12.20	1.63	13.00	1.74	14.60	1.99	15.90	2.22
18		8.30	1.06	9.90	1.29	11.40	1.53	12.20	1.66	13.00	1.78	14.60	2.10	15.70	2.33
20		8.20	1.08	9.90	1.32	11.40	1.58	12.20	1.74	13.00	1.91	14.60	2.27	15.50	2.45
21		8.20	1.09	9.90	1.33	11.40	1.63	12.20	1.80	13.00	1.97	14.60	2.35	15.30	2.51
23		8.20	1.12	9.80	1.41	11.40	1.75	12.20	1.92	13.00	2.12	14.50	2.52	15.20	2.62
25		8.20	1.19	9.80	1.52	11.40	1.87	12.20	2.07	13.00	2.27	14.50	2.70	14.90	2.74
27		8.20	1.27	9.80	1.62	11.40	2.00	12.20	2.21	13.00	2.43	14.30	2.84	14.70	2.85
29		8.20	1.36	9.80	1.73	11.40	2.14	12.20	2.36	12.90	2.59	14.20	2.94	14.40	2.97
31		8.20	1.45	9.80	1.84	11.40	2.29	12.20	2.52	12.90	2.77	13.90	3.06	14.20	3.08
33		8.20	1.54	9.80	1.96	11.40	2.43	12.10	2.69	12.90	2.96	13.70	3.17	14.00	3.20
35		8.20	1.63	9.80	2.08	11.30	2.59	12.10	2.89	12.90	3.16	13.40	3.29	13.70	3.31
37		7.90	1.74	9.50	2.21	11.00	2.76	11.70	3.05	12.50	3.36	12.80	3.41	13.10	3.44
39		7.80	1.84	9.30	2.36	10.80	2.94	11.50	3.26	12.10	3.49	12.30	3.53	12.60	3.55
42		7.80	1.95	9.30	2.50	10.80	3.12	11.50	3.46	11.90	3.63	12.10	3.64	12.50	3.67
44		7.80	2.06	9.30	2.64	10.80	3.31	11.50	3.66	11.70	3.77	11.80	3.75	12.30	3.78
46		7.80	2.16	9.30	2.78	10.80	3.49	11.50	3.86	11.60	3.90	11.60	3.86	12.20	3.90
90		10	7.50	0.89	8.90	1.07	10.40	1.26	11.10	1.36	11.80	1.46	13.20	1.66	14.60
	12	7.50	0.90	8.90	1.08	10.30	1.28	11.00	1.38	11.70	1.49	13.20	1.70	14.60	1.92
	14	7.40	0.91	8.80	1.11	10.30	1.31	11.00	1.41	11.70	1.52	13.20	1.74	14.60	1.96
	16	7.40	0.93	8.80	1.13	10.30	1.33	11.00	1.44	11.70	1.55	13.20	1.77	14.60	1.99
	18	7.40	0.95	8.80	1.15	10.30	1.36	11.00	1.46	11.70	1.58	13.20	1.80	14.60	2.10
	20	7.40	0.97	8.80	1.17	10.30	1.38	11.00	1.50	11.70	1.64	13.20	1.93	14.60	2.26

10. Capacity Table

Cooling

TC : Total Capacity, PI : Power Input

Combination, % (Capacity index)	Outdoor temperature (°C, DB)	Indoor temperature (°C, WB)													
		14		16		18		19		20		22		24	
		TC kW	PI kW	TC kW	PI kW	TC kW	PI kW	TC kW	PI kW	TC kW	PI kW	TC kW	PI kW	TC kW	PI kW
90	37	7.10	1.50	8.50	1.92	9.90	2.36	10.60	2.62	11.20	2.87	12.60	3.38	12.80	3.41
	39	7.00	1.59	8.30	2.03	9.70	2.52	10.30	2.78	11.00	3.05	12.10	3.49	12.30	3.53
	42	7.00	1.69	8.30	2.14	9.70	2.67	10.30	2.94	11.00	3.24	11.80	3.61	12.10	3.64
	44	7.00	1.78	8.30	2.25	9.70	2.83	10.30	3.12	11.00	3.43	11.60	3.72	11.80	3.75
	46	7.00	1.88	8.30	2.37	9.70	2.98	10.30	3.28	11.00	3.62	11.30	3.84	11.60	3.86
80	10	6.60	0.79	7.90	0.94	9.20	1.10	9.80	1.19	10.40	1.27	11.80	1.45	13.00	1.64
	12	6.60	0.80	7.90	0.95	9.20	1.12	9.80	1.21	10.40	1.30	11.70	1.48	13.00	1.67
	14	6.60	0.81	7.90	0.97	9.20	1.15	9.80	1.23	10.40	1.32	11.70	1.51	13.00	1.70
	16	6.60	0.82	7.90	1.00	9.20	1.17	9.80	1.26	10.40	1.35	11.70	1.55	12.90	1.74
	18	6.60	0.84	7.90	1.01	9.20	1.19	9.80	1.28	10.40	1.37	11.70	1.57	12.90	1.77
	20	6.60	0.86	7.90	1.03	9.20	1.21	9.80	1.31	10.40	1.41	11.70	1.63	12.90	1.89
	21	6.60	0.86	7.90	1.04	9.20	1.23	9.80	1.32	10.40	1.43	11.70	1.69	12.90	1.96
	23	6.60	0.88	7.90	1.05	9.10	1.28	9.80	1.41	10.40	1.53	11.70	1.81	12.90	2.10
	25	6.60	0.90	7.80	1.13	9.10	1.37	9.70	1.50	10.40	1.64	11.70	1.93	12.90	2.25
	27	6.60	0.96	7.80	1.20	9.10	1.46	9.70	1.60	10.30	1.75	11.70	2.07	12.90	2.41
	29	6.60	1.02	7.80	1.27	9.10	1.55	9.70	1.71	10.30	1.87	11.60	2.21	12.90	2.58
	31	6.60	1.08	7.80	1.36	9.10	1.66	9.70	1.82	10.30	1.99	11.60	2.36	12.80	2.75
	33	6.60	1.15	7.80	1.45	9.10	1.77	9.70	1.94	10.30	2.12	11.60	2.51	12.80	2.94
	35	6.50	1.23	7.80	1.53	9.10	1.88	9.70	2.07	10.30	2.26	11.60	2.68	12.80	3.13
	37	6.30	1.30	7.60	1.63	8.80	2.00	9.40	2.20	10.00	2.40	11.20	2.85	12.40	3.35
39	6.20	1.37	7.40	1.73	8.60	2.12	9.20	2.33	9.80	2.57	11.00	3.04	12.10	3.49	
42	6.20	1.45	7.40	1.83	8.60	2.25	9.20	2.47	9.80	2.73	11.00	3.23	12.00	3.65	
44	6.20	1.54	7.40	1.92	8.60	2.36	9.20	2.62	9.80	2.89	11.00	3.42	11.90	3.81	
46	6.20	1.62	7.40	2.03	8.60	2.48	9.20	2.76	9.80	3.05	11.00	3.60	11.80	3.96	
70	10	5.80	0.69	6.90	0.82	8.00	0.95	8.60	1.03	9.10	1.10	10.30	1.25	11.40	1.41
	12	5.80	0.70	6.90	0.83	8.00	0.97	8.60	1.04	9.10	1.12	10.30	1.27	11.40	1.43
	14	5.80	0.71	6.90	0.85	8.00	0.99	8.60	1.07	9.10	1.14	10.20	1.30	11.40	1.45
	16	5.80	0.72	6.90	0.86	8.00	1.01	8.60	1.08	9.10	1.16	10.20	1.32	11.40	1.49
	18	5.80	0.73	6.90	0.88	8.00	1.03	8.60	1.10	9.10	1.18	10.20	1.35	11.40	1.52
	20	5.80	0.75	6.90	0.90	8.00	1.04	8.60	1.13	9.10	1.21	10.20	1.37	11.30	1.55
	21	5.80	0.75	6.90	0.90	8.00	1.05	8.50	1.13	9.10	1.23	10.20	1.40	11.30	1.62
	23	5.80	0.76	6.90	0.92	8.00	1.08	8.50	1.18	9.10	1.27	10.20	1.50	11.30	1.74
	25	5.80	0.78	6.90	0.95	8.00	1.15	8.50	1.26	9.00	1.37	10.20	1.59	11.30	1.85
	27	5.70	0.82	6.90	1.01	8.00	1.23	8.50	1.34	9.00	1.45	10.20	1.70	11.30	1.98
	29	5.70	0.87	6.90	1.08	8.00	1.30	8.50	1.42	9.00	1.55	10.20	1.82	11.30	2.11
	31	5.70	0.93	6.80	1.15	8.00	1.39	8.50	1.52	9.00	1.65	10.20	1.94	11.30	2.25
	33	5.70	0.99	6.80	1.22	7.90	1.48	8.50	1.61	9.00	1.76	10.10	2.07	11.30	2.40
	35	5.70	1.04	6.80	1.29	7.90	1.56	8.50	1.71	9.00	1.87	10.10	2.20	11.20	2.56
	37	5.50	1.10	6.60	1.37	7.70	1.66	8.20	1.82	8.70	1.99	9.80	2.34	10.90	2.73
39	5.40	1.17	6.50	1.45	7.50	1.77	8.00	1.93	8.50	2.11	9.60	2.49	10.70	2.91	
42	5.40	1.23	6.50	1.53	7.50	1.87	8.00	2.05	8.50	2.25	9.60	2.64	10.70	3.09	
44	5.40	1.30	6.50	1.61	7.50	1.96	8.00	2.16	8.50	2.37	9.60	2.79	10.70	3.27	
46	5.40	1.37	6.50	1.69	7.50	2.07	8.00	2.28	8.50	2.50	9.60	2.94	10.70	3.45	
60	10	5.00	0.60	5.90	0.71	6.90	0.81	7.40	0.87	7.80	0.93	8.80	1.05	9.70	1.18
	12	5.00	0.61	5.90	0.71	6.90	0.82	7.40	0.89	7.80	0.95	8.80	1.08	9.70	1.20
	14	5.00	0.62	5.90	0.72	6.90	0.85	7.40	0.90	7.80	0.97	8.80	1.09	9.70	1.23
	16	5.00	0.62	5.90	0.74	6.90	0.86	7.30	0.92	7.80	0.98	8.70	1.12	9.70	1.25
	18	5.00	0.64	5.90	0.75	6.90	0.87	7.30	0.93	7.80	1.00	8.70	1.13	9.70	1.27
	20	5.00	0.64	5.90	0.76	6.90	0.89	7.30	0.95	7.80	1.02	8.70	1.15	9.70	1.30
	21	4.90	0.65	5.90	0.77	6.80	0.90	7.30	0.96	7.80	1.03	8.70	1.17	9.70	1.31
	23	4.90	0.67	5.90	0.79	6.80	0.91	7.30	0.98	7.80	1.04	8.70	1.22	9.70	1.40
	25	4.90	0.67	5.90	0.80	6.80	0.95	7.30	1.03	7.80	1.12	8.70	1.30	9.70	1.49
	27	4.90	0.70	5.90	0.85	6.80	1.01	7.30	1.09	7.80	1.19	8.70	1.38	9.70	1.59
	29	4.90	0.74	5.90	0.90	6.80	1.08	7.30	1.17	7.80	1.26	8.70	1.47	9.60	1.69
	31	4.90	0.79	5.90	0.95	6.80	1.14	7.30	1.24	7.80	1.34	8.70	1.56	9.60	1.81
	33	4.90	0.82	5.90	1.01	6.80	1.21	7.30	1.32	7.80	1.43	8.70	1.66	9.60	1.92
	35	4.90	0.87	5.80	1.07	6.80	1.28	7.30	1.40	7.70	1.52	8.60	1.77	9.60	2.05
	37	4.80	0.93	5.70	1.13	6.60	1.37	7.00	1.48	7.50	1.61	8.40	1.88	9.30	2.18
39	4.70	0.98	5.50	1.19	6.40	1.45	6.90	1.57	7.30	1.71	8.20	2.00	9.10	2.32	
42	4.70	1.04	5.50	1.26	6.40	1.52	6.90	1.66	7.30	1.81	8.20	2.11	9.10	2.46	
44	4.70	1.08	5.50	1.32	6.40	1.60	6.90	1.74	7.30	1.92	8.20	2.23	9.10	2.60	
46	4.70	1.14	5.50	1.37	6.40	1.69	6.90	1.83	7.30	2.01	8.20	2.34	9.10	2.74	
50	10	4.10	0.52	4.90	0.60	5.70	0.68	6.10	0.72	6.50	0.77	7.30	0.87	8.10	0.97
	12	4.10	0.53	4.90	0.60	5.70	0.69	6.10	0.74	6.50	0.79	7.30	0.89	8.10	0.99
	14	4.10	0.53	4.90	0.62	5.70	0.71	6.10	0.75	6.50	0.80	7.30	0.90	8.10	1.00
	16	4.10	0.53	4.90	0.62	5.70	0.71	6.10	0.76	6.50	0.81	7.30	0.91	8.10	1.02
	18	4.10	0.54	4.90	0.63	5.70	0.72	6.10	0.78	6.50	0.82	7.30	0.93	8.10	1.04
	20	4.10	0.55	4.90	0.64	5.70	0.74	6.10	0.79	6.50	0.84	7.30	0.95	8.10	1.06
	21	4.10	0.56	4.90	0.65	5.70	0.75	6.10	0.80	6.50	0.85	7.30	0.96	8.10	1.07
	23	4.10	0.57	4.90	0.66	5.70	0.76	6.10	0.81	6.50	0.86	7.30	0.97	8.10	1.09
	25	4.10	0.57	4.90	0.67	5.70	0.77	6.10	0.82	6.50	0.90	7.30	1.03	8.10	1.17
	27	4.10	0.58	4.90	0.69	5.70	0.81	6.10	0.88	6.50	0.95	7.30	1.08	8.10	1.24
	29	4.10	0.62	4.90	0.73	5.70	0.86	6.10	0.93	6.50	1.01	7.30	1.16	8.10	1.32
	31	4.10	0.65	4.90	0.78	5.70	0.92	6.10	1.00	6.50	1.07	7.30	1.23	8.10	1.41
	33	4.10	0.68	4.90	0.82	5.70	0.97	6.10	1.05	6.50	1.13	7.30	1.31	8.00	1.50
	35	4.10	0.72	4.90	0.87	5.70	1.03	6.10	1.12	6.40	1.20	7.20	1.39	8.00	1.59
	37	4.00	0.76	4.70	0.92	5.50	1.08	5.90	1.18	6.30	1.27	7.00	1.48	7.80	1.69
39	3.90	0.81	4.60	0.97	5.40	1.15	5.70	1.25	6.10	1.35	6.90	1.56	7.60	1.79	
42	3.90	0.85	4.60	1.03	5.40	1.23	5.70	1.32	6.10	1.42	6.90	1.65	7.60	1.89	
44	3.90	0.89	4.60	1.08	5.40	1.29	5.70	1.38	6.10	1.50	6.90	1.74	7.60	1.99	
46	3.90	0.93	4.60	1.13	5.40	1.36	5.70	1.45	6.10	1.57	6.90	1.83	7.60	2.10	

NOTE

- Capacity table may be subject to change without prior notice.
- Capacity table comply with EN14511.
- Cooling capacities are based on;
 - Indoor temperature : 27°C DB, 19°C WB
 - Outdoor temperature : 35°C DB, 24°C WB, Equivalent refrigerant piping : 7.5m, Level differences : 0m
- Heating capacities are based on;
 - Indoor temperature : 20°C DB, 15°C WB
 - Outdoor temperature : 7°C DB, 6°C WB, Equivalent refrigerant piping : 7.5m, Level differences : 0m

10. Capacity Table

Heating

TC : Total Capacity, PI : Power Input

Combination, % (Capacity index)	Outdoor temperature (°C)		Indoor temperature (°C, DB)									
			16		18		20		22		24	
	DB	WB	TC kW	PI kW	TC kW	PI kW	TC kW	PI kW	TC kW	PI kW	TC kW	PI kW
130	15	14	20.40	3.85	19.20	3.57	18.10	3.30	16.90	3.05	15.80	2.80
	13	12	20.40	3.99	19.20	3.70	18.10	3.42	16.90	3.16	15.80	2.90
	11	10	20.40	4.15	19.20	3.86	18.10	3.56	16.90	3.29	15.80	3.01
	9	8	20.40	4.33	19.20	4.01	18.10	3.70	16.90	3.41	15.80	3.13
	7	6	20.10	4.47	19.20	4.22	18.10	3.89	16.90	3.58	15.80	3.28
	5	4	19.60	4.47	19.20	4.45	18.10	4.11	16.90	3.78	15.80	3.45
	3	2	18.90	4.41	18.80	4.50	18.10	4.29	16.90	3.94	15.80	3.60
	0	-1	17.90	4.34	17.90	4.41	17.80	4.51	16.90	4.22	15.80	3.86
	-3	-4	16.90	4.23	16.80	4.33	16.80	4.41	16.80	4.51	15.80	4.16
	-5	-6	16.20	4.37	16.20	4.47	16.10	4.57	16.10	4.67	15.80	4.61
	-7	-8	15.60	4.28	15.50	4.39	15.50	4.50	15.50	4.61	15.50	4.69
	-10	-11	14.40	4.28	14.40	4.40	14.40	4.52	14.40	4.64	14.20	4.76
	-12	-13	13.70	4.17	13.70	4.30	13.70	4.42	13.60	4.54	13.60	4.67
	-15	-16	13.00	4.06	13.00	4.18	13.00	4.31	12.90	4.44	12.90	4.56
	-17	-18	12.30	3.81	12.30	3.95	12.20	4.08	12.20	4.22	12.20	4.35
	-20	-21	11.40	3.58	11.40	3.73	11.20	3.87	11.20	4.02	11.20	4.17
120	15	14	18.80	3.47	17.80	3.24	16.70	3.00	15.60	2.77	14.60	2.55
	13	12	18.80	3.60	17.80	3.35	16.70	3.11	15.60	2.87	14.60	2.63
	11	10	18.80	3.75	17.80	3.48	16.70	3.22	15.60	2.98	14.60	2.73
	9	8	18.80	3.89	17.80	3.62	16.70	3.35	15.60	3.08	14.60	2.83
	7	6	18.80	4.11	17.80	3.81	16.70	3.52	15.60	3.25	14.60	2.98
	5	4	18.80	4.34	17.80	4.01	16.70	3.71	15.60	3.41	14.60	3.13
	3	2	18.80	4.52	17.80	4.20	16.70	3.87	15.60	3.56	14.60	3.26
	0	-1	17.80	4.44	17.80	4.50	16.70	4.15	15.60	3.82	14.60	3.48
	-3	-4	16.80	4.35	16.80	4.43	16.70	4.49	15.60	4.11	14.60	3.75
	-5	-6	16.10	4.51	16.10	4.59	16.10	4.68	15.60	4.55	14.60	4.14
	-7	-8	15.50	4.42	15.50	4.53	15.50	4.63	15.50	4.71	14.60	4.39
	-10	-11	14.40	4.44	14.40	4.54	14.20	4.66	14.20	4.77	14.20	4.88
	-12	-13	13.70	4.34	13.70	4.45	13.60	4.56	13.60	4.68	13.60	4.80
	-15	-16	13.00	4.23	12.90	4.35	12.90	4.47	12.90	4.59	12.90	4.71
	-17	-18	12.30	3.99	12.20	4.12	12.20	4.24	12.20	4.36	12.20	4.49
	-20	-21	11.20	3.79	11.20	3.92	11.20	4.06	11.20	4.18	11.10	4.33
110	15	14	17.20	3.13	16.20	2.91	15.30	2.70	14.40	2.49	13.30	2.30
	13	12	17.20	3.24	16.20	3.01	15.30	2.79	14.40	2.58	13.30	2.37
	11	10	17.20	3.37	16.20	3.13	15.30	2.90	14.40	2.69	13.30	2.46
	9	8	17.20	3.49	16.20	3.25	15.30	3.01	14.40	2.78	13.30	2.56
	7	6	17.20	3.68	16.20	3.42	15.30	3.16	14.40	2.92	13.30	2.67
	5	4	17.20	3.87	16.20	3.59	15.30	3.32	14.40	3.07	13.30	2.82
	3	2	17.20	4.03	16.20	3.75	15.30	3.47	14.40	3.20	13.30	2.92
	0	-1	17.20	4.34	16.20	4.02	15.30	3.72	14.40	3.42	13.30	3.13
	-3	-4	16.80	4.48	16.20	4.35	15.30	4.01	14.40	3.69	13.30	3.38
	-5	-6	16.10	4.64	16.10	4.71	15.30	4.43	14.40	4.07	13.30	3.72
	-7	-8	15.50	4.57	15.50	4.66	15.30	4.68	14.40	4.30	13.30	3.94
	-10	-11	14.40	4.61	14.20	4.70	14.20	4.80	14.20	4.90	13.30	4.51
	-12	-13	13.60	4.51	13.60	4.62	13.60	4.71	13.60	4.82	13.30	4.81
	-15	-16	12.90	4.40	12.90	4.51	12.90	4.63	12.90	4.73	12.80	4.84
	-17	-18	12.20	4.17	12.20	4.28	12.20	4.40	12.20	4.51	12.10	4.63
	-20	-21	11.20	3.98	11.20	4.10	11.20	4.23	11.10	4.35	11.10	4.48
100	15	14	15.70	2.63	14.80	2.46	13.80	2.29	13.00	2.11	12.10	1.96
	13	12	15.70	2.73	14.80	2.55	13.80	2.42	13.00	2.19	12.10	2.03
	11	10	15.70	2.84	14.80	2.64	13.80	2.67	13.00	2.27	12.10	2.09
	9	8	15.70	2.94	14.80	2.74	13.80	2.86	13.00	2.35	12.10	2.17
	7	6	15.70	3.10	14.80	2.88	13.50	3.02	13.00	2.47	12.10	2.28
	5	4	15.70	3.25	14.80	3.02	13.50	3.17	13.00	2.59	12.10	2.38
	3	2	15.70	3.40	14.80	3.16	13.50	3.25	13.00	2.70	12.10	2.48
	0	-1	15.70	3.63	14.80	3.38	13.50	3.37	13.00	2.88	12.10	2.65
	-3	-4	15.70	3.92	14.80	3.65	13.50	3.49	13.00	3.10	12.10	2.84
	-5	-6	15.70	4.34	14.80	4.01	13.50	3.71	13.00	3.41	12.10	3.13
	-7	-8	15.50	4.45	14.80	4.26	13.50	3.93	13.00	3.60	12.10	3.30
	-10	-11	14.20	4.50	14.20	4.58	13.50	4.51	13.00	4.14	12.10	3.79
	-12	-13	13.60	4.43	13.60	4.51	13.30	4.61	13.00	4.42	12.10	4.03
	-15	-16	12.90	4.34	12.90	4.43	12.90	4.52	12.80	4.62	12.10	4.31
	-17	-18	12.20	4.12	12.20	4.22	12.10	4.31	12.10	4.41	12.10	4.50
	-20	-21	11.20	3.95	11.10	4.07	11.10	4.16	11.10	4.28	11.10	4.38
90	15	14	14.10	2.46	13.30	2.30	12.60	2.14	11.70	1.98	10.90	1.84
	13	12	14.10	2.55	13.30	2.37	12.60	2.22	11.70	2.05	10.90	1.90
	11	10	14.10	2.64	13.30	2.46	12.60	2.30	11.70	2.12	10.90	1.96
	9	8	14.10	2.74	13.30	2.56	12.60	2.37	11.70	2.20	10.90	2.03
	7	6	14.10	2.87	13.30	2.67	12.60	2.49	11.70	2.31	10.90	2.12
	5	4	14.10	3.02	13.30	2.82	12.60	2.61	11.70	2.43	10.90	2.23
	3	2	14.10	3.15	13.30	2.92	12.60	2.72	11.70	2.51	10.90	2.32
	0	-1	14.10	3.37	13.30	3.13	12.60	2.90	11.70	2.69	10.90	2.46
	-3	-4	14.10	3.62	13.30	3.37	12.60	3.12	11.70	2.88	10.90	2.64
	-5	-6	14.10	4.00	13.30	3.71	12.60	3.43	11.70	3.17	10.90	2.91
	-7	-8	14.10	4.23	13.30	3.93	12.60	3.62	11.70	3.34	10.90	3.06
	-10	-11	14.10	4.86	13.30	4.50	12.60	4.16	11.70	3.83	10.90	3.52
	-12	-13	13.60	4.84	13.30	4.81	12.60	4.43	11.70	4.08	10.90	3.73
	-15	-16	12.90	4.76	12.80	4.84	12.60	4.75	11.70	4.36	10.90	3.98
	-17	-18	12.10	4.53	12.10	4.63	12.10	4.71	11.70	4.55	10.90	4.15
	-20	-21	11.10	4.38	11.10	4.48	11.10	4.57	11.10	4.68	10.90	4.66
80	15	14	12.60	2.15	11.80	2.01	11.10	1.88	10.40	1.75	9.70	1.62
	13	12	12.60	2.22	11.80	2.08	11.10	1.94	10.40	1.80	9.70	1.67
	11	10	12.60	2.31	11.80	2.16	11.10	2.01	10.40	1.87	9.70	1.74
	9	8	12.60	2.38	11.80	2.22	11.10	2.08	10.40	1.93	9.70	1.78
	7	6	12.60	2.50	11.80	2.34	11.10	2.18	10.40	2.02	9.70	1.87
	5	4	12.60	2.62	11.80	2.45	11.10	2.29	10.40	2.12	9.70	1.96
	3	2	12.60	2.73	11.80	2.55	11.10	2.37	10.40	2.20	9.70	2.03
	0	-1	12.60	2.92	11.80	2.72	11.10	2.52	10.40	2.34	9.70	2.16
	-3	-4	12.60	3.13	11.80	2.92	11.10	2.71	10.40	2.50	9.70	2.31
	-5	-6	12.60	3.45	11.80	3.21	11.10	2.98	10.40	2.76	9.70	2.53

10. Capacity Table

Heating

TC : Total Capacity, PI : Power Input

Combination, % (Capacity Index)	Outdoor temperature (°C)		Indoor temperature (°C, DB)									
			16		18		20		22		24	
	DB	WB	TC kW	PI kW	TC kW	PI kW	TC kW	PI kW	TC kW	PI kW	TC kW	PI kW
80	-7	-8	12.60	3.65	11.80	3.40	11.10	3.14	10.40	2.90	9.70	2.67
	-10	-11	12.60	4.18	11.80	3.88	11.10	3.59	10.40	3.31	9.70	3.04
	-12	-13	12.60	4.45	11.80	4.13	11.10	3.82	10.40	3.53	9.70	3.22
	-15	-16	12.60	4.77	11.80	4.41	11.10	4.09	10.40	3.75	9.70	3.44
	-17	-18	12.10	4.71	11.80	4.62	11.10	4.26	10.40	3.92	9.70	3.58
	-20	-21	11.10	4.57	11.10	4.66	11.10	4.76	10.40	4.39	9.70	4.00
	15	14	11.00	1.86	10.40	1.74	9.70	1.63	9.10	1.51	8.50	1.41
70	13	12	11.00	1.91	10.40	1.79	9.70	1.68	9.10	1.56	8.50	1.46
	11	10	11.00	1.97	10.40	1.86	9.70	1.74	9.10	1.62	8.50	1.50
	9	8	11.00	2.05	10.40	1.92	9.70	1.79	9.10	1.67	8.50	1.55
	7	6	11.00	2.15	10.40	2.01	9.70	1.88	9.10	1.75	8.50	1.62
	5	4	11.00	2.25	10.40	2.10	9.70	1.96	9.10	1.82	8.50	1.69
	3	2	11.00	2.33	10.40	2.19	9.70	2.04	9.10	1.90	8.50	1.76
	0	-1	11.00	2.48	10.40	2.32	9.70	2.17	9.10	2.01	8.50	1.86
	-3	-4	11.00	2.66	10.40	2.49	9.70	2.32	9.10	2.15	8.50	1.98
	-5	-6	11.00	2.93	10.40	2.74	9.70	2.55	9.10	2.36	8.50	2.18
	-7	-8	11.00	3.10	10.40	2.88	9.70	2.69	9.10	2.48	8.50	2.29
	-10	-11	11.00	3.54	10.40	3.29	9.70	3.06	9.10	2.83	8.50	2.60
	-12	-13	11.00	3.76	10.40	3.49	9.70	3.25	9.10	3.00	8.50	2.75
	-15	-16	11.00	4.01	10.40	3.73	9.70	3.45	9.10	3.19	8.50	2.92
	-17	-18	11.00	4.20	10.40	3.89	9.70	3.59	9.10	3.32	8.50	3.04
	-20	-21	11.00	4.70	10.40	4.36	9.70	4.02	9.10	3.70	8.50	3.40
60	15	14	9.40	1.57	8.90	1.49	8.30	1.38	7.80	1.29	7.30	1.21
	13	12	9.40	1.62	8.90	1.52	8.30	1.42	7.80	1.34	7.30	1.25
	11	10	9.40	1.67	8.90	1.57	8.30	1.48	7.80	1.38	7.30	1.28
	9	8	9.40	1.74	8.90	1.62	8.30	1.52	7.80	1.42	7.30	1.33
	7	6	9.40	1.81	8.90	1.70	8.30	1.59	7.80	1.49	7.30	1.38
	5	4	9.40	1.90	8.90	1.78	8.30	1.66	7.80	1.55	7.30	1.45
	3	2	9.40	1.97	8.90	1.84	8.30	1.73	7.80	1.61	7.30	1.50
	0	-1	9.40	2.09	8.90	1.96	8.30	1.82	7.80	1.70	7.30	1.57
	-3	-4	9.40	2.23	8.90	2.09	8.30	1.95	7.80	1.82	7.30	1.67
	-5	-6	9.40	2.45	8.90	2.29	8.30	2.15	7.80	2.00	7.30	1.84
	-7	-8	9.40	2.58	8.90	2.41	8.30	2.24	7.80	2.09	7.30	1.93
	-10	-11	9.40	2.93	8.90	2.74	8.30	2.56	7.80	2.36	7.30	2.19
	-12	-13	9.40	3.12	8.90	2.90	8.30	2.71	7.80	2.50	7.30	2.31
	-15	-16	9.40	3.32	8.90	3.10	8.30	2.87	7.80	2.66	7.30	2.46
	-17	-18	9.40	3.46	8.90	3.21	8.30	2.99	7.80	2.76	7.30	2.53
-20	-21	9.40	3.86	8.90	3.58	8.30	3.33	7.80	3.07	7.30	2.82	
50	15	14	7.80	1.31	7.40	1.24	7.00	1.15	6.50	1.09	6.10	1.01
	13	12	7.80	1.35	7.40	1.26	7.00	1.20	6.50	1.12	6.10	1.05
	11	10	7.80	1.38	7.40	1.31	7.00	1.23	6.50	1.15	6.10	1.08
	9	8	7.80	1.43	7.40	1.35	7.00	1.26	6.50	1.19	6.10	1.11
	7	6	7.80	1.49	7.40	1.41	7.00	1.32	6.50	1.24	6.10	1.16
	5	4	7.80	1.55	7.40	1.47	7.00	1.38	6.50	1.29	6.10	1.20
	3	2	7.80	1.62	7.40	1.52	7.00	1.42	6.50	1.34	6.10	1.24
	0	-1	7.80	1.70	7.40	1.61	7.00	1.50	6.50	1.41	6.10	1.32
	-3	-4	7.80	1.82	7.40	1.71	7.00	1.61	6.50	1.50	6.10	1.39
	-5	-6	7.80	2.01	7.40	1.88	7.00	1.76	6.50	1.63	6.10	1.53
	-7	-8	7.80	2.10	7.40	1.97	7.00	1.83	6.50	1.71	6.10	1.59
	-10	-11	7.80	2.37	7.40	2.22	7.00	2.08	6.50	1.94	6.10	1.79
	-12	-13	7.80	2.52	7.40	2.35	7.00	2.20	6.50	2.05	6.10	1.90
	-15	-16	7.80	2.67	7.40	2.50	7.00	2.33	6.50	2.17	6.10	2.01
	-17	-18	7.80	2.77	7.40	2.59	7.00	2.41	6.50	2.23	6.10	2.07
-20	-21	7.80	3.08	7.40	2.88	7.00	2.67	6.50	2.47	6.10	2.28	

NOTE

- Capacity table may be subject to change without prior notice.
- Capacity table comply with EN14511.
- Cooling capacities are based on;
 - Indoor temperature : 27°C DB, 19°C WB
 - Outdoor temperature : 35°C DB, 24°C WB, Equivalent refrigerant piping : 7.5m, Level differences : 0m
- Heating capacities are based on;
 - Indoor temperature : 20°C DB, 15°C WB
 - Outdoor temperature : 7°C DB, 6°C WB, Equivalent refrigerant piping : 7.5m, Level differences : 0m

10. Capacity Table

AM040FXMDGH/EU

Cooling

TC : Total Capacity, PI : Power Input

Combination, % (Capacity index)	Outdoor temperature (°C, DB)	Indoor temperature (°C, WB)													
		14		16		18		19		20		22		24	
		TC kW	PI kW	TC kW	PI kW	TC kW	PI kW	TC kW	PI kW	TC kW	PI kW	TC kW	PI kW	TC kW	PI kW
130	10	10.80	1.32	12.80	1.62	14.90	1.92	16.00	2.07	16.80	2.18	17.20	2.09	17.50	1.99
	12	10.80	1.34	12.80	1.64	14.90	1.96	15.90	2.11	16.60	2.17	16.90	2.07	17.40	2.03
	14	10.80	1.37	12.80	1.68	14.90	1.99	15.90	2.15	16.30	2.15	16.70	2.14	17.10	2.15
	16	10.80	1.40	12.80	1.71	14.90	2.03	15.90	2.22	16.10	2.23	16.40	2.25	16.90	2.27
	18	10.80	1.42	12.80	1.74	14.90	2.17	15.60	2.33	15.80	2.34	16.20	2.36	16.60	2.38
	20	10.70	1.45	12.70	1.86	14.80	2.33	15.50	2.45	15.60	2.46	16.00	2.47	16.40	2.51
	21	10.70	1.49	12.70	1.92	14.80	2.42	15.30	2.51	15.50	2.52	15.90	2.54	16.30	2.56
	23	10.70	1.59	12.70	2.06	14.80	2.59	15.10	2.62	15.20	2.63	15.70	2.65	16.00	2.68
	25	10.70	1.71	12.70	2.21	14.60	2.72	14.90	2.73	15.10	2.75	15.40	2.77	15.80	2.80
	27	10.70	1.83	12.70	2.36	14.40	2.84	14.60	2.84	14.80	2.86	15.20	2.89	15.60	2.91
	29	10.70	1.95	12.70	2.52	14.20	2.94	14.40	2.96	14.60	2.98	14.90	3.01	15.40	3.03
	31	10.70	2.07	12.70	2.70	14.00	3.06	14.10	3.08	14.30	3.09	14.80	3.12	15.10	3.16
	33	10.70	2.21	12.70	2.88	13.70	3.18	14.00	3.20	14.10	3.21	14.50	3.24	14.90	3.27
	35	10.60	2.36	12.60	3.07	13.50	3.30	13.70	3.31	13.80	3.33	14.30	3.36	14.60	3.40
	37	10.30	2.51	12.20	3.27	12.80	3.41	13.10	3.43	13.20	3.45	13.60	3.49	14.00	3.52
	39	10.10	2.67	12.00	3.49	12.40	3.53	12.60	3.54	12.70	3.57	13.10	3.60	13.50	3.64
	42	10.10	2.84	12.00	3.71	12.20	3.65	12.30	3.66	12.50	3.68	13.00	3.72	13.20	3.76
	44	10.10	2.99	12.00	3.92	12.10	3.77	12.10	3.77	12.20	3.81	12.80	3.85	13.00	3.88
	46	10.10	3.16	12.00	4.14	11.90	3.90	11.80	3.89	12.00	3.93	12.60	3.97	12.70	4.00
	120	10	9.90	1.21	11.80	1.47	13.80	1.75	14.70	1.89	15.70	2.03	16.90	2.15	17.30
12		9.90	1.23	11.80	1.50	13.80	1.78	14.70	1.92	15.70	2.07	16.70	2.14	17.00	2.05
14		9.90	1.25	11.80	1.53	13.70	1.82	14.70	1.96	15.70	2.11	16.50	2.13	16.80	2.14
16		9.90	1.27	11.80	1.55	13.70	1.85	14.70	2.01	15.70	2.17	16.20	2.24	16.50	2.25
18		9.90	1.30	11.80	1.59	13.70	1.92	14.70	2.12	15.60	2.33	16.00	2.35	16.30	2.37
20		9.90	1.32	11.80	1.65	13.70	2.06	14.70	2.29	15.40	2.44	15.70	2.47	16.10	2.48
21		9.90	1.34	11.80	1.71	13.70	2.14	14.60	2.37	15.30	2.51	15.60	2.52	16.00	2.54
23		9.80	1.43	11.80	1.83	13.70	2.29	14.60	2.54	15.00	2.62	15.40	2.64	15.80	2.66
25		9.80	1.52	11.70	1.96	13.70	2.46	14.60	2.72	14.80	2.73	15.10	2.75	15.50	2.78
27		9.80	1.63	11.70	2.10	13.60	2.62	14.30	2.84	14.50	2.84	15.00	2.87	15.30	2.89
29		9.80	1.74	11.70	2.25	13.60	2.80	14.20	2.94	14.30	2.96	14.70	2.98	15.00	3.02
31		9.80	1.85	11.70	2.39	13.60	3.00	13.90	3.06	14.10	3.07	14.50	3.10	14.80	3.13
33		9.80	1.97	11.70	2.55	13.50	3.16	13.70	3.17	13.90	3.19	14.20	3.22	14.60	3.25
35		9.80	2.10	11.70	2.72	13.20	3.27	13.40	3.29	13.70	3.31	14.00	3.34	14.30	3.37
37		9.50	2.24	11.30	2.90	12.70	3.39	12.80	3.41	13.00	3.42	13.30	3.46	13.70	3.49
39		9.30	2.38	11.10	3.09	12.20	3.51	12.40	3.53	12.60	3.54	12.90	3.58	13.20	3.61
42		9.30	2.52	11.10	3.27	11.90	3.63	12.20	3.64	12.40	3.67	12.70	3.70	13.10	3.73
44		9.30	2.66	11.10	3.46	11.70	3.75	12.10	3.75	12.20	3.79	12.60	3.82	12.90	3.86
46		9.30	2.80	11.10	3.65	11.40	3.87	11.90	3.86	12.10	3.90	12.40	3.94	12.70	3.97
110		10	9.10	1.09	10.90	1.34	12.60	1.59	13.50	1.71	14.40	1.84	16.10	2.10	16.90
	12	9.10	1.12	10.90	1.36	12.60	1.61	13.50	1.74	14.40	1.88	16.10	2.14	16.70	2.13
	14	9.10	1.13	10.90	1.38	12.60	1.64	13.50	1.78	14.40	1.92	16.10	2.18	16.50	2.13
	16	9.10	1.15	10.80	1.41	12.60	1.68	13.50	1.81	14.30	1.95	15.90	2.22	16.30	2.25
	18	9.10	1.18	10.80	1.44	12.60	1.71	13.50	1.86	14.30	2.05	15.70	2.33	16.00	2.36
	20	9.10	1.20	10.80	1.47	12.60	1.81	13.40	2.00	14.30	2.20	15.50	2.45	15.80	2.47
	21	9.10	1.22	10.80	1.51	12.60	1.87	13.40	2.07	14.30	2.29	15.30	2.51	15.70	2.52
	23	9.10	1.27	10.80	1.62	12.50	2.01	13.40	2.22	14.30	2.45	15.10	2.62	15.40	2.64
	25	9.00	1.36	10.80	1.74	12.50	2.15	13.40	2.38	14.30	2.62	14.90	2.73	15.20	2.76
	27	9.00	1.45	10.80	1.85	12.50	2.30	13.40	2.55	14.30	2.80	14.60	2.85	15.00	2.87
	29	9.00	1.55	10.80	1.97	12.50	2.47	13.40	2.73	14.10	2.94	14.40	2.97	14.80	2.98
	31	9.00	1.64	10.80	2.10	12.50	2.62	13.40	2.91	13.90	3.05	14.10	3.08	14.50	3.11
	33	9.00	1.74	10.80	2.25	12.50	2.80	13.40	3.11	13.60	3.16	14.00	3.20	14.30	3.22
	35	9.00	1.86	10.70	2.39	12.40	2.99	13.20	3.27	13.40	3.29	13.70	3.31	14.00	3.35
	37	8.70	1.97	10.40	2.54	12.10	3.19	12.60	3.39	12.70	3.40	13.10	3.43	13.40	3.46
	39	8.50	2.10	10.20	2.71	11.80	3.40	12.20	3.50	12.30	3.52	12.60	3.55	12.90	3.58
	42	8.50	2.23	10.20	2.88	11.80	3.60	12.00	3.62	12.20	3.63	12.50	3.68	12.60	3.69
	44	8.50	2.36	10.20	3.05	11.80	3.82	11.80	3.73	12.00	3.75	12.30	3.79	12.40	3.81
	46	8.50	2.48	10.20	3.21	11.80	4.02	11.70	3.85	11.80	3.86	12.20	3.91	12.20	3.92
	100	10	8.30	0.99	9.90	1.19	11.50	1.41	12.30	1.53	13.10	1.65	14.60	1.88	16.30
12		8.30	1.01	9.90	1.23	11.50	1.45	12.30	1.56	13.10	1.68	14.60	1.92	16.30	2.16
14		8.30	1.02	9.90	1.24	11.50	1.47	12.30	1.59	13.00	1.71	14.60	1.96	16.20	2.19
16		8.30	1.04	9.90	1.27	11.50	1.50	12.20	1.63	13.00	1.74	14.60	1.99	15.90	2.22
18		8.30	1.06	9.90	1.29	11.40	1.53	12.20	1.66	13.00	1.78	14.60	2.10	15.70	2.33
20		8.20	1.08	9.90	1.32	11.40	1.58	12.20	1.74	13.00	1.91	14.60	2.27	15.50	2.45
21		8.20	1.09	9.90	1.33	11.40	1.63	12.20	1.80	13.00	1.97	14.60	2.35	15.30	2.51
23		8.20	1.12	9.80	1.41	11.40	1.75	12.20	1.92	13.00	2.12	14.50	2.52	15.20	2.62
25		8.20	1.19	9.80	1.52	11.40	1.87	12.20	2.07	13.00	2.27	14.50	2.70	14.90	2.74
27		8.20	1.27	9.80	1.62	11.40	2.00	12.20	2.21	13.00	2.43	14.30	2.84	14.70	2.85
29		8.20	1.36	9.80	1.73	11.40	2.14	12.20	2.36	12.90	2.59	14.20	2.94	14.40	2.97
31		8.20	1.45	9.80	1.84	11.40	2.29	12.20	2.52	12.90	2.77	13.90	3.06	14.20	3.08
33		8.20	1.54	9.80	1.96	11.40	2.43	12.10	2.69	12.90	2.96	13.70	3.17	14.00	3.20
35		8.20	1.63	9.80	2.08	11.30	2.59	12.10	2.89	12.90	3.16	13.40	3.29	13.70	3.31
37		7.90	1.74	9.50	2.21	11.00	2.76	11.70	3.05	12.50	3.36	12.80	3.41	13.10	3.44
39		7.80	1.84	9.30	2.36	10.80	2.94	11.50	3.26	12.10	3.49	12.30	3.53	12.60	3.55
42		7.80	1.95	9.30	2.50	10.80	3.12	11.50	3.46	11.90	3.63	12.10	3.64	12.50	3.67
44		7.80	2.06	9.30	2.64	10.80	3.31	11.50	3.66	11.70	3.77	11.80	3.75	12.30	3.78
46		7.80	2.16	9.30	2.78	10.80	3.49	11.50	3.86	11.60	3.90	11.60	3.86	12.20	3.90
90		10	7.50	0.89	8.90	1.07	10.40	1.26	11.10	1.36	11.80	1.46	13.20	1.66	14.60
	12	7.50	0.90	8.90	1.08	10.30	1.28	11.00	1.38	11.70	1.49	13.20	1.70	14.60	1.92
	14	7.40	0.91	8.80	1.11	10.30	1.31	11.00	1.41	11.70	1.52	13.20	1.74	14.60	1.96
	16	7.40	0.93	8.80	1.13	10.30	1.33	11.00	1.44	11.70	1.55	13.20	1.77	14.60	1.99
	18	7.40	0.95	8.80	1.15	10.30	1.36	11.00	1.46	11.70	1.58	13.20	1.80	14.60	2.10
	20	7.40	0.97	8.80	1.17	10.30	1.38	11.00	1.50	11.70	1.64	13.20	1.93	14.60	2.26

10. Capacity Table

Cooling

TC : Total Capacity, PI : Power Input

Combination, % (Capacity index)	Outdoor temperature (°C, DB)	Indoor temperature (°C, WB)															
		14		16		18		19		20		22		24			
		TC kW	PI kW	TC kW	PI kW	TC kW	PI kW	TC kW	PI kW	TC kW	PI kW	TC kW	PI kW	TC kW	PI kW		
90	37	7.10	1.50	8.50	1.92	9.90	2.36	10.60	2.62	11.20	2.87	12.60	3.38	12.80	3.41		
	39	7.00	1.59	8.30	2.03	9.70	2.52	10.30	2.78	11.00	3.05	12.10	3.49	12.30	3.53		
	42	7.00	1.69	8.30	2.14	9.70	2.67	10.30	2.94	11.00	3.24	11.80	3.61	12.10	3.64		
	44	7.00	1.78	8.30	2.25	9.70	2.83	10.30	3.12	11.00	3.43	11.60	3.72	11.80	3.75		
	46	7.00	1.88	8.30	2.37	9.70	2.98	10.30	3.28	11.00	3.62	11.30	3.84	11.60	3.86		
	10	6.60	0.79	7.90	0.94	9.20	1.10	9.80	1.19	10.40	1.27	11.80	1.45	13.00	1.64		
	12	6.60	0.80	7.90	0.95	9.20	1.12	9.80	1.21	10.40	1.30	11.70	1.48	13.00	1.67		
80	14	6.60	0.81	7.90	0.97	9.20	1.15	9.80	1.23	10.40	1.32	11.70	1.51	13.00	1.70		
	16	6.60	0.82	7.90	1.00	9.20	1.17	9.80	1.26	10.40	1.35	11.70	1.55	12.90	1.74		
	18	6.60	0.84	7.90	1.01	9.20	1.19	9.80	1.28	10.40	1.37	11.70	1.57	12.90	1.77		
	20	6.60	0.86	7.90	1.03	9.20	1.21	9.80	1.31	10.40	1.41	11.70	1.63	12.90	1.89		
	21	6.60	0.86	7.90	1.04	9.20	1.23	9.80	1.32	10.40	1.43	11.70	1.69	12.90	1.96		
	23	6.60	0.88	7.90	1.05	9.10	1.28	9.80	1.41	10.40	1.53	11.70	1.81	12.90	2.10		
	25	6.60	0.90	7.80	1.13	9.10	1.37	9.70	1.50	10.40	1.64	11.70	1.93	12.90	2.25		
	27	6.60	0.96	7.80	1.20	9.10	1.46	9.70	1.60	10.30	1.75	11.70	2.07	12.90	2.41		
	29	6.60	1.02	7.80	1.27	9.10	1.55	9.70	1.71	10.30	1.87	11.60	2.21	12.90	2.58		
	31	6.60	1.08	7.80	1.36	9.10	1.66	9.70	1.82	10.30	1.99	11.60	2.36	12.80	2.75		
	33	6.60	1.15	7.80	1.45	9.10	1.77	9.70	1.94	10.30	2.12	11.60	2.51	12.80	2.94		
	35	6.50	1.23	7.80	1.53	9.10	1.88	9.70	2.07	10.30	2.26	11.60	2.68	12.80	3.13		
	37	6.30	1.30	7.60	1.63	8.80	2.00	9.40	2.20	10.00	2.40	11.20	2.85	12.40	3.35		
	39	6.20	1.37	7.40	1.73	8.60	2.12	9.20	2.33	9.80	2.57	11.00	3.04	12.10	3.49		
42	6.20	1.45	7.40	1.83	8.60	2.25	9.20	2.47	9.80	2.73	11.00	3.23	12.00	3.65			
44	6.20	1.54	7.40	1.92	8.60	2.36	9.20	2.62	9.80	2.89	11.00	3.42	11.90	3.81			
46	6.20	1.62	7.40	2.03	8.60	2.48	9.20	2.76	9.80	3.05	11.00	3.60	11.80	3.96			
70	10	5.80	0.69	6.90	0.82	8.00	0.95	8.60	1.03	9.10	1.10	10.30	1.25	11.40	1.41		
	12	5.80	0.70	6.90	0.83	8.00	0.97	8.60	1.04	9.10	1.12	10.30	1.27	11.40	1.43		
	14	5.80	0.71	6.90	0.85	8.00	0.99	8.60	1.07	9.10	1.14	10.20	1.30	11.40	1.45		
	16	5.80	0.72	6.90	0.86	8.00	1.01	8.60	1.08	9.10	1.16	10.20	1.32	11.40	1.49		
	18	5.80	0.73	6.90	0.88	8.00	1.03	8.60	1.10	9.10	1.18	10.20	1.35	11.40	1.52		
	20	5.80	0.75	6.90	0.90	8.00	1.04	8.60	1.13	9.10	1.21	10.20	1.37	11.30	1.55		
	21	5.80	0.75	6.90	0.90	8.00	1.05	8.50	1.13	9.10	1.23	10.20	1.40	11.30	1.62		
	23	5.80	0.76	6.90	0.92	8.00	1.08	8.50	1.18	9.10	1.27	10.20	1.50	11.30	1.74		
	25	5.80	0.78	6.90	0.95	8.00	1.15	8.50	1.26	9.00	1.37	10.20	1.59	11.30	1.85		
	27	5.70	0.82	6.90	1.01	8.00	1.23	8.50	1.34	9.00	1.45	10.20	1.70	11.30	1.98		
	29	5.70	0.87	6.90	1.08	8.00	1.30	8.50	1.42	9.00	1.55	10.20	1.82	11.30	2.11		
	31	5.70	0.93	6.80	1.15	8.00	1.39	8.50	1.52	9.00	1.65	10.20	1.94	11.30	2.25		
	33	5.70	0.99	6.80	1.22	7.90	1.48	8.50	1.61	9.00	1.76	10.10	2.07	11.30	2.40		
	35	5.70	1.04	6.80	1.29	7.90	1.56	8.50	1.71	9.00	1.87	10.10	2.20	11.20	2.56		
37	5.50	1.10	6.60	1.37	7.70	1.66	8.20	1.82	8.70	1.99	9.80	2.34	10.90	2.73			
39	5.40	1.17	6.50	1.45	7.50	1.77	8.00	1.93	8.50	2.11	9.60	2.49	10.70	2.91			
42	5.40	1.23	6.50	1.53	7.50	1.87	8.00	2.05	8.50	2.25	9.60	2.64	10.70	3.09			
44	5.40	1.30	6.50	1.61	7.50	1.96	8.00	2.16	8.50	2.37	9.60	2.79	10.70	3.27			
46	5.40	1.37	6.50	1.69	7.50	2.07	8.00	2.28	8.50	2.50	9.60	2.94	10.70	3.45			
60	10	5.00	0.60	5.90	0.71	6.90	0.81	7.40	0.87	7.80	0.93	8.80	1.05	9.70	1.18		
	12	5.00	0.61	5.90	0.71	6.90	0.82	7.40	0.89	7.80	0.95	8.80	1.08	9.70	1.20		
	14	5.00	0.62	5.90	0.72	6.90	0.85	7.40	0.90	7.80	0.97	8.80	1.09	9.70	1.23		
	16	5.00	0.62	5.90	0.74	6.90	0.86	7.30	0.92	7.80	0.98	8.70	1.12	9.70	1.25		
	18	5.00	0.64	5.90	0.75	6.90	0.87	7.30	0.93	7.80	1.00	8.70	1.13	9.70	1.27		
	20	5.00	0.64	5.90	0.76	6.90	0.89	7.30	0.95	7.80	1.02	8.70	1.15	9.70	1.30		
	21	4.90	0.65	5.90	0.77	6.80	0.90	7.30	0.96	7.80	1.03	8.70	1.17	9.70	1.31		
	23	4.90	0.67	5.90	0.79	6.80	0.91	7.30	0.98	7.80	1.04	8.70	1.22	9.70	1.40		
	25	4.90	0.67	5.90	0.80	6.80	0.95	7.30	1.03	7.80	1.12	8.70	1.30	9.70	1.49		
	27	4.90	0.70	5.90	0.85	6.80	1.01	7.30	1.09	7.80	1.19	8.70	1.38	9.70	1.59		
	29	4.90	0.74	5.90	0.90	6.80	1.08	7.30	1.17	7.80	1.26	8.70	1.47	9.60	1.69		
	31	4.90	0.79	5.90	0.95	6.80	1.14	7.30	1.24	7.80	1.34	8.70	1.56	9.60	1.81		
	33	4.90	0.82	5.90	1.01	6.80	1.21	7.30	1.32	7.80	1.43	8.70	1.66	9.60	1.92		
	35	4.90	0.87	5.80	1.07	6.80	1.28	7.30	1.40	7.70	1.52	8.60	1.77	9.60	2.05		
37	4.80	0.93	5.70	1.13	6.60	1.37	7.00	1.48	7.50	1.61	8.40	1.88	9.30	2.18			
39	4.70	0.98	5.50	1.19	6.40	1.45	6.90	1.57	7.30	1.71	8.20	2.00	9.10	2.32			
42	4.70	1.04	5.50	1.26	6.40	1.52	6.90	1.66	7.30	1.81	8.20	2.11	9.10	2.46			
44	4.70	1.08	5.50	1.32	6.40	1.60	6.90	1.74	7.30	1.92	8.20	2.23	9.10	2.60			
46	4.70	1.14	5.50	1.37	6.40	1.69	6.90	1.83	7.30	2.01	8.20	2.34	9.10	2.74			
50	10	4.10	0.52	4.90	0.60	5.70	0.68	6.10	0.72	6.50	0.77	7.30	0.87	8.10	0.97		
	12	4.10	0.53	4.90	0.60	5.70	0.69	6.10	0.74	6.50	0.79	7.30	0.89	8.10	0.99		
	14	4.10	0.53	4.90	0.62	5.70	0.71	6.10	0.75	6.50	0.80	7.30	0.90	8.10	1.00		
	16	4.10	0.53	4.90	0.62	5.70	0.71	6.10	0.76	6.50	0.81	7.30	0.91	8.10	1.02		
	18	4.10	0.54	4.90	0.63	5.70	0.72	6.10	0.78	6.50	0.82	7.30	0.93	8.10	1.04		
	20	4.10	0.55	4.90	0.64	5.70	0.74	6.10	0.79	6.50	0.84	7.30	0.95	8.10	1.06		
	21	4.10	0.56	4.90	0.65	5.70	0.75	6.10	0.80	6.50	0.85	7.30	0.96	8.10	1.07		
	23	4.10	0.57	4.90	0.66	5.70	0.76	6.10	0.81	6.50	0.86	7.30	0.97	8.10	1.09		
	25	4.10	0.57	4.90	0.67	5.70	0.77	6.10	0.82	6.50	0.90	7.30	1.03	8.10	1.17		
	27	4.10	0.58	4.90	0.69	5.70	0.81	6.10	0.88	6.50	0.95	7.30	1.08	8.10	1.24		
	29	4.10	0.62	4.90	0.73	5.70	0.86	6.10	0.93	6.50	1.01	7.30	1.16	8.10	1.32		
	31	4.10	0.65	4.90	0.78	5.70	0.92	6.10	1.00	6.50	1.07	7.30	1.23	8.10	1.41		
	33	4.10	0.68	4.90	0.82	5.70	0.97	6.10	1.05	6.50	1.13	7.30	1.31	8.00	1.50		
	35	4.10	0.72	4.90	0.87	5.70	1.03	6.10	1.12	6.40	1.20	7.20	1.39	8.00	1.59		
37	4.00	0.76	4.70	0.92	5.50	1.08	5.90	1.18	6.30	1.27	7.00	1.48	7.80	1.69			
39	3.90	0.81	4.60	0.97	5.40	1.15	5.70	1.25	6.10	1.35	6.90	1.56	7.60	1.79			
42	3.90	0.85	4.60	1.03	5.40	1.23	5.70	1.32	6.10	1.42	6.90	1.65	7.60	1.89			
44	3.90	0.89	4.60	1.08	5.40	1.29	5.70	1.38	6.10	1.50	6.90	1.74	7.60	1.99			
46	3.90	0.93	4.60	1.13	5.40	1.36	5.70	1.45	6.10	1.57	6.90	1.83	7.60	2.10			

NOTE

- Capacity table may be subject to change without prior notice.
- Capacity table comply with EN14511.
- Cooling capacities are based on;
 - Indoor temperature : 27°C DB, 19°C WB
 - Outdoor temperature : 35°C DB, 24°C WB, Equivalent refrigerant piping : 7.5m, Level differences : 0m
- Heating capacities are based on;
 - Indoor temperature : 20°C DB, 15°C WB
 - Outdoor temperature : 7°C DB, 6°C WB, Equivalent refrigerant piping : 7.5m, Level differences : 0m

10. Capacity Table

Heating

TC : Total Capacity, PI : Power Input

Combination, % (Capacity index)	Outdoor temperature (°C)		Indoor temperature (°C, DB)													
			16		18		20		22		24					
			TC kW	PI kW	TC kW	PI kW	TC kW	PI kW	TC kW	PI kW	TC kW	PI kW				
130	DB	WB														
	15	14	20.40	3.85	19.20	3.57	18.10	3.30	16.90	3.05	15.80	2.80				
	13	12	20.40	3.99	19.20	3.70	18.10	3.42	16.90	3.16	15.80	2.90				
	11	10	20.40	4.15	19.20	3.86	18.10	3.56	16.90	3.29	15.80	3.01				
	9	8	20.40	4.33	19.20	4.01	18.10	3.70	16.90	3.41	15.80	3.13				
	7	6	20.10	4.47	19.20	4.22	18.10	3.89	16.90	3.58	15.80	3.28				
	5	4	19.60	4.47	19.20	4.45	18.10	4.11	16.90	3.78	15.80	3.45				
	3	2	18.90	4.41	18.80	4.50	18.10	4.29	16.90	3.94	15.80	3.60				
	0	-1	17.90	4.34	17.90	4.41	17.80	4.51	16.90	4.22	15.80	3.86				
	-3	-4	16.90	4.23	16.80	4.33	16.80	4.41	16.80	4.51	15.80	4.16				
	-5	-6	16.20	4.37	16.20	4.47	16.10	4.57	16.10	4.67	15.80	4.61				
	-7	-8	15.60	4.28	15.50	4.39	15.50	4.50	15.50	4.61	15.50	4.69				
	-10	-11	14.40	4.28	14.40	4.40	14.40	4.52	14.40	4.64	14.20	4.76				
	-12	-13	13.70	4.17	13.70	4.30	13.70	4.42	13.60	4.54	13.60	4.67				
	-15	-16	13.00	4.06	13.00	4.18	13.00	4.31	12.90	4.44	12.90	4.56				
	-17	-18	12.30	3.81	12.30	3.95	12.20	4.08	12.20	4.22	12.20	4.35				
	-20	-21	11.40	3.58	11.40	3.73	11.20	3.87	11.20	4.02	11.20	4.17				
120	15	14	18.80	3.47	17.80	3.24	16.70	3.00	15.60	2.77	14.60	2.55				
	13	12	18.80	3.60	17.80	3.35	16.70	3.11	15.60	2.87	14.60	2.63				
	11	10	18.80	3.75	17.80	3.48	16.70	3.22	15.60	2.98	14.60	2.73				
	9	8	18.80	3.89	17.80	3.62	16.70	3.35	15.60	3.08	14.60	2.83				
	7	6	18.80	4.11	17.80	3.81	16.70	3.52	15.60	3.25	14.60	2.98				
	5	4	18.80	4.34	17.80	4.01	16.70	3.71	15.60	3.41	14.60	3.13				
	3	2	18.80	4.52	17.80	4.20	16.70	3.87	15.60	3.56	14.60	3.26				
	0	-1	17.80	4.44	17.80	4.50	16.70	4.15	15.60	3.82	14.60	3.48				
	-3	-4	16.80	4.35	16.80	4.43	16.70	4.49	15.60	4.11	14.60	3.75				
	-5	-6	16.10	4.51	16.10	4.59	16.10	4.68	15.60	4.55	14.60	4.14				
	-7	-8	15.50	4.42	15.50	4.53	15.50	4.63	15.50	4.71	14.60	4.39				
	-10	-11	14.40	4.44	14.40	4.54	14.20	4.66	14.20	4.77	14.20	4.88				
	-12	-13	13.70	4.34	13.70	4.45	13.60	4.56	13.60	4.68	13.60	4.80				
	-15	-16	13.00	4.23	12.90	4.35	12.90	4.47	12.90	4.59	12.90	4.71				
	-17	-18	12.30	3.99	12.20	4.12	12.20	4.24	12.20	4.36	12.20	4.49				
	-20	-21	11.20	3.79	11.20	3.92	11.20	4.06	11.20	4.18	11.10	4.33				
	110	15	14	17.20	3.13	16.20	2.91	15.30	2.70	14.40	2.49	13.30	2.30			
13		12	17.20	3.24	16.20	3.01	15.30	2.79	14.40	2.58	13.30	2.37				
11		10	17.20	3.37	16.20	3.13	15.30	2.90	14.40	2.69	13.30	2.46				
9		8	17.20	3.49	16.20	3.25	15.30	3.01	14.40	2.78	13.30	2.56				
7		6	17.20	3.68	16.20	3.42	15.30	3.16	14.40	2.92	13.30	2.67				
5		4	17.20	3.87	16.20	3.59	15.30	3.32	14.40	3.07	13.30	2.82				
3		2	17.20	4.03	16.20	3.75	15.30	3.47	14.40	3.20	13.30	2.92				
0		-1	17.20	4.34	16.20	4.02	15.30	3.72	14.40	3.42	13.30	3.13				
-3		-4	16.80	4.48	16.20	4.35	15.30	4.01	14.40	3.69	13.30	3.38				
-5		-6	16.10	4.64	16.10	4.71	15.30	4.43	14.40	4.07	13.30	3.72				
-7		-8	15.50	4.57	15.50	4.66	15.30	4.68	14.40	4.30	13.30	3.94				
-10		-11	14.40	4.61	14.20	4.70	14.20	4.80	14.20	4.90	13.30	4.51				
-12		-13	13.60	4.51	13.60	4.62	13.60	4.71	13.60	4.82	13.30	4.81				
-15		-16	12.90	4.40	12.90	4.51	12.90	4.63	12.90	4.73	12.80	4.84				
-17		-18	12.20	4.17	12.20	4.28	12.20	4.40	12.20	4.51	12.10	4.63				
-20		-21	11.20	3.98	11.20	4.10	11.20	4.23	11.10	4.35	11.10	4.48				
100		15	14	15.70	2.63	14.80	2.46	13.80	2.29	13.00	2.11	12.10	1.96			
	13	12	15.70	2.73	14.80	2.55	13.80	2.42	13.00	2.19	12.10	2.03				
	11	10	15.70	2.84	14.80	2.64	13.80	2.67	13.00	2.27	12.10	2.09				
	9	8	15.70	2.94	14.80	2.74	13.80	2.86	13.00	2.35	12.10	2.17				
	7	6	15.70	3.10	14.80	2.88	13.50	3.02	13.00	2.47	12.10	2.28				
	5	4	15.70	3.25	14.80	3.02	13.50	3.17	13.00	2.59	12.10	2.38				
	3	2	15.70	3.40	14.80	3.16	13.50	3.25	13.00	2.70	12.10	2.48				
	0	-1	15.70	3.63	14.80	3.38	13.50	3.37	13.00	2.88	12.10	2.65				
	-3	-4	15.70	3.92	14.80	3.65	13.50	3.49	13.00	3.10	12.10	2.84				
	-5	-6	15.70	4.34	14.80	4.01	13.50	3.71	13.00	3.41	12.10	3.13				
	-7	-8	15.50	4.45	14.80	4.26	13.50	3.93	13.00	3.60	12.10	3.30				
	-10	-11	14.20	4.50	14.20	4.58	13.50	4.51	13.00	4.14	12.10	3.79				
	-12	-13	13.60	4.43	13.60	4.51	13.30	4.61	13.00	4.42	12.10	4.03				
	-15	-16	12.90	4.34	12.90	4.43	12.90	4.52	12.80	4.62	12.10	4.31				
	-17	-18	12.20	4.12	12.20	4.22	12.10	4.31	12.10	4.41	12.10	4.50				
	-20	-21	11.20	3.95	11.10	4.07	11.10	4.16	11.10	4.28	11.10	4.38				
	90	15	14	14.10	2.46	13.30	2.30	12.60	2.14	11.70	1.98	10.90	1.84			
13		12	14.10	2.55	13.30	2.37	12.60	2.22	11.70	2.05	10.90	1.90				
11		10	14.10	2.64	13.30	2.46	12.60	2.30	11.70	2.12	10.90	1.96				
9		8	14.10	2.74	13.30	2.56	12.60	2.37	11.70	2.20	10.90	2.03				
7		6	14.10	2.87	13.30	2.67	12.60	2.49	11.70	2.31	10.90	2.12				
5		4	14.10	3.02	13.30	2.82	12.60	2.61	11.70	2.43	10.90	2.23				
3		2	14.10	3.15	13.30	2.92	12.60	2.72	11.70	2.51	10.90	2.32				
0		-1	14.10	3.37	13.30	3.13	12.60	2.90	11.70	2.69	10.90	2.46				
-3		-4	14.10	3.62	13.30	3.37	12.60	3.12	11.70	2.88	10.90	2.64				
-5		-6	14.10	4.00	13.30	3.71	12.60	3.43	11.70	3.17	10.90	2.91				
-7		-8	14.10	4.23	13.30	3.93	12.60	3.62	11.70	3.34	10.90	3.06				
-10		-11	14.10	4.86	13.30	4.50	12.60	4.16	11.70	3.83	10.90	3.52				
-12		-13	13.60	4.84	13.30	4.81	12.60	4.43	11.70	4.08	10.90	3.73				
-15		-16	12.90	4.76	12.80	4.84	12.60	4.75	11.70	4.36	10.90	3.98				
-17		-18	12.10	4.53	12.10	4.63	12.10	4.71	11.70	4.55	10.90	4.15				
-20		-21	11.10	4.38	11.10	4.48	11.10	4.57	11.10	4.68	10.90	4.66				
80		15	14	12.60	2.15	11.80	2.01									

10. Capacity Table

Heating

TC : Total Capacity, PI : Power Input

Combination, % (Capacity Index)	Outdoor temperature (°C)		Indoor temperature (°C, DB)											
			16		18		20		22		24			
			TC kW	PI kW	TC kW	PI kW	TC kW	PI kW	TC kW	PI kW	TC kW	PI kW		
80	DB	WB												
	-7	-8	12.60	3.65	11.80	3.40	11.10	3.14	10.40	2.90	9.70	2.67		
	-10	-11	12.60	4.18	11.80	3.88	11.10	3.59	10.40	3.31	9.70	3.04		
	-12	-13	12.60	4.45	11.80	4.13	11.10	3.82	10.40	3.53	9.70	3.22		
	-15	-16	12.60	4.77	11.80	4.41	11.10	4.09	10.40	3.75	9.70	3.44		
	-17	-18	12.10	4.71	11.80	4.62	11.10	4.26	10.40	3.92	9.70	3.58		
	-20	-21	11.10	4.57	11.10	4.66	11.10	4.76	10.40	4.39	9.70	4.00		
70	15	14	11.00	1.86	10.40	1.74	9.70	1.63	9.10	1.51	8.50	1.41		
	13	12	11.00	1.91	10.40	1.79	9.70	1.68	9.10	1.56	8.50	1.46		
	11	10	11.00	1.97	10.40	1.86	9.70	1.74	9.10	1.62	8.50	1.50		
	9	8	11.00	2.05	10.40	1.92	9.70	1.79	9.10	1.67	8.50	1.55		
	7	6	11.00	2.15	10.40	2.01	9.70	1.88	9.10	1.75	8.50	1.62		
	5	4	11.00	2.25	10.40	2.10	9.70	1.96	9.10	1.82	8.50	1.69		
	3	2	11.00	2.33	10.40	2.19	9.70	2.04	9.10	1.90	8.50	1.76		
	0	-1	11.00	2.48	10.40	2.32	9.70	2.17	9.10	2.01	8.50	1.86		
	-3	-4	11.00	2.66	10.40	2.49	9.70	2.32	9.10	2.15	8.50	1.98		
	-5	-6	11.00	2.93	10.40	2.74	9.70	2.55	9.10	2.36	8.50	2.18		
	-7	-8	11.00	3.10	10.40	2.88	9.70	2.69	9.10	2.48	8.50	2.29		
	-10	-11	11.00	3.54	10.40	3.29	9.70	3.06	9.10	2.83	8.50	2.60		
	-12	-13	11.00	3.76	10.40	3.49	9.70	3.25	9.10	3.00	8.50	2.75		
	-15	-16	11.00	4.01	10.40	3.73	9.70	3.45	9.10	3.19	8.50	2.92		
	-17	-18	11.00	4.20	10.40	3.89	9.70	3.59	9.10	3.32	8.50	3.04		
-20	-21	11.00	4.70	10.40	4.36	9.70	4.02	9.10	3.70	8.50	3.40			
60	15	14	9.40	1.57	8.90	1.49	8.30	1.38	7.80	1.29	7.30	1.21		
	13	12	9.40	1.62	8.90	1.52	8.30	1.42	7.80	1.34	7.30	1.25		
	11	10	9.40	1.67	8.90	1.57	8.30	1.48	7.80	1.38	7.30	1.28		
	9	8	9.40	1.74	8.90	1.62	8.30	1.52	7.80	1.42	7.30	1.33		
	7	6	9.40	1.81	8.90	1.70	8.30	1.59	7.80	1.49	7.30	1.38		
	5	4	9.40	1.90	8.90	1.78	8.30	1.66	7.80	1.55	7.30	1.45		
	3	2	9.40	1.97	8.90	1.84	8.30	1.73	7.80	1.61	7.30	1.50		
	0	-1	9.40	2.09	8.90	1.96	8.30	1.82	7.80	1.70	7.30	1.57		
	-3	-4	9.40	2.23	8.90	2.09	8.30	1.95	7.80	1.82	7.30	1.67		
	-5	-6	9.40	2.45	8.90	2.29	8.30	2.15	7.80	2.00	7.30	1.84		
	-7	-8	9.40	2.58	8.90	2.41	8.30	2.24	7.80	2.09	7.30	1.93		
	-10	-11	9.40	2.93	8.90	2.74	8.30	2.56	7.80	2.36	7.30	2.19		
	-12	-13	9.40	3.12	8.90	2.90	8.30	2.71	7.80	2.50	7.30	2.31		
	-15	-16	9.40	3.32	8.90	3.10	8.30	2.87	7.80	2.66	7.30	2.46		
	-17	-18	9.40	3.46	8.90	3.21	8.30	2.99	7.80	2.76	7.30	2.53		
-20	-21	9.40	3.86	8.90	3.58	8.30	3.33	7.80	3.07	7.30	2.82			
50	15	14	7.80	1.31	7.40	1.24	7.00	1.15	6.50	1.09	6.10	1.01		
	13	12	7.80	1.35	7.40	1.26	7.00	1.20	6.50	1.12	6.10	1.05		
	11	10	7.80	1.38	7.40	1.31	7.00	1.23	6.50	1.15	6.10	1.08		
	9	8	7.80	1.43	7.40	1.35	7.00	1.26	6.50	1.19	6.10	1.11		
	7	6	7.80	1.49	7.40	1.41	7.00	1.32	6.50	1.24	6.10	1.16		
	5	4	7.80	1.55	7.40	1.47	7.00	1.38	6.50	1.29	6.10	1.20		
	3	2	7.80	1.62	7.40	1.52	7.00	1.42	6.50	1.34	6.10	1.24		
	0	-1	7.80	1.70	7.40	1.61	7.00	1.50	6.50	1.41	6.10	1.32		
	-3	-4	7.80	1.82	7.40	1.71	7.00	1.61	6.50	1.50	6.10	1.39		
	-5	-6	7.80	2.01	7.40	1.88	7.00	1.76	6.50	1.63	6.10	1.53		
	-7	-8	7.80	2.10	7.40	1.97	7.00	1.83	6.50	1.71	6.10	1.59		
	-10	-11	7.80	2.37	7.40	2.22	7.00	2.08	6.50	1.94	6.10	1.79		
	-12	-13	7.80	2.52	7.40	2.35	7.00	2.20	6.50	2.05	6.10	1.90		
	-15	-16	7.80	2.67	7.40	2.50	7.00	2.33	6.50	2.17	6.10	2.01		
	-17	-18	7.80	2.77	7.40	2.59	7.00	2.41	6.50	2.23	6.10	2.07		
-20	-21	7.80	3.08	7.40	2.88	7.00	2.67	6.50	2.47	6.10	2.28			

NOTE

- Capacity table may be subject to change without prior notice.
- Capacity table comply with EN14511.
- Cooling capacities are based on;
 - Indoor temperature : 27°C DB, 19°C WB
 - Outdoor temperature : 35°C DB, 24°C WB, Equivalent refrigerant piping : 7.5m, Level differences : 0m
- Heating capacities are based on;
 - Indoor temperature : 20°C DB, 15°C WB
 - Outdoor temperature : 7°C DB, 6°C WB, Equivalent refrigerant piping : 7.5m, Level differences : 0m

10. Capacity Table

AM050FXMDEH/EU

Cooling

TC : Total Capacity, PI : Power Input

Combination, % (Capacity index)	Outdoor temperature (°C, DB)	Indoor temperature (°C, WB)													
		14		16		18		19		20		22		24	
		TC kW	PI kW	TC kW	PI kW	TC kW	PI kW	TC kW	PI kW	TC kW	PI kW	TC kW	PI kW	TC kW	PI kW
130	10	12.50	1.68	14.80	2.06	17.30	2.44	18.50	2.64	19.40	2.78	19.90	2.66	20.30	2.53
	12	12.50	1.71	14.80	2.09	17.20	2.50	18.50	2.69	19.20	2.74	19.60	2.64	20.10	2.59
	14	12.50	1.74	14.80	2.14	17.20	2.54	18.40	2.74	18.80	2.74	19.40	2.72	19.80	2.74
	16	12.50	1.78	14.80	2.18	17.20	2.59	18.40	2.83	18.60	2.84	19.00	2.86	19.50	2.89
	18	12.40	1.81	14.80	2.22	17.20	2.76	18.10	2.97	18.30	2.98	18.80	3.01	19.20	3.03
	20	12.40	1.85	14.80	2.27	17.20	2.97	17.90	3.12	18.10	3.13	18.50	3.15	19.00	3.19
	21	12.40	1.90	14.70	2.45	17.20	3.08	17.70	3.19	18.00	3.21	18.40	3.23	18.90	3.26
	23	12.40	2.03	14.70	2.62	17.10	3.30	17.40	3.33	17.60	3.35	18.10	3.38	18.60	3.41
	25	12.40	2.18	14.70	2.81	16.90	3.46	17.20	3.48	17.40	3.50	17.80	3.53	18.30	3.56
	27	12.40	2.33	14.70	3.01	16.70	3.61	16.90	3.62	17.10	3.64	17.60	3.68	18.00	3.71
	29	12.40	2.48	14.70	3.21	16.40	3.75	16.70	3.77	16.90	3.80	17.30	3.83	17.80	3.86
	31	12.40	2.64	14.70	3.44	16.20	3.90	16.40	3.92	16.60	3.94	17.10	3.97	17.50	4.02
	33	12.30	2.82	14.60	3.67	15.90	4.05	16.20	4.07	16.40	4.09	16.80	4.13	17.30	4.17
	35	12.30	3.00	14.60	3.91	15.60	4.20	15.80	4.21	16.00	4.24	16.50	4.28	16.90	4.33
	37	11.90	3.20	14.20	4.17	14.80	4.34	15.10	4.37	15.30	4.39	15.70	4.44	16.20	4.48
	39	11.70	3.40	13.90	4.44	14.40	4.50	14.50	4.51	14.70	4.54	15.20	4.59	15.60	4.63
42	11.70	3.61	13.90	4.72	14.20	4.65	14.30	4.66	14.40	4.69	15.00	4.74	15.30	4.79	
44	11.70	3.81	13.90	4.99	14.00	4.80	14.00	4.80	14.20	4.85	14.80	4.90	15.00	4.94	
46	11.70	4.02	13.90	5.27	13.80	4.96	13.70	4.95	13.90	5.00	14.60	5.05	14.70	5.09	
120	10	11.50	1.54	13.70	1.87	15.90	2.23	17.10	2.41	18.20	2.59	19.60	2.74	20.00	2.63
	12	11.50	1.56	13.70	1.91	15.90	2.27	17.00	2.45	18.20	2.64	19.30	2.73	19.70	2.61
	14	11.50	1.59	13.70	1.95	15.90	2.32	17.00	2.50	18.10	2.69	19.00	2.71	19.50	2.73
	16	11.40	1.62	13.70	1.98	15.90	2.36	17.00	2.56	18.10	2.76	18.70	2.85	19.10	2.87
	18	11.40	1.66	13.70	2.03	15.90	2.44	17.00	2.70	18.10	2.97	18.50	2.99	18.90	3.02
	20	11.40	1.68	13.60	2.10	15.90	2.62	17.00	2.91	17.80	3.11	18.20	3.14	18.60	3.16
	21	11.40	1.70	13.60	2.18	15.80	2.72	17.00	3.02	17.70	3.19	18.10	3.21	18.50	3.24
	23	11.40	1.82	13.60	2.33	15.80	2.91	16.90	3.23	17.30	3.33	17.80	3.36	18.20	3.39
	25	11.40	1.94	13.60	2.50	15.80	3.13	16.90	3.46	17.10	3.48	17.50	3.50	17.90	3.54
	27	11.40	2.08	13.60	2.68	15.80	3.34	16.60	3.61	16.80	3.62	17.30	3.65	17.70	3.68
	29	11.40	2.21	13.60	2.86	15.80	3.57	16.40	3.75	16.60	3.77	17.00	3.80	17.40	3.84
	31	11.40	2.36	13.60	3.04	15.80	3.82	16.10	3.90	16.30	3.91	16.80	3.95	17.20	3.98
	33	11.30	2.51	13.50	3.25	15.70	4.03	15.90	4.04	16.10	4.06	16.50	4.10	16.90	4.14
	35	11.30	2.68	13.50	3.46	15.30	4.17	15.50	4.19	15.80	4.21	16.20	4.25	16.60	4.29
	37	11.00	2.85	13.10	3.69	14.70	4.32	14.80	4.34	15.00	4.36	15.40	4.40	15.80	4.44
	39	10.70	3.03	12.80	3.93	14.10	4.47	14.40	4.49	14.50	4.51	14.90	4.56	15.30	4.60
42	10.70	3.21	12.80	4.17	13.80	4.62	14.20	4.63	14.40	4.67	14.70	4.71	15.10	4.75	
44	10.70	3.39	12.80	4.41	13.50	4.78	14.00	4.78	14.20	4.82	14.50	4.86	14.90	4.91	
46	10.70	3.56	12.80	4.65	13.20	4.93	13.80	4.92	14.00	4.97	14.40	5.02	14.70	5.06	
110	10	10.60	1.39	12.60	1.70	14.60	2.02	15.60	2.18	16.70	2.34	18.70	2.68	19.60	2.73
	12	10.60	1.42	12.60	1.73	14.60	2.05	15.60	2.22	16.60	2.39	18.70	2.73	19.40	2.71
	14	10.50	1.44	12.60	1.76	14.60	2.09	15.60	2.27	16.60	2.44	18.60	2.78	19.00	2.71
	16	10.50	1.47	12.60	1.80	14.60	2.14	15.60	2.31	16.60	2.48	18.40	2.83	18.80	2.86
	18	10.50	1.50	12.50	1.83	14.60	2.18	15.60	2.37	16.60	2.61	18.20	2.97	18.50	3.00
	20	10.50	1.53	12.50	1.87	14.50	2.31	15.60	2.55	16.60	2.80	17.90	3.12	18.30	3.15
	21	10.50	1.55	12.50	1.92	14.50	2.38	15.50	2.64	16.60	2.91	17.80	3.19	18.20	3.21
	23	10.50	1.62	12.50	2.06	14.50	2.56	15.50	2.83	16.50	3.12	17.40	3.33	17.80	3.36
	25	10.50	1.73	12.50	2.21	14.50	2.74	15.50	3.03	16.50	3.34	17.20	3.48	17.60	3.51
	27	10.50	1.84	12.50	2.35	14.50	2.93	15.50	3.25	16.50	3.57	16.90	3.63	17.30	3.66
	29	10.50	1.97	12.50	2.51	14.50	3.14	15.50	3.47	16.30	3.74	16.70	3.78	17.10	3.80
	31	10.40	2.09	12.50	2.68	14.50	3.34	15.50	3.71	16.10	3.89	16.40	3.92	16.80	3.96
	33	10.40	2.22	12.40	2.86	14.40	3.57	15.50	3.96	15.80	4.03	16.20	4.07	16.60	4.10
	35	10.40	2.37	12.40	3.04	14.40	3.81	15.30	4.17	15.50	4.19	15.80	4.22	16.20	4.26
	37	10.10	2.51	12.00	3.24	14.00	4.06	14.60	4.32	14.70	4.33	15.10	4.37	15.50	4.41
	39	9.90	2.68	11.80	3.45	13.70	4.33	14.10	4.46	14.30	4.48	14.60	4.52	14.90	4.56
42	9.90	2.84	11.80	3.67	13.70	4.59	13.90	4.61	14.10	4.62	14.40	4.68	14.60	4.70	
44	9.90	3.00	11.80	3.88	13.70	4.86	13.70	4.75	13.90	4.77	14.30	4.83	14.40	4.85	
46	9.90	3.16	11.80	4.09	13.70	5.12	13.50	4.90	13.70	4.92	14.10	4.98	14.10	4.99	
100	10	9.60	1.26	11.50	1.52	13.30	1.80	14.20	1.95	15.10	2.10	17.00	2.40	18.90	2.70
	12	9.60	1.28	11.50	1.56	13.30	1.84	14.20	1.99	15.10	2.14	16.90	2.44	18.90	2.75
	14	9.60	1.30	11.50	1.58	13.30	1.87	14.20	2.03	15.10	2.18	16.90	2.49	18.70	2.79
	16	9.60	1.32	11.40	1.62	13.30	1.91	14.20	2.07	15.10	2.22	16.90	2.54	18.40	2.83
	18	9.60	1.35	11.40	1.64	13.20	1.95	14.20	2.11	15.10	2.27	16.90	2.68	18.20	2.97
	20	9.50	1.38	11.40	1.68	13.20	2.01	14.10	2.21	15.10	2.43	16.90	2.89	17.90	3.12
	21	9.50	1.39	11.40	1.69	13.20	2.08	14.10	2.29	15.00	2.51	16.90	2.99	17.80	3.20
	23	9.50	1.43	11.40	1.80	13.20	2.23	14.10	2.45	15.00	2.70	16.80	3.21	17.50	3.34
	25	9.50	1.52	11.40	1.93	13.20	2.38	14.10	2.63	15.00	2.89	16.80	3.44	17.20	3.49
	27	9.50	1.62	11.40	2.06	13.20	2.55	14.10	2.81	15.00	3.09	16.60	3.61	17.00	3.63
	29	9.50	1.73	11.40	2.20	13.20	2.72	14.10	3.01	15.00	3.30	16.40	3.75	16.70	3.78
	31	9.50	1.84	11.40	2.34	13.20	2.91	14.10	3.21	15.00	3.53	16.10	3.90	16.50	3.92
	33	9.50	1.96	11.30	2.49	13.10	3.09	14.00	3.42	14.90	3.77	15.90	4.04	16.20	4.08
	35	9.50	2.08	11.30	2.65	13.10	3.30	14.00	3.68	14.90	4.02	15.50	4.19	15.90	4.22
	37	9.20	2.21	11.00	2.82	12.70	3.51	13.60	3.89	14.50	4.28	14.80	4.34	15.10	4.38
	39	9.00	2.34	10.70	3.00	12.50	3.74	13.30	4.15	14.00	4.45	14.30	4.49	14.60	4.52
42	9.00	2.48	10.70	3.18	12.50	3.97	13.30	4.40	13.80	4.62	14.00	4.63	14.40	4.67	
44	9.00	2.62	10.70	3.36	12.50	4.21	13.30	4.66	13.60	4.80	13.70	4.78	14.30	4.81	
46	9.00	2.75	10.70	3.54	12.50	4.44	13.30	4.92	13.40	4.97	13.40	4.92	14.10	4.96	
90	10	8.60	1.13	10.30	1.36	12.00	1.61	12.80	1.73	13.60	1.86	15.30	2.12	17.00	2.39
	12	8.60	1.15	10.20	1.38	12.00	1.63	12.80	1.76	13.60	1.90	15.30	2.16	16.90	2.44
	14	8.60	1.16	10.20	1.41	12.00	1.67	12.80	1.80	13.60	1.93	15.30	2.21	16.90	2.49
	16	8.60	1.19	10.20	1.44	11.90	1.69	12.80	1.83	13.60	1.97	15.30	2.25	16.90	2.53
	18	8.60	1.21	10.20	1.46	11.90	1.73	12.70	1.86	13.60	2.01	15.30	2.29	16.90	2.68
	20	8.60	1.23	10.20	1.49	11.90	1.76	12.70	1.91	13					

10. Capacity Table

Cooling

TC : Total Capacity, PI : Power Input

Combination, % (Capacity index)	Outdoor temperature (°C, DB)	Indoor temperature (°C, WB)															
		14		16		18		19		20		22		24			
		TC kW	PI kW	TC kW	PI kW	TC kW	PI kW	TC kW	PI kW	TC kW	PI kW	TC kW	PI kW	TC kW	PI kW		
90	37	8.30	1.91	9.80	2.44	11.50	3.01	12.20	3.33	13.00	3.65	14.60	4.31	14.80	4.34		
	39	8.10	2.03	9.60	2.58	11.20	3.21	12.00	3.54	12.70	3.89	14.00	4.45	14.30	4.49		
	42	8.10	2.15	9.60	2.73	11.20	3.40	12.00	3.75	12.70	4.13	13.70	4.60	14.00	4.63		
	44	8.10	2.27	9.60	2.87	11.20	3.60	12.00	3.97	12.70	4.37	13.40	4.74	13.70	4.78		
	46	8.10	2.39	9.60	3.02	11.20	3.80	12.00	4.18	12.70	4.61	13.10	4.89	13.40	4.92		
	10	7.70	1.00	9.20	1.20	10.70	1.40	11.40	1.51	12.10	1.62	13.60	1.85	15.00	2.09		
	12	7.70	1.02	9.20	1.21	10.70	1.43	11.40	1.54	12.10	1.66	13.60	1.89	15.00	2.13		
	14	7.70	1.03	9.10	1.24	10.60	1.46	11.40	1.57	12.10	1.68	13.60	1.92	15.00	2.17		
	16	7.70	1.05	9.10	1.27	10.60	1.49	11.30	1.60	12.00	1.72	13.60	1.97	15.00	2.21		
	18	7.60	1.07	9.10	1.28	10.60	1.51	11.30	1.63	12.00	1.75	13.60	2.00	15.00	2.26		
20	7.60	1.09	9.10	1.31	10.60	1.54	11.30	1.67	12.00	1.79	13.50	2.08	15.00	2.41			
21	7.60	1.09	9.10	1.32	10.60	1.56	11.30	1.68	12.00	1.82	13.50	2.15	14.90	2.50			
23	7.60	1.12	9.10	1.34	10.60	1.63	11.30	1.79	12.00	1.95	13.50	2.30	14.90	2.68			
25	7.60	1.15	9.10	1.44	10.60	1.74	11.30	1.91	12.00	2.09	13.50	2.46	14.90	2.87			
27	7.60	1.22	9.10	1.53	10.60	1.86	11.30	2.04	12.00	2.23	13.50	2.63	14.90	3.07			
29	7.60	1.30	9.10	1.62	10.60	1.98	11.30	2.18	12.00	2.38	13.50	2.81	14.90	3.28			
31	7.60	1.38	9.10	1.73	10.50	2.11	11.20	2.32	12.00	2.54	13.50	3.00	14.90	3.50			
33	7.60	1.47	9.10	1.84	10.50	2.25	11.20	2.47	11.90	2.70	13.40	3.20	14.80	3.74			
35	7.60	1.56	9.00	1.95	10.50	2.39	11.20	2.63	11.90	2.88	13.40	3.41	14.80	3.99			
37	7.30	1.65	8.80	2.07	10.20	2.55	10.90	2.80	11.50	3.06	13.00	3.63	14.40	4.26			
39	7.20	1.75	8.60	2.20	10.00	2.70	10.60	2.97	11.30	3.27	12.70	3.87	14.00	4.45			
42	7.20	1.85	8.60	2.33	10.00	2.86	10.60	3.15	11.30	3.47	12.70	4.11	13.90	4.65			
44	7.20	1.96	8.60	2.45	10.00	3.01	10.60	3.33	11.30	3.68	12.70	4.35	13.80	4.85			
46	7.20	2.06	8.60	2.58	10.00	3.16	10.60	3.51	11.30	3.88	12.70	4.59	13.70	5.04			
10	6.70	0.88	8.00	1.04	9.30	1.21	10.00	1.31	10.60	1.40	11.90	1.59	13.20	1.79			
12	6.70	0.89	8.00	1.06	9.30	1.24	9.90	1.33	10.60	1.43	11.90	1.62	13.20	1.82			
14	6.70	0.91	8.00	1.08	9.30	1.26	9.90	1.36	10.50	1.45	11.90	1.65	13.20	1.85			
16	6.70	0.92	8.00	1.09	9.30	1.28	9.90	1.38	10.50	1.48	11.80	1.68	13.20	1.90			
18	6.70	0.93	8.00	1.12	9.30	1.31	9.90	1.40	10.50	1.50	11.80	1.72	13.10	1.93			
20	6.70	0.95	8.00	1.14	9.30	1.33	9.90	1.44	10.50	1.54	11.80	1.75	13.10	1.98			
21	6.70	0.96	8.00	1.15	9.20	1.34	9.90	1.44	10.50	1.56	11.80	1.78	13.10	2.06			
23	6.70	0.97	8.00	1.17	9.20	1.37	9.90	1.50	10.50	1.62	11.80	1.91	13.10	2.21			
25	6.70	0.99	8.00	1.21	9.20	1.46	9.90	1.60	10.50	1.74	11.80	2.03	13.10	2.36			
27	6.70	1.05	7.90	1.29	9.20	1.56	9.90	1.70	10.50	1.85	11.80	2.17	13.10	2.52			
29	6.60	1.11	7.90	1.38	9.20	1.66	9.90	1.81	10.50	1.97	11.80	2.32	13.10	2.69			
31	6.60	1.18	7.90	1.46	9.20	1.77	9.80	1.93	10.40	2.10	11.80	2.47	13.10	2.87			
33	6.60	1.26	7.90	1.55	9.20	1.88	9.80	2.05	10.40	2.24	11.70	2.63	13.00	3.06			
35	6.60	1.32	7.90	1.64	9.20	1.99	9.80	2.18	10.40	2.38	11.70	2.80	13.00	3.26			
37	6.40	1.40	7.70	1.74	8.90	2.12	9.50	2.32	10.10	2.53	11.40	2.98	12.60	3.47			
39	6.30	1.49	7.50	1.85	8.70	2.25	9.30	2.46	9.90	2.69	11.10	3.17	12.40	3.70			
42	6.30	1.57	7.50	1.95	8.70	2.38	9.30	2.61	9.90	2.86	11.10	3.36	12.40	3.93			
44	6.30	1.66	7.50	2.05	8.70	2.50	9.30	2.75	9.90	3.02	11.10	3.55	12.40	4.16			
46	6.30	1.74	7.50	2.15	8.70	2.63	9.30	2.90	9.90	3.18	11.10	3.74	12.40	4.39			
10	5.80	0.76	6.90	0.90	8.00	1.03	8.50	1.11	9.10	1.19	10.20	1.34	11.30	1.50			
12	5.80	0.78	6.90	0.91	8.00	1.05	8.50	1.13	9.10	1.21	10.10	1.37	11.30	1.53			
14	5.70	0.79	6.90	0.92	8.00	1.08	8.50	1.15	9.10	1.23	10.10	1.39	11.20	1.56			
16	5.70	0.79	6.80	0.94	7.90	1.09	8.50	1.17	9.10	1.25	10.10	1.42	11.20	1.59			
18	5.70	0.81	6.80	0.96	7.90	1.11	8.50	1.19	9.10	1.27	10.10	1.44	11.20	1.62			
21	5.70	0.82	6.80	0.97	7.90	1.13	8.50	1.21	9.00	1.30	10.10	1.47	11.20	1.65			
23	5.70	0.83	6.80	0.98	7.90	1.14	8.50	1.22	9.00	1.31	10.10	1.49	11.20	1.67			
25	5.70	0.85	6.80	1.00	7.90	1.16	8.50	1.25	9.00	1.33	10.10	1.55	11.20	1.73			
27	5.70	0.85	6.80	1.02	7.90	1.21	8.50	1.31	9.00	1.42	10.10	1.65	11.20	1.90			
29	5.70	0.89	6.80	1.08	7.90	1.28	8.50	1.39	9.00	1.51	10.10	1.76	11.20	2.03			
31	5.70	0.94	6.80	1.15	7.90	1.37	8.40	1.49	9.00	1.61	10.10	1.87	11.20	2.15			
33	5.70	1.00	6.80	1.21	7.90	1.45	8.40	1.58	9.00	1.71	10.00	1.99	11.10	2.30			
35	5.70	1.05	6.80	1.28	7.90	1.54	8.40	1.68	9.00	1.82	10.00	2.12	11.10	2.44			
37	5.70	1.11	6.80	1.36	7.90	1.63	8.40	1.78	9.00	1.93	10.00	2.26	11.10	2.61			
39	5.50	1.18	6.60	1.44	7.60	1.74	8.20	1.89	8.70	2.05	9.70	2.40	10.80	2.77			
42	5.40	1.25	6.40	1.52	7.50	1.84	8.00	2.00	8.50	2.18	9.50	2.55	10.60	2.95			
44	5.40	1.32	6.40	1.60	7.50	1.94	8.00	2.11	8.50	2.31	9.50	2.69	10.60	3.13			
46	5.40	1.38	6.40	1.68	7.50	2.04	8.00	2.22	8.50	2.44	9.50	2.84	10.60	3.31			
10	4.80	0.66	5.70	0.76	6.60	0.87	7.10	0.92	7.60	0.98	8.50	1.11	9.40	1.23			
12	4.80	0.67	5.70	0.77	6.60	0.88	7.10	0.94	7.60	1.00	8.50	1.13	9.40	1.26			
14	4.80	0.68	5.70	0.79	6.60	0.90	7.10	0.96	7.60	1.02	8.50	1.15	9.40	1.27			
16	4.80	0.68	5.70	0.79	6.60	0.91	7.10	0.97	7.60	1.03	8.50	1.16	9.40	1.30			
18	4.80	0.69	5.70	0.80	6.60	0.92	7.10	0.99	7.50	1.05	8.50	1.19	9.40	1.32			
20	4.80	0.70	5.70	0.82	6.60	0.94	7.10	1.01	7.50	1.07	8.50	1.21	9.40	1.35			
21	4.80	0.71	5.70	0.83	6.60	0.95	7.10	1.02	7.50	1.08	8.50	1.22	9.40	1.36			
23	4.80	0.72	5.70	0.84	6.60	0.97	7.10	1.03	7.50	1.10	8.40	1.24	9.40	1.39			
25	4.80	0.73	5.70	0.85	6.60	0.98	7.10	1.05	7.50	1.14	8.40	1.31	9.30	1.49			
27	4.80	0.74	5.70	0.88	6.60	1.03	7.00	1.12	7.50	1.21	8.40	1.38	9.30	1.58			
29	4.70	0.79	5.70	0.93	6.60	1.10	7.00	1.19	7.50	1.28	8.40	1.48	9.30	1.68			
31	4.70	0.83	5.70	0.99	6.60	1.17	7.00	1.27	7.50	1.36	8.40	1.57	9.30	1.80			
33	4.70	0.87	5.70	1.05	6.60	1.24	7.00	1.34	7.50	1.44	8.40	1.67	9.30	1.91			
35	4.70	0.92	5.60	1.11	6.50	1.31	7.00	1.42	7.50	1.53	8.40	1.77	9.30	2.03			
37	4.60	0.97	5.50	1.17	6.30	1.38	6.80	1.50	7.20	1.62	8.10	1.88	9.00	2.15			
39	4.50	1.03	5.40	1.24	6.20	1.47	6.70	1.59	7.10	1.72	8.00	1.99	8.80	2.28			
42	4.50	1.08	5.40	1.31	6.20	1.56	6.70	1.68	7.10	1.81	8.00	2.10	8.80	2.41			
44	4.50	1.13	5.40	1.38	6.20	1.64	6.70	1.76	7.10	1.91	8.00	2.21	8.80	2.54			
46	4.50	1.18	5.40	1.44	6.20	1.73	6.70	1.85	7.10	2.00	8.00	2.33	8.80	2.67			

NOTE

- Capacity table may be subject to change without prior notice.
- Capacity table comply with EN14511.
- Cooling capacities are based on;
 - Indoor temperature : 27°C DB, 19°C WB
 - Outdoor temperature : 35°C DB, 24°C WB, Equivalent refrigerant piping : 7.5m, Level differences : 0m
- Heating capacities are based on;
 - Indoor temperature : 20°C DB, 15°C WB
 - Outdoor temperature : 7°C DB, 6°C WB, Equivalent refrigerant piping : 7.5m, Level differences : 0m

10. Capacity Table

Heating

TC : Total Capacity, PI : Power Input

Combination, % (Capacity index)	Outdoor temperature (°C)		Indoor temperature (°C, DB)									
			16		18		20		22		24	
	DB	WB	TC kW	PI kW	TC kW	PI kW	TC kW	PI kW	TC kW	PI kW	TC kW	PI kW
130	15	14	22.90	4.55	22.80	4.63	21.40	4.29	20.10	3.95	18.60	3.63
	13	12	22.20	4.50	22.20	4.59	21.40	4.45	20.10	4.10	18.60	3.76
	11	10	21.50	4.45	21.40	4.54	21.40	4.62	20.10	4.26	18.60	3.91
	9	8	20.90	4.39	20.80	4.49	20.80	4.58	20.10	4.42	18.60	4.06
	7	6	20.20	4.38	20.20	4.48	20.20	4.58	20.10	4.65	18.60	4.26
	5	4	19.60	4.36	19.60	4.47	19.50	4.57	19.50	4.67	18.60	4.48
	3	2	19.00	4.30	18.90	4.40	18.90	4.50	18.90	4.62	18.60	4.67
	0	-1	17.90	4.18	17.90	4.30	17.80	4.41	17.80	4.52	17.80	4.63
	-3	-4	16.90	4.06	16.90	4.18	16.90	4.30	16.80	4.41	16.80	4.53
	-5	-6	16.30	4.17	16.30	4.30	16.20	4.42	16.20	4.56	16.20	4.69
	-7	-8	15.70	4.06	15.60	4.20	15.60	4.33	15.50	4.47	15.50	4.60
	-10	-11	14.40	4.01	14.40	4.16	14.40	4.31	14.30	4.46	14.30	4.61
	-12	-13	13.80	3.87	13.70	4.03	13.70	4.18	13.70	4.35	13.60	4.50
	-15	-16	13.10	3.71	13.10	3.88	13.00	4.05	13.00	4.21	13.00	4.38
	-17	-18	12.50	3.44	12.40	3.61	12.40	3.79	12.30	3.96	12.30	4.13
	-20	-21	11.40	3.16	11.30	3.34	11.30	3.53	11.30	3.72	11.20	3.91
	120	15	14	22.40	4.51	21.00	4.20	19.80	3.89	18.50	3.60	17.20
13		12	22.20	4.62	21.00	4.35	19.80	4.03	18.50	3.72	17.20	3.42
11		10	21.40	4.57	21.00	4.52	19.80	4.19	18.50	3.86	17.20	3.55
9		8	20.80	4.52	20.80	4.61	19.80	4.35	18.50	4.01	17.20	3.68
7		6	20.20	4.51	20.10	4.61	19.80	4.58	18.50	4.22	17.20	3.86
5		4	19.60	4.50	19.50	4.60	19.50	4.69	18.50	4.43	17.20	4.06
3		2	18.90	4.44	18.90	4.54	18.90	4.63	18.50	4.62	17.20	4.23
0		-1	17.90	4.33	17.80	4.44	17.80	4.54	17.80	4.64	17.20	4.53
-3		-4	16.90	4.22	16.90	4.33	16.80	4.44	16.80	4.55	16.80	4.65
-5		-6	16.30	4.34	16.20	4.46	16.20	4.58	16.20	4.70	16.10	4.82
-7		-8	15.60	4.25	15.60	4.37	15.50	4.49	15.50	4.62	15.50	4.75
-10		-11	14.40	4.21	14.30	4.35	14.30	4.49	14.30	4.63	14.20	4.78
-12		-13	13.70	4.08	13.70	4.22	13.70	4.38	13.60	4.52	13.60	4.67
-15		-16	13.10	3.94	13.00	4.09	13.00	4.24	13.00	4.40	12.90	4.56
-17		-18	12.40	3.67	12.40	3.83	12.30	3.99	12.30	4.15	12.30	4.31
-20		-21	11.30	3.40	11.30	3.58	11.30	3.75	11.20	3.93	11.20	4.10
110		15	14	20.50	4.06	19.30	3.78	18.10	3.50	17.00	3.25	15.80
	13	12	20.50	4.20	19.30	3.91	18.10	3.63	17.00	3.36	15.80	3.09
	11	10	20.50	4.37	19.30	4.06	18.10	3.77	17.00	3.48	15.80	3.20
	9	8	20.50	4.54	19.30	4.22	18.10	3.91	17.00	3.61	15.80	3.32
	7	6	20.10	4.64	19.30	4.44	18.10	4.11	17.00	3.79	15.80	3.48
	5	4	19.50	4.63	19.30	4.67	18.10	4.32	17.00	3.98	15.80	3.66
	3	2	18.90	4.58	18.80	4.67	18.10	4.50	17.00	4.16	15.80	3.81
	0	-1	17.80	4.48	17.80	4.58	17.80	4.67	17.00	4.44	15.80	4.07
	-3	-4	16.80	4.38	16.80	4.47	16.80	4.58	16.70	4.68	15.80	4.38
	-5	-6	16.20	4.52	16.20	4.63	16.10	4.74	16.10	4.85	15.80	4.83
	-7	-8	15.60	4.42	15.50	4.54	15.50	4.66	15.50	4.77	15.40	4.89
	-10	-11	14.30	4.42	14.30	4.54	14.30	4.67	14.20	4.81	14.20	4.93
	-12	-13	13.70	4.30	13.60	4.43	13.60	4.56	13.60	4.70	13.60	4.84
	-15	-16	13.00	4.16	13.00	4.31	13.00	4.45	12.90	4.59	12.90	4.73
	-17	-18	12.40	3.91	12.30	4.05	12.30	4.20	12.30	4.35	12.20	4.50
	-20	-21	11.30	3.66	11.20	3.82	11.20	3.98	11.20	4.14	11.10	4.30
	100	15	14	18.60	3.52	17.50	3.29	16.20	3.05	15.50	2.83	14.30
13		12	18.60	3.64	17.50	3.39	16.20	3.16	15.50	2.92	14.30	2.70
11		10	18.60	3.79	17.50	3.53	16.20	3.28	15.50	3.03	14.30	2.80
9		8	18.60	3.93	17.50	3.66	16.20	3.39	15.50	3.14	14.30	2.89
7		6	18.60	4.12	17.50	3.84	16.00	3.61	15.50	3.29	14.30	3.03
5		4	18.60	4.34	17.50	4.04	16.00	3.75	15.50	3.46	14.30	3.18
3		2	18.60	4.53	17.50	4.21	16.00	3.90	15.50	3.60	14.30	3.31
0		-1	17.80	4.51	17.50	4.50	16.00	4.17	15.50	3.85	14.30	3.53
-3		-4	16.80	4.42	16.80	4.50	16.00	4.49	15.50	4.14	14.30	3.79
-5		-6	16.20	4.56	16.10	4.66	15.80	4.77	15.50	4.56	14.30	4.18
-7		-8	15.50	4.49	15.50	4.59	15.10	4.69	15.40	4.79	14.30	4.41
-10		-11	14.30	4.49	14.30	4.61	14.10	4.73	14.20	4.84	14.20	4.96
-12		-13	13.60	4.39	13.60	4.51	13.50	4.63	13.50	4.75	13.50	4.87
-15		-16	13.00	4.27	12.90	4.40	12.80	4.53	12.90	4.65	12.90	4.78
-17		-18	12.30	4.03	12.30	4.16	12.10	4.29	12.20	4.41	12.20	4.55
-20		-21	11.20	3.82	11.20	3.95	11.20	4.10	11.10	4.23	11.10	4.38
90		15	14	16.80	3.19	15.80	2.98	14.80	2.78	13.90	2.58	12.90
	13	12	16.80	3.30	15.80	3.08	14.80	2.87	13.90	2.67	12.90	2.47
	11	10	16.80	3.43	15.80	3.20	14.80	2.98	13.90	2.76	12.90	2.55
	9	8	16.80	3.55	15.80	3.31	14.80	3.08	13.90	2.86	12.90	2.64
	7	6	16.80	3.73	15.80	3.48	14.80	3.23	13.90	2.99	12.90	2.76
	5	4	16.80	3.92	15.80	3.65	14.80	3.39	13.90	3.15	12.90	2.89
	3	2	16.80	4.08	15.80	3.80	14.80	3.53	13.90	3.27	12.90	3.01
	0	-1	16.80	4.36	15.80	4.06	14.80	3.77	13.90	3.48	12.90	3.20
	-3	-4	16.70	4.70	15.80	4.37	14.80	4.05	13.90	3.74	12.90	3.44
	-5	-6	16.10	4.87	15.80	4.83	14.80	4.46	13.90	4.12	12.90	3.78
	-7	-8	15.50	4.80	15.40	4.89	14.80	4.72	13.90	4.34	12.90	3.98
	-10	-11	14.20	4.83	14.20	4.93	14.20	5.03	13.90	4.97	12.90	4.55
	-12	-13	13.60	4.72	13.60	4.84	13.50	4.95	13.50	5.06	12.90	4.84
	-15	-16	12.90	4.62	12.90	4.73	12.90	4.85	12.80	4.97	12.80	5.08
	-17	-18	12.30	4.38	12.20	4.50	12.20	4.61	12.20	4.73	12.20	4.85
	-20	-21	11.20	4.17	11.10	4.30	11.10	4.43	11.10	4.56	11.10	4.69
	80	15	14	14.80	2.79	14.00	2.61	13.20	2.44	12.40	2.27	11.50
13		12	14.80	2.88	14.00	2.70	13.20	2.51	12.40	2.34	11.50	2.17
11		10	14.80	2.99	14.00	2.80	13.20	2.61	12.40	2.42	11.50	2.25
9		8	14.80	3.09	14.00	2.89	13.20	2.70	12.40	2.50	11.50	2.32
7		6	14.80	3.24	14.00	3.03	13.20	2.83	12.40	2.62	11.50	2.43
5		4	14.80	3.41	14.00	3.18	13.20	2.96	12.40	2.74	11.50	2.54
3		2	14.80	3.55	14.00	3.30	13.20	3.08	12.40	2.86	11.50	2.64
0		-1	14.80	3.78	14.00	3.53	13.20	3.28	12.40	3.03	11.50	2.80
-3		-4	14.80	4.06	14.00	3.79	13.20	3.52	12.40	3.25	11.50	3.00
-5		-6	14.80	4.48	14.00	4.18	13.20	3.87	12.40	3.58	11.50	3.29

10. Capacity Table

Heating

TC : Total Capacity, PI : Power Input

Combination, % (Capacity index)	Outdoor temperature (°C)		Indoor temperature (°C, DB)									
			16		18		20		22		24	
	DB	WB	TC kW	PI kW	TC kW	PI kW	TC kW	PI kW	TC kW	PI kW	TC kW	PI kW
80	-7	-8	14.80	4.73	14.00	4.40	13.20	4.08	12.40	3.76	11.50	3.47
	-10	-11	14.20	5.03	14.00	5.04	13.20	4.66	12.40	4.31	11.50	3.95
	-12	-13	13.50	4.94	13.50	5.04	13.20	4.96	12.40	4.57	11.50	4.19
	-15	-16	12.90	4.85	12.80	4.95	12.80	5.05	12.40	4.88	11.50	4.47
	-17	-18	12.20	4.60	12.20	4.71	12.20	4.82	12.10	4.92	11.50	4.65
	-20	-21	11.10	4.43	11.10	4.54	11.10	4.65	11.10	4.77	11.00	4.89
70	15	14	13.00	2.40	12.30	2.26	11.50	2.11	10.80	1.97	10.10	1.83
	13	12	13.00	2.49	12.30	2.33	11.50	2.18	10.80	2.04	10.10	1.89
	11	10	13.00	2.57	12.30	2.41	11.50	2.26	10.80	2.10	10.10	1.95
	9	8	13.00	2.66	12.30	2.50	11.50	2.33	10.80	2.17	10.10	2.01
	7	6	13.00	2.78	12.30	2.60	11.50	2.44	10.80	2.27	10.10	2.10
	5	4	13.00	2.92	12.30	2.73	11.50	2.55	10.80	2.37	10.10	2.20
	3	2	13.00	3.03	12.30	2.84	11.50	2.65	10.80	2.46	10.10	2.27
	0	-1	13.00	3.23	12.30	3.02	11.50	2.82	10.80	2.61	10.10	2.42
	-3	-4	13.00	3.46	12.30	3.24	11.50	3.01	10.80	2.79	10.10	2.58
	-5	-6	13.00	3.81	12.30	3.56	11.50	3.31	10.80	3.07	10.10	2.83
	-7	-8	13.00	4.02	12.30	3.75	11.50	3.48	10.80	3.22	10.10	2.97
	-10	-11	13.00	4.59	12.30	4.28	11.50	3.97	10.80	3.66	10.10	3.38
	-12	-13	13.00	4.89	12.30	4.54	11.50	4.21	10.80	3.89	10.10	3.58
	-15	-16	12.80	5.07	12.30	4.85	11.50	4.49	10.80	4.14	10.10	3.81
-17	-18	12.20	4.84	12.10	4.93	11.50	4.67	10.80	4.31	10.10	3.95	
-20	-21	11.10	4.67	11.10	4.78	11.00	4.88	10.80	4.81	10.10	4.41	
60	15	14	11.10	2.05	10.50	1.92	9.90	1.81	9.30	1.69	8.60	1.58
	13	12	11.10	2.10	10.50	1.98	9.90	1.85	9.30	1.73	8.60	1.61
	11	10	11.10	2.17	10.50	2.05	9.90	1.92	9.30	1.79	8.60	1.67
	9	8	11.10	2.25	10.50	2.11	9.90	1.98	9.30	1.84	8.60	1.72
	7	6	11.10	2.34	10.50	2.21	9.90	2.07	9.30	1.93	8.60	1.80
	5	4	11.10	2.46	10.50	2.31	9.90	2.16	9.30	2.01	8.60	1.87
	3	2	11.10	2.56	10.50	2.40	9.90	2.24	9.30	2.09	8.60	1.94
	0	-1	11.10	2.71	10.50	2.54	9.90	2.38	9.30	2.21	8.60	2.05
	-3	-4	11.10	2.90	10.50	2.71	9.90	2.54	9.30	2.36	8.60	2.18
	-5	-6	11.10	3.18	10.50	2.98	9.90	2.78	9.30	2.59	8.60	2.39
	-7	-8	11.10	3.35	10.50	3.13	9.90	2.92	9.30	2.71	8.60	2.51
	-10	-11	11.10	3.82	10.50	3.56	9.90	3.32	9.30	3.07	8.60	2.84
	-12	-13	11.10	4.05	10.50	3.78	9.90	3.51	9.30	3.26	8.60	3.00
	-15	-16	11.10	4.31	10.50	4.02	9.90	3.73	9.30	3.45	8.60	3.18
-17	-18	11.10	4.49	10.50	4.18	9.90	3.87	9.30	3.58	8.60	3.29	
-20	-21	11.00	4.93	10.50	4.66	9.90	4.32	9.30	3.98	8.60	3.66	
50	15	14	9.30	1.70	8.80	1.60	8.20	1.50	7.70	1.41	7.20	1.32
	13	12	9.30	1.74	8.80	1.64	8.20	1.55	7.70	1.45	7.20	1.36
	11	10	9.30	1.80	8.80	1.70	8.20	1.60	7.70	1.50	7.20	1.40
	9	8	9.30	1.85	8.80	1.75	8.20	1.64	7.70	1.54	7.20	1.44
	7	6	9.30	1.94	8.80	1.83	8.20	1.71	7.70	1.60	7.20	1.50
	5	4	9.30	2.02	8.80	1.91	8.20	1.79	7.70	1.68	7.20	1.56
	3	2	9.30	2.10	8.80	1.98	8.20	1.85	7.70	1.73	7.20	1.62
	0	-1	9.30	2.22	8.80	2.09	8.20	1.96	7.70	1.83	7.20	1.70
	-3	-4	9.30	2.37	8.80	2.23	8.20	2.08	7.70	1.95	7.20	1.81
	-5	-6	9.30	2.60	8.80	2.44	8.20	2.28	7.70	2.12	7.20	1.98
	-7	-8	9.30	2.72	8.80	2.56	8.20	2.39	7.70	2.22	7.20	2.06
	-10	-11	9.30	3.09	8.80	2.90	8.20	2.70	7.70	2.51	7.20	2.33
	-12	-13	9.30	3.27	8.80	3.06	8.20	2.86	7.70	2.65	7.20	2.46
	-15	-16	9.30	3.47	8.80	3.24	8.20	3.02	7.70	2.81	7.20	2.60
-17	-18	9.30	3.60	8.80	3.36	8.20	3.14	7.70	2.91	7.20	2.69	
-20	-21	9.30	4.01	8.80	3.74	8.20	3.47	7.70	3.22	7.20	2.97	

NOTE

- Capacity table may be subject to change without prior notice.
- Capacity table comply with EN14511.
- Cooling capacities are based on;
 - Indoor temperature : 27°C DB, 19°C WB
 - Outdoor temperature : 35°C DB, 24°C WB, Equivalent refrigerant piping : 7.5m, Level differences : 0m
- Heating capacities are based on;
 - Indoor temperature : 20°C DB, 15°C WB
 - Outdoor temperature : 7°C DB, 6°C WB, Equivalent refrigerant piping : 7.5m, Level differences : 0m

10. Capacity Table

AM050FXMDGH/EU

Cooling

TC : Total Capacity, PI : Power Input

Combination, % (Capacity index)	Outdoor temperature (°C, DB)	Indoor temperature (°C, WB)													
		14		16		18		19		20		22		24	
		TC kW	PI kW	TC kW	PI kW	TC kW	PI kW	TC kW	PI kW	TC kW	PI kW	TC kW	PI kW	TC kW	PI kW
130	10	12.50	1.68	14.80	2.06	17.30	2.44	18.50	2.64	19.40	2.78	19.90	2.66	20.30	2.53
	12	12.50	1.71	14.80	2.09	17.20	2.50	18.50	2.69	19.20	2.76	19.60	2.64	20.10	2.59
	14	12.50	1.74	14.80	2.14	17.20	2.54	18.40	2.74	18.80	2.74	19.40	2.72	19.80	2.74
	16	12.50	1.78	14.80	2.18	17.20	2.59	18.40	2.83	18.60	2.84	19.00	2.86	19.50	2.89
	18	12.40	1.81	14.80	2.22	17.20	2.76	18.10	2.97	18.30	2.98	18.80	3.01	19.20	3.03
	20	12.40	1.85	14.80	2.37	17.20	2.97	17.90	3.12	18.10	3.13	18.50	3.15	19.00	3.19
	21	12.40	1.90	14.70	2.45	17.20	3.08	17.70	3.19	18.00	3.21	18.40	3.23	18.90	3.26
	23	12.40	2.03	14.70	2.62	17.10	3.30	17.40	3.33	17.60	3.35	18.10	3.38	18.60	3.41
	25	12.40	2.18	14.70	2.81	16.90	3.46	17.20	3.48	17.40	3.50	17.80	3.53	18.30	3.56
	27	12.40	2.33	14.70	3.01	16.70	3.61	16.90	3.62	17.10	3.64	17.60	3.68	18.00	3.71
	29	12.40	2.48	14.70	3.21	16.40	3.75	16.70	3.77	16.90	3.80	17.30	3.83	17.80	3.86
	31	12.40	2.64	14.70	3.44	16.20	3.90	16.40	3.92	16.60	3.94	17.10	3.97	17.50	4.02
	33	12.30	2.82	14.60	3.67	15.90	4.05	16.20	4.07	16.40	4.09	16.80	4.13	17.30	4.17
	35	12.30	3.00	14.60	3.91	15.60	4.20	15.80	4.21	16.00	4.24	16.50	4.28	16.90	4.33
	37	11.90	3.20	14.20	4.17	14.80	4.34	15.10	4.37	15.30	4.39	15.70	4.44	16.20	4.48
	39	11.70	3.40	13.90	4.44	14.40	4.50	14.50	4.51	14.70	4.54	15.20	4.59	15.60	4.63
	42	11.70	3.61	13.90	4.72	14.20	4.65	14.30	4.66	14.40	4.69	15.00	4.74	15.30	4.79
44	11.70	3.81	13.90	4.99	14.00	4.80	14.00	4.80	14.20	4.85	14.80	4.90	15.00	4.94	
46	11.70	4.02	13.90	5.27	13.80	4.96	13.70	4.95	13.90	5.00	14.60	5.05	14.70	5.09	
120	10	11.50	1.54	13.70	1.87	15.90	2.23	17.10	2.41	18.20	2.59	19.60	2.74	20.00	2.63
	12	11.50	1.56	13.70	1.91	15.90	2.27	17.00	2.45	18.20	2.64	19.30	2.73	19.70	2.61
	14	11.50	1.59	13.70	1.95	15.90	2.32	17.00	2.50	18.10	2.69	19.00	2.71	19.50	2.73
	16	11.40	1.62	13.70	1.98	15.90	2.36	17.00	2.56	18.10	2.76	18.70	2.85	19.10	2.87
	18	11.40	1.66	13.70	2.03	15.90	2.44	17.00	2.70	18.10	2.97	18.50	2.99	18.90	3.02
	20	11.40	1.68	13.60	2.10	15.90	2.62	17.00	2.91	17.80	3.11	18.20	3.14	18.60	3.16
	21	11.40	1.70	13.60	2.18	15.80	2.72	17.00	3.02	17.70	3.19	18.10	3.21	18.50	3.24
	23	11.40	1.82	13.60	2.33	15.80	2.91	16.90	3.23	17.30	3.33	17.80	3.36	18.20	3.39
	25	11.40	1.94	13.60	2.50	15.80	3.13	16.90	3.46	17.10	3.48	17.50	3.50	17.90	3.54
	27	11.40	2.08	13.60	2.68	15.80	3.34	16.60	3.61	16.80	3.62	17.30	3.65	17.70	3.68
	29	11.40	2.21	13.60	2.86	15.80	3.57	16.40	3.75	16.60	3.77	17.00	3.80	17.40	3.84
	31	11.40	2.36	13.60	3.04	15.80	3.82	16.10	3.90	16.30	3.91	16.80	3.95	17.20	3.98
	33	11.30	2.51	13.50	3.25	15.70	4.03	15.90	4.04	16.10	4.06	16.50	4.10	16.90	4.14
	35	11.30	2.68	13.50	3.46	15.30	4.17	15.50	4.19	15.80	4.21	16.20	4.25	16.60	4.29
	37	11.00	2.85	13.10	3.69	14.70	4.32	14.80	4.34	15.00	4.36	15.40	4.40	15.80	4.44
	39	10.70	3.03	12.80	3.93	14.10	4.47	14.40	4.49	14.50	4.51	14.90	4.56	15.30	4.60
	42	10.70	3.21	12.80	4.17	13.80	4.62	14.20	4.63	14.40	4.67	14.70	4.71	15.10	4.75
44	10.70	3.39	12.80	4.41	13.50	4.78	14.00	4.78	14.20	4.82	14.50	4.86	14.90	4.91	
46	10.70	3.56	12.80	4.65	13.20	4.93	13.80	4.92	14.00	4.97	14.40	5.02	14.70	5.06	
110	10	10.60	1.39	12.60	1.70	14.60	2.02	15.60	2.18	16.70	2.34	18.70	2.68	19.60	2.73
	12	10.60	1.42	12.60	1.73	14.60	2.05	15.60	2.22	16.60	2.39	18.70	2.73	19.40	2.71
	14	10.50	1.44	12.60	1.76	14.60	2.09	15.60	2.27	16.60	2.44	18.60	2.78	19.00	2.71
	16	10.50	1.47	12.60	1.80	14.60	2.14	15.60	2.31	16.60	2.48	18.40	2.83	18.80	2.86
	18	10.50	1.50	12.50	1.83	14.60	2.18	15.60	2.37	16.60	2.61	18.20	2.97	18.50	3.00
	20	10.50	1.53	12.50	1.87	14.50	2.31	15.60	2.55	16.60	2.80	17.90	3.12	18.30	3.15
	21	10.50	1.55	12.50	1.92	14.50	2.38	15.50	2.64	16.60	2.91	17.80	3.19	18.20	3.21
	23	10.50	1.62	12.50	2.06	14.50	2.56	15.50	2.83	16.50	3.12	17.40	3.33	17.80	3.36
	25	10.50	1.73	12.50	2.21	14.50	2.74	15.50	3.03	16.50	3.34	17.20	3.48	17.60	3.51
	27	10.50	1.84	12.50	2.35	14.50	2.93	15.50	3.25	16.50	3.57	16.90	3.63	17.30	3.66
	29	10.50	1.97	12.50	2.51	14.50	3.14	15.50	3.47	16.30	3.74	16.70	3.78	17.10	3.80
	31	10.40	2.09	12.50	2.68	14.50	3.34	15.50	3.71	16.10	3.89	16.40	3.92	16.80	3.96
	33	10.40	2.22	12.40	2.86	14.40	3.57	15.50	3.96	15.80	4.03	16.20	4.07	16.60	4.10
	35	10.40	2.37	12.40	3.04	14.40	3.81	15.30	4.17	15.50	4.19	15.80	4.22	16.20	4.26
	37	10.10	2.51	12.00	3.24	14.00	4.06	14.60	4.32	14.70	4.33	15.10	4.37	15.50	4.41
	39	9.90	2.68	11.80	3.45	13.70	4.33	14.10	4.46	14.30	4.48	14.60	4.52	14.90	4.56
	42	9.90	2.84	11.80	3.67	13.70	4.59	13.90	4.61	14.10	4.62	14.40	4.68	14.60	4.70
44	9.90	3.00	11.80	3.88	13.70	4.86	13.70	4.75	13.90	4.77	14.30	4.83	14.40	4.85	
46	9.90	3.16	11.80	4.09	13.70	5.12	13.50	4.90	13.70	4.92	14.10	4.98	14.10	4.99	
100	10	9.60	1.26	11.50	1.52	13.30	1.80	14.20	1.95	15.10	2.10	17.00	2.40	18.90	2.70
	12	9.60	1.28	11.50	1.56	13.30	1.84	14.20	1.99	15.10	2.14	16.90	2.44	18.90	2.75
	14	9.60	1.30	11.50	1.58	13.30	1.87	14.20	2.03	15.10	2.18	16.90	2.49	18.70	2.79
	16	9.60	1.32	11.40	1.62	13.30	1.91	14.20	2.07	15.10	2.22	16.90	2.54	18.40	2.83
	18	9.60	1.35	11.40	1.64	13.20	1.95	14.20	2.11	15.10	2.27	16.90	2.68	18.20	2.97
	20	9.50	1.38	11.40	1.68	13.20	2.01	14.10	2.21	15.10	2.43	16.90	2.89	17.90	3.12
	21	9.50	1.39	11.40	1.69	13.20	2.08	14.10	2.29	15.00	2.51	16.90	2.99	17.80	3.20
	23	9.50	1.43	11.40	1.80	13.20	2.23	14.10	2.45	15.00	2.70	16.80	3.21	17.50	3.34
	25	9.50	1.52	11.40	1.93	13.20	2.38	14.10	2.63	15.00	2.89	16.80	3.44	17.20	3.49
	27	9.50	1.62	11.40	2.06	13.20	2.55	14.10	2.81	15.00	3.09	16.60	3.61	17.00	3.63
	29	9.50	1.73	11.40	2.20	13.20	2.72	14.10	3.01	15.00	3.30	16.40	3.75	16.70	3.78
	31	9.50	1.84	11.40	2.34	13.20	2.91	14.10	3.21	15.00	3.53	16.10	3.90	16.50	3.92
	33	9.50	1.96	11.30	2.49	13.10	3.09	14.00	3.42	14.90	3.77	15.90	4.04	16.20	4.08
	35	9.50	2.08	11.30	2.65	13.10	3.30	14.00	3.68	14.90	4.02	15.50	4.19	15.90	4.22
	37	9.20	2.21	11.00	2.82	12.70	3.51	13.60	3.89	14.50	4.28	14.80	4.34	15.10	4.38
	39	9.00	2.34	10.70	3.00	12.50	3.74	13.30	4.15	14.00	4.45	14.30	4.49	14.60	4.52
	42	9.00	2.48	10.70	3.18	12.50	3.97	13.30	4.40	13.80	4.62	14.00	4.63	14.40	4.67
44	9.00	2.62	10.70	3.36	12.50	4.21	13.30	4.66	13.60	4.80	13.70	4.78	14.30	4.81	
46	9.00	2.75	10.70	3.54	12.50	4.44	13.30	4.92	13.40	4.97	13.40	4.92	14.10	4.96	
90	10	8.60	1.13	10.30	1.36	12.00	1.61	12.80	1.73	13.60	1.86	15.30	2.12	17.00	2.39
	12	8.60	1.15	10.20	1.38	12.00	1.63	12.80	1.76	13.60	1.90	15.30	2.16	16.90	2.44
	14	8.60	1.16	10.20	1.41	12.00	1.67	12.80	1.80	13.60	1.93	15.30	2.21	16.90	2.49
	16	8.60	1.19	10.20	1.44	11.90	1.69	12.80	1.83	13.60	1.97	15.30	2.25	16.90	2.53
	18	8.60	1.21	10.20	1.46	11.90	1.73	12.70	1.86	13.60	2.01	15.30	2.29	16.90	2.68
	20	8.60	1.23	10.20	1.49	11.90	1.76	12.70	1.91	13.					

10. Capacity Table

Cooling

TC : Total Capacity, PI : Power Input

Combination, % (Capacity index)	Outdoor temperature (°C, DB)	Indoor temperature (°C, WB)													
		14		16		18		19		20		22		24	
		TC kW	PI kW	TC kW	PI kW	TC kW	PI kW	TC kW	PI kW	TC kW	PI kW	TC kW	PI kW	TC kW	PI kW
90	37	8.30	1.91	9.80	2.44	11.50	3.01	12.20	3.33	13.00	3.65	14.60	4.31	14.80	4.34
	39	8.10	2.03	9.60	2.58	11.20	3.21	12.00	3.54	12.70	3.89	14.00	4.45	14.30	4.49
	42	8.10	2.15	9.60	2.73	11.20	3.40	12.00	3.75	12.70	4.13	13.70	4.60	14.00	4.63
	44	8.10	2.27	9.60	2.87	11.20	3.60	12.00	3.97	12.70	4.37	13.40	4.74	13.70	4.78
	46	8.10	2.39	9.60	3.02	11.20	3.80	12.00	4.18	12.70	4.61	13.10	4.89	13.40	4.92
	10	7.70	1.00	9.20	1.20	10.70	1.40	11.40	1.51	12.10	1.62	13.60	1.85	15.00	2.09
	12	7.70	1.02	9.20	1.21	10.70	1.43	11.40	1.54	12.10	1.66	13.60	1.89	15.00	2.13
14	7.70	1.03	9.10	1.24	10.60	1.46	11.40	1.57	12.10	1.68	13.60	1.92	15.00	2.17	
16	7.70	1.05	9.10	1.27	10.60	1.49	11.30	1.60	12.00	1.72	13.60	1.97	15.00	2.21	
18	7.60	1.07	9.10	1.28	10.60	1.51	11.30	1.63	12.00	1.75	13.60	2.00	15.00	2.26	
20	7.60	1.09	9.10	1.31	10.60	1.54	11.30	1.67	12.00	1.79	13.50	2.08	15.00	2.41	
21	7.60	1.09	9.10	1.32	10.60	1.56	11.30	1.68	12.00	1.82	13.50	2.15	14.90	2.50	
23	7.60	1.12	9.10	1.34	10.60	1.63	11.30	1.79	12.00	1.95	13.50	2.30	14.90	2.68	
25	7.60	1.15	9.10	1.44	10.60	1.74	11.30	1.91	12.00	2.09	13.50	2.46	14.90	2.87	
27	7.60	1.22	9.10	1.53	10.60	1.86	11.30	2.04	12.00	2.23	13.50	2.63	14.90	3.07	
29	7.60	1.30	9.10	1.62	10.60	1.98	11.30	2.18	12.00	2.38	13.50	2.81	14.90	3.28	
31	7.60	1.38	9.10	1.73	10.50	2.11	11.20	2.32	12.00	2.54	13.50	3.00	14.90	3.50	
33	7.60	1.47	9.10	1.84	10.50	2.25	11.20	2.47	11.90	2.70	13.40	3.20	14.80	3.74	
35	7.60	1.56	9.00	1.95	10.50	2.39	11.20	2.63	11.90	2.88	13.40	3.41	14.80	3.99	
37	7.30	1.65	8.80	2.07	10.20	2.55	10.90	2.80	11.50	3.06	13.00	3.63	14.40	4.26	
39	7.20	1.75	8.60	2.20	10.00	2.70	10.60	2.97	11.30	3.27	12.70	3.87	14.00	4.45	
42	7.20	1.85	8.60	2.33	10.00	2.86	10.60	3.15	11.30	3.47	12.70	4.11	13.90	4.65	
44	7.20	1.96	8.60	2.45	10.00	3.01	10.60	3.33	11.30	3.68	12.70	4.35	13.80	4.85	
46	7.20	2.06	8.60	2.58	10.00	3.16	10.60	3.51	11.30	3.88	12.70	4.59	13.70	5.04	
10	6.70	0.88	8.00	1.04	9.30	1.21	10.00	1.31	10.60	1.40	11.90	1.59	13.20	1.79	
12	6.70	0.89	8.00	1.06	9.30	1.24	9.90	1.33	10.60	1.43	11.90	1.62	13.20	1.82	
14	6.70	0.91	8.00	1.08	9.30	1.26	9.90	1.36	10.50	1.45	11.90	1.65	13.20	1.85	
16	6.70	0.92	8.00	1.09	9.30	1.28	9.90	1.38	10.50	1.48	11.80	1.68	13.20	1.90	
18	6.70	0.93	8.00	1.12	9.30	1.31	9.90	1.40	10.50	1.50	11.80	1.72	13.10	1.93	
20	6.70	0.95	8.00	1.14	9.30	1.33	9.90	1.44	10.50	1.54	11.80	1.75	13.10	1.98	
21	6.70	0.96	8.00	1.15	9.20	1.34	9.90	1.44	10.50	1.56	11.80	1.78	13.10	2.06	
23	6.70	0.97	8.00	1.17	9.20	1.37	9.90	1.50	10.50	1.62	11.80	1.91	13.10	2.21	
25	6.70	0.99	8.00	1.21	9.20	1.46	9.90	1.60	10.50	1.74	11.80	2.03	13.10	2.36	
27	6.70	1.05	7.90	1.29	9.20	1.56	9.90	1.70	10.50	1.85	11.80	2.17	13.10	2.52	
29	6.60	1.11	7.90	1.38	9.20	1.66	9.90	1.81	10.50	1.97	11.80	2.32	13.10	2.69	
31	6.60	1.18	7.90	1.46	9.20	1.77	9.80	1.93	10.40	2.10	11.80	2.47	13.10	2.87	
33	6.60	1.26	7.90	1.55	9.20	1.88	9.80	2.05	10.40	2.24	11.70	2.63	13.00	3.06	
35	6.60	1.32	7.90	1.64	9.20	1.99	9.80	2.18	10.40	2.38	11.70	2.80	13.00	3.26	
37	6.40	1.40	7.70	1.74	8.90	2.12	9.50	2.32	10.10	2.53	11.40	2.98	12.60	3.47	
39	6.30	1.49	7.50	1.85	8.70	2.25	9.30	2.46	9.90	2.69	11.10	3.17	12.40	3.70	
42	6.30	1.57	7.50	1.95	8.70	2.38	9.30	2.61	9.90	2.86	11.10	3.36	12.40	3.93	
44	6.30	1.66	7.50	2.05	8.70	2.50	9.30	2.75	9.90	3.02	11.10	3.55	12.40	4.16	
46	6.30	1.74	7.50	2.15	8.70	2.63	9.30	2.90	9.90	3.18	11.10	3.74	12.40	4.39	
10	5.80	0.76	6.90	0.90	8.00	1.03	8.50	1.11	9.10	1.19	10.20	1.34	11.30	1.50	
12	5.80	0.78	6.90	0.91	8.00	1.05	8.50	1.13	9.10	1.21	10.10	1.37	11.30	1.53	
14	5.70	0.79	6.90	0.92	8.00	1.08	8.50	1.15	9.10	1.23	10.10	1.39	11.20	1.56	
16	5.70	0.79	6.80	0.94	7.90	1.09	8.50	1.17	9.10	1.25	10.10	1.42	11.20	1.59	
18	5.70	0.81	6.80	0.96	7.90	1.11	8.50	1.19	9.10	1.27	10.10	1.44	11.20	1.62	
20	5.70	0.82	6.80	0.97	7.90	1.13	8.50	1.21	9.00	1.30	10.10	1.47	11.20	1.65	
21	5.70	0.83	6.80	0.98	7.90	1.14	8.50	1.22	9.00	1.31	10.10	1.49	11.20	1.67	
23	5.70	0.85	6.80	1.00	7.90	1.16	8.50	1.25	9.00	1.33	10.10	1.55	11.20	1.78	
25	5.70	0.85	6.80	1.02	7.90	1.21	8.50	1.31	9.00	1.42	10.10	1.65	11.20	1.90	
27	5.70	0.89	6.80	1.08	7.90	1.28	8.50	1.39	9.00	1.51	10.10	1.76	11.20	2.03	
29	5.70	0.94	6.80	1.15	7.90	1.37	8.40	1.49	9.00	1.61	10.10	1.87	11.20	2.15	
31	5.70	1.00	6.80	1.21	7.90	1.45	8.40	1.58	9.00	1.71	10.00	1.99	11.10	2.30	
33	5.70	1.05	6.80	1.28	7.90	1.54	8.40	1.68	9.00	1.82	10.00	2.12	11.10	2.44	
35	5.70	1.11	6.80	1.36	7.90	1.63	8.40	1.78	9.00	1.93	10.00	2.26	11.10	2.61	
37	5.50	1.18	6.60	1.44	7.60	1.74	8.20	1.89	8.70	2.05	9.70	2.40	10.80	2.77	
39	5.40	1.25	6.40	1.52	7.50	1.84	8.00	2.00	8.50	2.18	9.50	2.55	10.60	2.95	
42	5.40	1.32	6.40	1.60	7.50	1.94	8.00	2.11	8.50	2.31	9.50	2.69	10.60	3.13	
44	5.40	1.38	6.40	1.68	7.50	2.04	8.00	2.22	8.50	2.44	9.50	2.84	10.60	3.31	
46	5.40	1.45	6.40	1.75	7.50	2.15	8.00	2.33	8.50	2.56	9.50	2.98	10.60	3.49	
10	4.80	0.66	5.70	0.76	6.60	0.87	7.10	0.92	7.60	0.98	8.50	1.11	9.40	1.23	
12	4.80	0.67	5.70	0.77	6.60	0.88	7.10	0.94	7.60	1.00	8.50	1.13	9.40	1.26	
14	4.80	0.68	5.70	0.79	6.60	0.90	7.10	0.96	7.60	1.02	8.50	1.15	9.40	1.27	
16	4.80	0.68	5.70	0.79	6.60	0.91	7.10	0.97	7.60	1.03	8.50	1.16	9.40	1.30	
18	4.80	0.69	5.70	0.80	6.60	0.92	7.10	0.99	7.50	1.05	8.50	1.19	9.40	1.32	
20	4.80	0.70	5.70	0.82	6.60	0.94	7.10	1.01	7.50	1.07	8.50	1.21	9.40	1.35	
21	4.80	0.71	5.70	0.83	6.60	0.95	7.10	1.02	7.50	1.08	8.50	1.22	9.40	1.36	
23	4.80	0.72	5.70	0.84	6.60	0.97	7.10	1.03	7.50	1.10	8.40	1.24	9.40	1.39	
25	4.80	0.73	5.70	0.85	6.60	0.98	7.10	1.05	7.50	1.14	8.40	1.31	9.30	1.49	
27	4.80	0.74	5.70	0.88	6.60	1.03	7.00	1.12	7.50	1.21	8.40	1.38	9.30	1.58	
29	4.70	0.79	5.70	0.93	6.60	1.10	7.00	1.19	7.50	1.28	8.40	1.48	9.30	1.68	
31	4.70	0.83	5.70	0.99	6.60	1.17	7.00	1.27	7.50	1.36	8.40	1.57	9.30	1.80	
33	4.70	0.87	5.70	1.05	6.60	1.24	7.00	1.34	7.50	1.44	8.40	1.67	9.30	1.91	
35	4.70	0.92	5.60	1.11	6.50	1.31	7.00	1.42	7.50	1.53	8.40	1.77	9.30	2.03	
37	4.60	0.97	5.50	1.17	6.30	1.38	6.80	1.50	7.20	1.62	8.10	1.88	9.00	2.15	
39	4.50	1.03	5.40	1.24	6.20	1.47	6.70	1.59	7.10	1.72	8.00	1.99	8.80	2.28	
42	4.50	1.08	5.40	1.31	6.20	1.56	6.70	1.68	7.10	1.81	8.00	2.10	8.80	2.41	
44	4.50	1.13	5.40	1.38	6.20	1.64	6.70	1.76	7.10	1.91	8.00	2.21	8.80	2.54	
46	4.50	1.18	5.40	1.44	6.20	1.73	6.70	1.85	7.10	2.00	8.00	2.33	8.80	2.67	

NOTE

- Capacity table may be subject to change without prior notice.
- Capacity table comply with EN14511.
- Cooling capacities are based on;
 - Indoor temperature : 27°C DB, 19°C WB
 - Outdoor temperature : 35°C DB, 24°C WB, Equivalent refrigerant piping : 7.5m, Level differences : 0m
- Heating capacities are based on;
 - Indoor temperature : 20°C DB, 15°C WB
 - Outdoor temperature : 7°C DB, 6°C WB, Equivalent refrigerant piping : 7.5m, Level differences : 0m

10. Capacity Table

Heating

TC : Total Capacity, PI : Power Input

Combination, % (Capacity index)	Outdoor temperature (°C)		Indoor temperature (°C, DB)									
			16		18		20		22		24	
	DB	WB	TC kW	PI kW	TC kW	PI kW	TC kW	PI kW	TC kW	PI kW	TC kW	PI kW
130	15	14	22.90	4.55	22.80	4.63	21.40	4.29	20.10	3.95	18.60	3.63
	13	12	22.20	4.50	22.20	4.59	21.40	4.45	20.10	4.10	18.60	3.76
	11	10	21.50	4.45	21.40	4.54	21.40	4.62	20.10	4.26	18.60	3.91
	9	8	20.90	4.39	20.80	4.49	20.80	4.58	20.10	4.42	18.60	4.06
	7	6	20.20	4.38	20.20	4.48	20.20	4.58	20.10	4.65	18.60	4.26
	5	4	19.60	4.36	19.60	4.47	19.50	4.57	19.50	4.67	18.60	4.48
	3	2	19.00	4.30	18.90	4.40	18.90	4.50	18.90	4.62	18.60	4.67
	0	-1	17.90	4.18	17.90	4.30	17.80	4.41	17.80	4.52	17.80	4.63
	-3	-4	16.90	4.06	16.90	4.18	16.90	4.30	16.80	4.41	16.80	4.53
	-5	-6	16.30	4.17	16.30	4.30	16.20	4.42	16.20	4.56	16.20	4.69
	-7	-8	15.70	4.06	15.60	4.20	15.60	4.33	15.50	4.47	15.50	4.60
	-10	-11	14.40	4.01	14.40	4.16	14.40	4.31	14.30	4.46	14.30	4.61
	-12	-13	13.80	3.87	13.70	4.03	13.70	4.18	13.70	4.35	13.60	4.50
	-15	-16	13.10	3.71	13.10	3.88	13.00	4.05	13.00	4.21	13.00	4.38
	-17	-18	12.50	3.44	12.40	3.61	12.40	3.79	12.30	3.96	12.30	4.13
	-20	-21	11.40	3.16	11.30	3.34	11.30	3.53	11.30	3.72	11.20	3.91
120	15	14	22.40	4.51	21.00	4.20	19.80	3.89	18.50	3.60	17.20	3.30
	13	12	22.20	4.62	21.00	4.35	19.80	4.03	18.50	3.72	17.20	3.42
	11	10	21.40	4.57	21.00	4.52	19.80	4.19	18.50	3.86	17.20	3.55
	9	8	20.80	4.52	20.80	4.61	19.80	4.35	18.50	4.01	17.20	3.68
	7	6	20.20	4.51	20.10	4.61	19.80	4.58	18.50	4.22	17.20	3.86
	5	4	19.60	4.50	19.50	4.60	19.50	4.69	18.50	4.43	17.20	4.06
	3	2	18.90	4.44	18.90	4.54	18.90	4.63	18.50	4.62	17.20	4.23
	0	-1	17.90	4.33	17.80	4.44	17.80	4.54	17.80	4.64	17.20	4.53
	-3	-4	16.90	4.22	16.90	4.33	16.80	4.44	16.80	4.55	16.80	4.65
	-5	-6	16.30	4.34	16.20	4.46	16.20	4.58	16.20	4.70	16.10	4.82
	-7	-8	15.60	4.25	15.60	4.37	15.50	4.49	15.50	4.62	15.50	4.75
	-10	-11	14.40	4.21	14.30	4.35	14.30	4.49	14.30	4.63	14.20	4.78
	-12	-13	13.70	4.08	13.70	4.22	13.70	4.38	13.60	4.52	13.60	4.67
	-15	-16	13.10	3.94	13.00	4.09	13.00	4.24	13.00	4.40	12.90	4.56
	-17	-18	12.40	3.67	12.40	3.83	12.30	3.99	12.30	4.15	12.30	4.31
	-20	-21	11.30	3.40	11.30	3.58	11.30	3.75	11.20	3.93	11.20	4.10
110	15	14	20.50	4.06	19.30	3.78	18.10	3.50	17.00	3.25	15.80	2.99
	13	12	20.50	4.20	19.30	3.91	18.10	3.63	17.00	3.36	15.80	3.09
	11	10	20.50	4.37	19.30	4.06	18.10	3.77	17.00	3.48	15.80	3.20
	9	8	20.50	4.54	19.30	4.22	18.10	3.91	17.00	3.61	15.80	3.32
	7	6	20.10	4.64	19.30	4.44	18.10	4.11	17.00	3.79	15.80	3.48
	5	4	19.50	4.63	19.30	4.67	18.10	4.32	17.00	3.98	15.80	3.66
	3	2	18.90	4.58	18.80	4.67	18.10	4.50	17.00	4.16	15.80	3.81
	0	-1	17.80	4.48	17.80	4.58	17.80	4.67	17.00	4.44	15.80	4.07
	-3	-4	16.80	4.38	16.80	4.47	16.80	4.58	16.70	4.68	15.80	4.38
	-5	-6	16.20	4.52	16.20	4.63	16.10	4.74	16.10	4.85	15.80	4.83
	-7	-8	15.60	4.42	15.50	4.54	15.50	4.66	15.50	4.77	15.40	4.89
	-10	-11	14.30	4.42	14.30	4.54	14.30	4.67	14.20	4.81	14.20	4.93
	-12	-13	13.70	4.30	13.60	4.43	13.60	4.56	13.60	4.70	13.60	4.84
	-15	-16	13.00	4.16	13.00	4.31	13.00	4.45	12.90	4.59	12.90	4.73
	-17	-18	12.40	3.91	12.30	4.05	12.30	4.20	12.30	4.35	12.20	4.50
	-20	-21	11.30	3.66	11.20	3.82	11.20	3.98	11.20	4.14	11.10	4.30
100	15	14	18.60	3.52	17.50	3.29	16.20	3.05	15.50	2.83	14.30	2.61
	13	12	18.60	3.64	17.50	3.39	16.20	3.16	15.50	2.92	14.30	2.70
	11	10	18.60	3.79	17.50	3.53	16.20	3.28	15.50	3.03	14.30	2.80
	9	8	18.60	3.93	17.50	3.66	16.20	3.39	15.50	3.14	14.30	2.89
	7	6	18.60	4.12	17.50	3.84	16.00	3.61	15.50	3.29	14.30	3.03
	5	4	18.60	4.34	17.50	4.04	16.00	3.75	15.50	3.46	14.30	3.18
	3	2	18.60	4.53	17.50	4.21	16.00	3.90	15.50	3.60	14.30	3.31
	0	-1	17.80	4.51	17.50	4.50	16.00	4.17	15.50	3.85	14.30	3.53
	-3	-4	16.80	4.42	16.80	4.50	16.00	4.49	15.50	4.14	14.30	3.79
	-5	-6	16.20	4.56	16.10	4.66	15.80	4.77	15.50	4.56	14.30	4.18
	-7	-8	15.50	4.49	15.50	4.59	15.10	4.69	15.40	4.79	14.30	4.41
	-10	-11	14.30	4.50	14.30	4.61	14.10	4.73	14.20	4.84	14.20	4.96
	-12	-13	13.60	4.39	13.60	4.51	13.50	4.63	13.50	4.75	13.50	4.87
	-15	-16	13.00	4.27	12.90	4.40	12.80	4.53	12.90	4.65	12.90	4.78
	-17	-18	12.30	4.03	12.30	4.16	12.10	4.29	12.20	4.41	12.20	4.55
	-20	-21	11.20	3.82	11.20	3.95	11.20	4.10	11.10	4.23	11.10	4.38
90	15	14	16.80	3.19	15.80	2.98	14.80	2.78	13.90	2.58	12.90	2.39
	13	12	16.80	3.30	15.80	3.08	14.80	2.87	13.90	2.67	12.90	2.47
	11	10	16.80	3.43	15.80	3.20	14.80	2.98	13.90	2.76	12.90	2.55
	9	8	16.80	3.55	15.80	3.31	14.80	3.08	13.90	2.86	12.90	2.64
	7	6	16.80	3.73	15.80	3.48	14.80	3.23	13.90	2.99	12.90	2.76
	5	4	16.80	3.92	15.80	3.65	14.80	3.39	13.90	3.15	12.90	2.89
	3	2	16.80	4.08	15.80	3.80	14.80	3.53	13.90	3.27	12.90	3.01
	0	-1	16.80	4.36	15.80	4.06	14.80	3.77	13.90	3.48	12.90	3.20
	-3	-4	16.70	4.70	15.80	4.37	14.80	4.05	13.90	3.74	12.90	3.44
	-5	-6	16.10	4.87	15.80	4.83	14.80	4.46	13.90	4.12	12.90	3.78
	-7	-8	15.50	4.80	15.40	4.89	14.80	4.72	13.90	4.34	12.90	3.98
	-10	-11	14.20	4.83	14.20	4.93	14.20	5.03	13.90	4.97	12.90	4.55
	-12	-13	13.60	4.72	13.60	4.84	13.50	4.95	13.50	5.06	12.90	4.84
	-15	-16	12.90	4.62	12.90	4.73	12.90	4.85	12.80	4.97	12.80	5.08
	-17	-18	12.30	4.38	12.20	4.50	12.20	4.61	12.20	4.73	12.20	4.85
	-20	-21	11.20	4.17	11.10	4.30	11.10	4.43	11.10	4.56	11.10	4.69
80	15	14	14.80	2.79	14.00	2.61	13.20	2.44	12.40	2.27	11.50	2.10
	13	12	14.80	2.88	14.00	2.70	13.20	2.51	12.40	2.34	11.50	2.17
	11	10	14.80	2.99	14.00	2.80	13.20	2.61	12.40	2.42	11.50	2.25
	9	8	14.80	3.09	14.00	2.89	13.20	2.70	12.40	2.50	11.50	2.32
	7	6	14.80	3.24	14.00	3.03	13.20	2.83	12.40	2.62	11.50	2.43
	5	4	14.80	3.41	14.00	3.18	13.20	2.96	12.40	2.74	11.50	2.54
	3	2	14.80	3.55	14.00	3.30	13.20	3.08	12.40	2.86	11.50	2.64
	0	-1	14.80	3.78	14.00	3.53	13.20	3.28	12.40	3.03	11.50	2.80
	-3	-4	14.80	4.06	14.00	3.79	13.20	3.52	12.40	3.25	11.50	3.00
	-5	-6	14.80	4.48	14.00	4.18	13.20	3.87	12.40	3.58	11.50	3.29

10. Capacity Table

Heating

TC : Total Capacity, PI : Power Input

Combination, % (Capacity Index)	Outdoor temperature (°C)		Indoor temperature (°C, DB)									
			16		18		20		22		24	
	DB	WB	TC kW	PI kW	TC kW	PI kW	TC kW	PI kW	TC kW	PI kW	TC kW	PI kW
80	-7	-8	14.80	4.73	14.00	4.40	13.20	4.08	12.40	3.76	11.50	3.47
	-10	-11	14.20	5.03	14.00	5.04	13.20	4.66	12.40	4.31	11.50	3.95
	-12	-13	13.50	4.94	13.50	5.04	13.20	4.96	12.40	4.57	11.50	4.19
	-15	-16	12.90	4.85	12.80	4.95	12.80	5.05	12.40	4.88	11.50	4.47
	-17	-18	12.20	4.60	12.20	4.71	12.20	4.82	12.10	4.92	11.50	4.65
	-20	-21	11.10	4.43	11.10	4.54	11.10	4.65	11.10	4.77	11.00	4.89
	-15	14	13.00	2.40	12.30	2.26	11.50	2.11	10.80	1.97	10.10	1.83
13	12	13.00	2.49	12.30	2.33	11.50	2.18	10.80	2.04	10.10	1.89	
11	10	13.00	2.57	12.30	2.41	11.50	2.26	10.80	2.10	10.10	1.95	
9	8	13.00	2.66	12.30	2.50	11.50	2.33	10.80	2.17	10.10	2.01	
7	6	13.00	2.78	12.30	2.60	11.50	2.44	10.80	2.27	10.10	2.10	
5	4	13.00	2.92	12.30	2.73	11.50	2.55	10.80	2.37	10.10	2.20	
3	2	13.00	3.03	12.30	2.84	11.50	2.65	10.80	2.46	10.10	2.27	
0	-1	13.00	3.23	12.30	3.02	11.50	2.82	10.80	2.61	10.10	2.42	
-3	-4	13.00	3.46	12.30	3.24	11.50	3.01	10.80	2.79	10.10	2.58	
-5	-6	13.00	3.81	12.30	3.56	11.50	3.31	10.80	3.07	10.10	2.83	
-7	-8	13.00	4.02	12.30	3.75	11.50	3.48	10.80	3.22	10.10	2.97	
-10	-11	13.00	4.59	12.30	4.28	11.50	3.97	10.80	3.66	10.10	3.38	
-12	-13	13.00	4.89	12.30	4.54	11.50	4.21	10.80	3.89	10.10	3.58	
-15	-16	12.80	5.07	12.30	4.85	11.50	4.49	10.80	4.14	10.10	3.81	
-17	-18	12.20	4.84	12.10	4.93	11.50	4.67	10.80	4.31	10.10	3.95	
-20	-21	11.10	4.67	11.10	4.78	11.00	4.88	10.80	4.81	10.10	4.41	
15	14	11.10	2.05	10.50	1.92	9.90	1.81	9.30	1.69	8.60	1.58	
13	12	11.10	2.10	10.50	1.98	9.90	1.85	9.30	1.73	8.60	1.61	
11	10	11.10	2.17	10.50	2.05	9.90	1.92	9.30	1.79	8.60	1.67	
9	8	11.10	2.25	10.50	2.11	9.90	1.98	9.30	1.84	8.60	1.72	
7	6	11.10	2.34	10.50	2.21	9.90	2.07	9.30	1.93	8.60	1.80	
5	4	11.10	2.46	10.50	2.31	9.90	2.16	9.30	2.01	8.60	1.87	
3	2	11.10	2.56	10.50	2.40	9.90	2.24	9.30	2.09	8.60	1.94	
0	-1	11.10	2.71	10.50	2.54	9.90	2.38	9.30	2.21	8.60	2.05	
-3	-4	11.10	2.90	10.50	2.71	9.90	2.54	9.30	2.36	8.60	2.18	
-5	-6	11.10	3.18	10.50	2.98	9.90	2.78	9.30	2.59	8.60	2.39	
-7	-8	11.10	3.35	10.50	3.13	9.90	2.92	9.30	2.71	8.60	2.51	
-10	-11	11.10	3.82	10.50	3.56	9.90	3.32	9.30	3.07	8.60	2.84	
-12	-13	11.10	4.05	10.50	3.78	9.90	3.51	9.30	3.26	8.60	3.00	
-15	-16	11.10	4.31	10.50	4.02	9.90	3.73	9.30	3.45	8.60	3.18	
-17	-18	11.10	4.49	10.50	4.18	9.90	3.87	9.30	3.58	8.60	3.29	
-20	-21	11.00	4.93	10.50	4.66	9.90	4.32	9.30	3.98	8.60	3.66	
15	14	9.30	1.70	8.80	1.60	8.20	1.50	7.70	1.41	7.20	1.32	
13	12	9.30	1.74	8.80	1.64	8.20	1.55	7.70	1.45	7.20	1.36	
11	10	9.30	1.80	8.80	1.70	8.20	1.60	7.70	1.50	7.20	1.40	
9	8	9.30	1.85	8.80	1.75	8.20	1.64	7.70	1.54	7.20	1.44	
7	6	9.30	1.94	8.80	1.83	8.20	1.71	7.70	1.60	7.20	1.50	
5	4	9.30	2.02	8.80	1.91	8.20	1.79	7.70	1.68	7.20	1.56	
3	2	9.30	2.10	8.80	1.98	8.20	1.85	7.70	1.73	7.20	1.62	
0	-1	9.30	2.22	8.80	2.09	8.20	1.96	7.70	1.83	7.20	1.70	
-3	-4	9.30	2.37	8.80	2.23	8.20	2.08	7.70	1.95	7.20	1.81	
-5	-6	9.30	2.60	8.80	2.44	8.20	2.28	7.70	2.12	7.20	1.98	
-7	-8	9.30	2.72	8.80	2.56	8.20	2.39	7.70	2.22	7.20	2.06	
-10	-11	9.30	3.09	8.80	2.90	8.20	2.70	7.70	2.51	7.20	2.33	
-12	-13	9.30	3.27	8.80	3.06	8.20	2.86	7.70	2.65	7.20	2.46	
-15	-16	9.30	3.47	8.80	3.24	8.20	3.02	7.70	2.81	7.20	2.60	
-17	-18	9.30	3.60	8.80	3.36	8.20	3.14	7.70	2.91	7.20	2.69	
-20	-21	9.30	4.01	8.80	3.74	8.20	3.47	7.70	3.22	7.20	2.97	

NOTE

- Capacity table may be subject to change without prior notice.
- Capacity table comply with EN14511.
- Cooling capacities are based on;
 - Indoor temperature : 27°C DB, 19°C WB
 - Outdoor temperature : 35°C DB, 24°C WB, Equivalent refrigerant piping : 7.5m, Level differences : 0m
- Heating capacities are based on;
 - Indoor temperature : 20°C DB, 15°C WB
 - Outdoor temperature : 7°C DB, 6°C WB, Equivalent refrigerant piping : 7.5m, Level differences : 0m

10. Capacity Table

AM060FXMDEH/EU

Cooling

TC : Total Capacity, PI : Power Input

Combination, % (Capacity index)	Outdoor temperature (°C, DB)	Indoor temperature (°C, WB)													
		14		16		18		19		20		22		24	
		TC kW	PI kW	TC kW	PI kW	TC kW	PI kW	TC kW	PI kW	TC kW	PI kW	TC kW	PI kW	TC kW	PI kW
130	10	13.80	1.98	16.40	2.43	19.10	2.89	20.50	3.12	20.70	3.06	21.20	2.93	21.70	2.79
	12	13.80	2.02	16.40	2.47	19.10	2.94	20.20	3.10	20.40	3.04	20.90	2.91	21.40	2.86
	14	13.80	2.06	16.40	2.52	19.00	3.00	19.90	3.09	20.20	3.02	20.70	3.00	21.20	3.02
	16	13.80	2.10	16.40	2.58	19.00	3.06	19.60	3.11	19.80	3.13	20.30	3.16	20.90	3.19
	18	13.80	2.14	16.40	2.62	19.00	3.26	19.30	3.28	19.50	3.29	20.00	3.32	20.50	3.35
	20	13.70	2.18	16.40	2.79	18.80	3.42	19.00	3.43	19.30	3.45	19.80	3.49	20.30	3.52
	21	13.70	2.25	16.40	2.89	18.70	3.50	18.90	3.52	19.20	3.53	19.60	3.56	20.10	3.60
	23	13.70	2.40	16.30	3.10	18.40	3.66	18.60	3.68	18.90	3.70	19.40	3.73	19.90	3.76
	25	13.70	2.57	16.30	3.32	18.00	3.82	18.30	3.84	18.50	3.85	19.00	3.89	19.50	3.93
	27	13.70	2.75	16.30	3.55	17.80	3.98	18.00	4.00	18.30	4.02	18.80	4.05	19.20	4.10
	29	13.70	2.93	16.30	3.80	17.50	4.14	17.80	4.16	18.00	4.18	18.50	4.23	19.00	4.26
	31	13.70	3.12	16.30	4.05	17.30	4.30	17.50	4.32	17.70	4.35	18.20	4.39	18.70	4.44
	33	13.60	3.33	16.30	4.33	17.00	4.47	17.20	4.48	17.50	4.51	18.00	4.56	18.50	4.60
	35	13.60	3.54	16.10	4.57	16.60	4.63	16.90	4.65	17.10	4.68	17.60	4.73	18.10	4.78
	37	13.20	3.59	15.40	4.50	15.90	4.55	16.10	4.57	16.40	4.60	16.80	4.65	17.30	4.70
	39	12.90	3.62	14.80	4.41	15.30	4.46	15.50	4.49	15.80	4.51	16.30	4.56	16.70	4.61
42	12.90	3.83	14.50	4.56	15.00	4.61	15.20	4.64	15.50	4.67	16.10	4.72	16.50	4.77	
44	12.90	4.04	14.30	4.71	14.70	4.76	14.90	4.80	15.20	4.82	15.90	4.87	16.30	4.92	
46	12.90	4.26	14.00	4.86	14.40	4.91	14.60	4.96	14.90	4.98	15.70	5.03	16.20	5.08	
120	10	12.80	1.82	15.20	2.22	17.70	2.63	18.90	2.85	20.10	3.06	20.80	3.02	21.30	2.90
	12	12.80	1.84	15.20	2.26	17.60	2.68	18.90	2.90	20.10	3.12	20.60	3.00	21.00	2.88
	14	12.80	1.88	15.20	2.30	17.60	2.74	18.80	2.96	19.90	3.10	20.30	2.99	20.80	3.00
	16	12.80	1.92	15.20	2.35	17.60	2.79	18.80	3.01	19.50	3.11	20.00	3.14	20.40	3.17
	18	12.70	1.95	15.20	2.39	17.60	2.89	18.80	3.20	19.20	3.27	19.70	3.30	20.10	3.32
	20	12.70	1.99	15.20	2.48	17.60	3.10	18.80	3.42	19.00	3.43	19.40	3.46	19.90	3.49
	21	12.70	2.01	15.10	2.58	17.60	3.21	18.60	3.50	18.80	3.52	19.30	3.54	19.80	3.57
	23	12.70	2.15	15.10	2.76	17.50	3.44	18.40	3.65	18.60	3.67	19.00	3.71	19.50	3.73
	25	12.70	2.29	15.10	2.95	17.50	3.69	18.00	3.82	18.20	3.84	18.70	3.86	19.10	3.90
	27	12.70	2.45	15.10	3.16	17.50	3.95	17.70	3.97	18.00	3.99	18.40	4.03	18.90	4.06
	29	12.70	2.61	15.10	3.37	17.20	4.12	17.50	4.14	17.70	4.15	18.10	4.19	18.60	4.24
	31	12.70	2.79	15.10	3.60	17.00	4.27	17.20	4.30	17.40	4.32	17.90	4.36	18.30	4.40
	33	12.60	2.97	15.10	3.84	16.70	4.44	16.90	4.46	17.20	4.48	17.60	4.52	18.10	4.57
	35	12.60	3.16	15.00	4.09	16.40	4.60	16.60	4.62	16.80	4.65	17.30	4.69	17.70	4.74
	37	12.20	3.19	14.60	4.14	15.60	4.52	15.80	4.55	16.00	4.57	16.50	4.61	17.00	4.66
	39	12.00	3.22	14.30	4.18	15.00	4.43	15.30	4.45	15.50	4.48	15.90	4.52	16.30	4.57
42	12.00	3.42	14.30	4.45	14.70	4.58	15.10	4.60	15.30	4.63	15.60	4.67	16.10	4.73	
44	12.00	3.62	14.30	4.71	14.40	4.73	14.90	4.75	15.10	4.77	15.30	4.82	15.80	4.88	
46	12.00	3.81	14.30	4.97	14.20	4.87	14.70	4.90	14.90	4.92	15.00	4.96	15.50	5.04	
110	10	11.70	1.64	13.90	2.01	16.10	2.38	17.40	2.58	18.50	2.77	20.50	3.11	20.90	3.00
	12	11.70	1.68	13.90	2.05	16.10	2.43	17.30	2.62	18.50	2.82	20.20	3.10	20.60	2.99
	14	11.70	1.71	13.90	2.08	16.10	2.47	17.30	2.68	18.40	2.88	20.00	3.08	20.40	2.99
	16	11.60	1.73	13.90	2.12	16.10	2.52	17.30	2.72	18.40	2.93	19.60	3.12	20.00	3.14
	18	11.60	1.77	13.90	2.16	16.10	2.58	17.30	2.80	18.40	3.08	19.30	3.28	19.80	3.31
	20	11.60	1.81	13.80	2.21	16.10	2.72	17.30	3.01	18.40	3.31	19.10	3.44	19.50	3.47
	21	11.60	1.83	13.80	2.27	16.00	2.82	17.30	3.11	18.40	3.43	19.00	3.52	19.40	3.54
	23	11.60	1.91	13.80	2.44	16.00	3.02	17.20	3.34	18.20	3.65	18.70	3.68	19.10	3.71
	25	11.60	2.04	13.80	2.60	16.00	3.24	17.20	3.58	17.90	3.81	18.30	3.84	18.70	3.87
	27	11.60	2.17	13.80	2.79	16.00	3.46	17.20	3.84	17.70	3.97	18.10	4.00	18.50	4.04
	29	11.60	2.32	13.80	2.97	16.00	3.70	17.20	4.10	17.40	4.13	17.80	4.16	18.20	4.20
	31	11.60	2.47	13.80	3.17	16.00	3.95	16.90	4.27	17.10	4.29	17.50	4.33	18.00	4.36
	33	11.50	2.63	13.70	3.38	16.00	4.22	16.70	4.43	16.90	4.45	17.30	4.49	17.70	4.53
	35	11.50	2.79	13.70	3.60	15.90	4.50	16.30	4.59	16.50	4.61	16.90	4.66	17.30	4.69
	37	11.20	2.82	13.30	3.63	15.30	4.49	15.50	4.52	15.70	4.54	16.20	4.58	16.60	4.62
	39	10.90	2.84	13.00	3.67	14.80	4.40	15.00	4.43	15.20	4.45	15.60	4.49	16.00	4.53
42	10.90	3.02	13.00	3.89	14.60	4.55	14.80	4.58	15.00	4.59	15.30	4.64	15.70	4.68	
44	10.90	3.19	13.00	4.11	14.40	4.70	14.60	4.73	14.80	4.74	15.00	4.78	15.40	4.82	
46	10.90	3.36	13.00	4.33	14.30	4.85	14.40	4.87	14.60	4.89	14.70	4.93	15.10	4.97	
100	10	10.70	1.49	12.70	1.80	14.70	2.14	15.70	2.30	16.80	2.48	18.80	2.83	20.50	3.10
	12	10.70	1.51	12.70	1.84	14.70	2.17	15.70	2.35	16.70	2.53	18.80	2.89	20.30	3.09
	14	10.60	1.53	12.70	1.87	14.70	2.22	15.70	2.39	16.70	2.58	18.70	2.94	20.00	3.07
	16	10.60	1.56	12.70	1.90	14.70	2.26	15.70	2.44	16.70	2.62	18.70	3.00	19.60	3.12
	18	10.60	1.60	12.60	1.94	14.70	2.30	15.70	2.49	16.70	2.68	18.70	3.17	19.40	3.28
	20	10.60	1.63	12.60	1.98	14.70	2.37	15.70	2.61	16.70	2.87	18.70	3.42	19.10	3.44
	21	10.60	1.64	12.60	2.00	14.60	2.46	15.60	2.70	16.70	2.97	18.60	3.50	19.00	3.52
	23	10.60	1.68	12.60	2.13	14.60	2.63	15.60	2.90	16.60	3.19	18.20	3.65	18.70	3.68
	25	10.60	1.80	12.60	2.27	14.60	2.81	15.60	3.10	16.60	3.42	18.00	3.82	18.40	3.84
	27	10.60	1.92	12.60	2.43	14.60	3.00	15.60	3.32	16.60	3.65	17.70	3.97	18.10	4.01
	29	10.60	2.04	12.60	2.59	14.60	3.21	15.60	3.55	16.60	3.90	17.50	4.14	17.80	4.16
	31	10.50	2.17	12.60	2.77	14.60	3.42	15.60	3.79	16.60	4.16	17.20	4.29	17.60	4.33
	33	10.50	2.31	12.50	2.94	14.50	3.65	15.60	4.05	16.60	4.42	16.90	4.46	17.30	4.49
	35	10.50	2.46	12.50	3.13	14.50	3.90	15.50	4.31	16.20	4.58	16.60	4.62	16.90	4.66
	37	10.20	2.47	12.10	3.17	14.10	3.95	15.00	4.36	15.40	4.51	15.80	4.55	16.20	4.58
	39	10.00	2.49	11.90	3.19	13.80	3.98	14.70	4.40	14.90	4.41	15.20	4.45	15.60	4.50
42	10.00	2.64	11.90	3.38	13.80	4.22	14.70	4.66	14.70	4.55	14.90	4.60	15.30	4.65	
44	10.00	2.79	11.90	3.57	13.80	4.45	14.70	4.92	14.50	4.69	14.60	4.75	15.00	4.81	
46	10.00	2.93	11.90	3.76	13.80	4.69	14.70	5.19	14.40	4.83	14.40	4.90	14.70	4.96	
90	10	9.60	1.33	11.40	1.61	13.20	1.89	14.20	2.05	15.10	2.19	17.00	2.51	18.80	2.83
	12	9.50	1.35	11.40	1.63	13.20	1.93	14.20	2.08	15.10	2.24	16.90	2.56	18.80	2.88
	14	9.50	1.38	11.40	1.66	13.20	1.96	14.20	2.12	15.10	2.28	16.90	2.60	18.70	2.93
	16	9.50	1.40	11.30	1.69	13.20	2.00	14.20	2.16	15.10	2.32	16.90	2.66	18.70	3.00
	18	9.50	1.42	11.30	1.73	13.10	2.04	14.20	2.20	15.10	2.37	16.90	2.71	18.70	3.16
	20	9.50	1.45	11.30	1.75	13.10	2.08								

10. Capacity Table

Cooling

TC : Total Capacity, PI : Power Input

Combination, % (Capacity index)	Outdoor temperature (°C, DB)	Indoor temperature (°C, WB)													
		14		16		18		19		20		22		24	
		TC kW	PI kW	TC kW	PI kW	TC kW	PI kW	TC kW	PI kW	TC kW	PI kW	TC kW	PI kW	TC kW	PI kW
90	37	9.10	2.15	10.90	2.73	12.60	3.37	13.60	3.72	14.50	4.09	15.50	4.51	15.80	4.55
	39	8.90	2.16	10.60	2.74	12.40	3.40	13.30	3.76	14.20	4.13	14.90	4.42	15.20	4.45
	42	8.90	2.28	10.60	2.90	12.40	3.61	13.30	3.99	14.20	4.39	14.60	4.57	14.90	4.60
	44	8.90	2.41	10.60	3.06	12.40	3.81	13.30	4.22	14.20	4.64	14.40	4.72	14.60	4.75
	46	8.90	2.53	10.60	3.21	12.40	4.02	13.30	4.45	14.20	4.90	14.10	4.87	14.40	4.90
	10	8.50	1.18	10.20	1.42	11.80	1.66	12.60	1.79	13.40	1.92	15.00	2.19	16.70	2.47
	12	8.50	1.20	10.10	1.43	11.80	1.69	12.60	1.82	13.40	1.95	15.00	2.23	16.60	2.51
14	8.50	1.21	10.10	1.46	11.80	1.72	12.60	1.85	13.40	1.99	15.00	2.27	16.60	2.56	
16	8.50	1.24	10.10	1.49	11.70	1.75	12.60	1.89	13.40	2.03	15.00	2.32	16.60	2.61	
18	8.50	1.26	10.10	1.52	11.70	1.79	12.50	1.93	13.40	2.07	15.00	2.37	16.60	2.67	
20	8.50	1.29	10.10	1.54	11.70	1.82	12.50	1.96	13.30	2.11	15.00	2.45	16.60	2.85	
21	8.50	1.30	10.10	1.56	11.70	1.84	12.50	1.98	13.30	2.16	14.90	2.54	16.60	2.95	
23	8.40	1.31	10.10	1.59	11.70	1.93	12.50	2.11	13.30	2.30	14.90	2.72	16.50	3.16	
25	8.40	1.36	10.10	1.69	11.70	2.06	12.50	2.26	13.30	2.47	14.90	2.90	16.50	3.39	
27	8.40	1.45	10.10	1.80	11.70	2.20	12.50	2.41	13.30	2.63	14.90	3.10	16.50	3.63	
29	8.40	1.54	10.10	1.92	11.70	2.34	12.50	2.57	13.30	2.81	14.90	3.32	16.50	3.87	
31	8.40	1.63	10.00	2.04	11.70	2.49	12.50	2.74	13.30	3.00	14.90	3.54	16.50	4.14	
33	8.40	1.73	10.00	2.17	11.60	2.66	12.40	2.91	13.20	3.19	14.80	3.78	16.50	4.42	
35	8.40	1.84	10.00	2.30	11.60	2.82	12.40	3.10	13.20	3.40	14.80	4.03	16.20	4.58	
37	8.10	1.85	9.70	2.32	11.30	2.85	12.00	3.14	12.80	3.44	14.40	4.08	15.40	4.50	
39	8.00	1.86	9.50	2.33	11.00	2.88	11.80	3.16	12.50	3.47	14.10	4.12	14.90	4.41	
42	8.00	1.96	9.50	2.47	11.00	3.05	11.80	3.35	12.50	3.68	14.10	4.37	14.70	4.56	
44	8.00	2.07	9.50	2.60	11.00	3.22	11.80	3.54	12.50	3.90	14.10	4.63	14.50	4.71	
46	8.00	2.18	9.50	2.73	11.00	3.39	11.80	3.73	12.50	4.11	14.10	4.88	14.40	4.86	
10	7.40	1.04	8.90	1.23	10.30	1.43	11.10	1.54	11.80	1.65	13.20	1.88	14.60	2.12	
12	7.40	1.05	8.90	1.25	10.20	1.46	11.10	1.57	11.80	1.68	13.20	1.92	14.60	2.16	
14	7.40	1.07	8.80	1.27	10.20	1.49	11.00	1.60	11.80	1.72	13.20	1.95	14.60	2.19	
16	7.40	1.09	8.80	1.30	10.20	1.52	11.00	1.63	11.70	1.74	13.20	1.99	14.60	2.24	
18	7.40	1.10	8.80	1.31	10.20	1.54	11.00	1.66	11.70	1.78	13.10	2.03	14.60	2.28	
20	7.40	1.12	8.80	1.34	10.20	1.57	11.00	1.69	11.70	1.82	13.10	2.06	14.50	2.35	
21	7.40	1.13	8.80	1.35	10.20	1.59	11.00	1.71	11.70	1.84	13.10	2.10	14.50	2.43	
23	7.40	1.15	8.80	1.38	10.20	1.62	11.00	1.76	11.70	1.92	13.10	2.25	14.50	2.60	
25	7.40	1.18	8.80	1.43	10.20	1.73	11.00	1.88	11.70	2.05	13.10	2.40	14.50	2.79	
27	7.40	1.24	8.80	1.52	10.20	1.84	11.00	2.01	11.70	2.19	13.10	2.57	14.50	2.98	
29	7.40	1.31	8.80	1.63	10.20	1.96	11.00	2.14	11.70	2.33	13.10	2.74	14.50	3.18	
31	7.40	1.40	8.80	1.73	10.10	2.08	10.90	2.28	11.70	2.48	13.10	2.91	14.50	3.39	
33	7.30	1.48	8.80	1.83	10.10	2.22	10.90	2.43	11.60	2.64	13.00	3.10	14.40	3.62	
35	7.30	1.57	8.70	1.94	10.10	2.36	10.90	2.58	11.60	2.81	13.00	3.31	14.40	3.85	
37	7.10	1.58	8.50	1.95	9.80	2.38	10.60	2.60	11.30	2.84	12.60	3.35	14.00	3.89	
39	7.00	1.58	8.30	1.96	9.60	2.39	10.40	2.62	11.00	2.86	12.40	3.38	13.70	3.93	
42	7.00	1.66	8.30	2.08	9.60	2.53	10.40	2.78	11.00	3.03	12.40	3.58	13.70	4.17	
44	7.00	1.74	8.30	2.19	9.60	2.67	10.40	2.93	11.00	3.21	12.40	3.79	13.70	4.40	
46	7.00	1.82	8.30	2.31	9.60	2.81	10.40	3.09	11.00	3.38	12.40	3.99	13.70	4.64	
10	6.40	0.90	7.60	1.06	8.80	1.22	9.40	1.31	10.10	1.41	11.30	1.59	12.50	1.78	
12	6.40	0.91	7.60	1.08	8.80	1.24	9.40	1.33	10.00	1.42	11.30	1.62	12.50	1.81	
14	6.40	0.93	7.60	1.10	8.80	1.27	9.40	1.36	10.00	1.45	11.20	1.64	12.50	1.84	
16	6.40	0.94	7.60	1.11	8.80	1.29	9.40	1.38	10.00	1.48	11.20	1.67	12.50	1.88	
18	6.40	0.96	7.60	1.13	8.80	1.31	9.40	1.41	10.00	1.51	11.20	1.71	12.40	1.92	
20	6.30	0.97	7.60	1.15	8.80	1.33	9.40	1.43	10.00	1.53	11.20	1.73	12.40	1.95	
21	6.30	0.98	7.60	1.16	8.80	1.35	9.40	1.44	10.00	1.54	11.20	1.75	12.40	1.97	
23	6.30	1.00	7.60	1.18	8.80	1.37	9.40	1.47	10.00	1.58	11.20	1.83	12.40	2.09	
25	6.30	1.01	7.50	1.20	8.80	1.42	9.40	1.55	10.00	1.67	11.20	1.94	12.40	2.24	
27	6.30	1.05	7.50	1.27	8.80	1.52	9.40	1.64	10.00	1.78	11.20	2.07	12.40	2.39	
29	6.30	1.11	7.50	1.35	8.70	1.62	9.40	1.75	10.00	1.90	11.20	2.21	12.40	2.55	
31	6.30	1.18	7.50	1.43	8.70	1.72	9.30	1.86	9.90	2.02	11.10	2.36	12.40	2.71	
33	6.30	1.24	7.50	1.52	8.70	1.82	9.30	1.98	9.90	2.15	11.10	2.50	12.30	2.89	
35	6.30	1.31	7.50	1.61	8.70	1.93	9.30	2.10	9.90	2.28	11.10	2.67	12.30	3.08	
37	6.10	1.32	7.30	1.61	8.40	1.94	9.00	2.12	9.60	2.30	10.80	2.69	11.90	3.11	
39	6.00	1.32	7.10	1.62	8.30	1.95	8.80	2.13	9.40	2.32	10.60	2.71	11.70	3.13	
42	6.00	1.40	7.10	1.71	8.30	2.05	8.80	2.25	9.40	2.46	10.60	2.88	11.70	3.31	
44	6.00	1.47	7.10	1.80	8.30	2.16	8.80	2.38	9.40	2.60	10.60	3.04	11.70	3.49	
46	6.00	1.55	7.10	1.89	8.30	2.27	8.80	2.50	9.40	2.74	10.60	3.21	11.70	3.67	
10	5.30	0.78	6.30	0.89	7.40	1.03	7.90	1.10	8.40	1.16	9.40	1.31	10.50	1.45	
12	5.30	0.79	6.30	0.91	7.40	1.04	7.90	1.11	8.40	1.19	9.40	1.33	10.40	1.48	
14	5.30	0.79	6.30	0.92	7.30	1.06	7.90	1.13	8.40	1.21	9.40	1.35	10.40	1.51	
16	5.30	0.80	6.30	0.94	7.30	1.08	7.80	1.15	8.40	1.22	9.40	1.38	10.40	1.53	
18	5.30	0.82	6.30	0.95	7.30	1.10	7.80	1.17	8.30	1.24	9.40	1.40	10.40	1.56	
20	5.30	0.83	6.30	0.97	7.30	1.11	7.80	1.19	8.30	1.27	9.40	1.42	10.40	1.59	
21	5.30	0.84	6.30	0.98	7.30	1.12	7.80	1.20	8.30	1.28	9.30	1.44	10.40	1.61	
23	5.30	0.85	6.30	0.99	7.30	1.14	7.80	1.22	8.30	1.30	9.30	1.47	10.40	1.64	
25	5.30	0.86	6.30	1.00	7.30	1.16	7.80	1.24	8.30	1.34	9.30	1.54	10.40	1.75	
27	5.30	0.88	6.30	1.04	7.30	1.22	7.80	1.32	8.30	1.42	9.30	1.64	10.40	1.87	
29	5.30	0.92	6.30	1.10	7.30	1.30	7.80	1.41	8.30	1.52	9.30	1.74	10.40	1.99	
31	5.30	0.98	6.30	1.17	7.30	1.38	7.80	1.49	8.30	1.61	9.30	1.85	10.30	2.12	
33	5.30	1.03	6.30	1.24	7.30	1.46	7.80	1.58	8.30	1.71	9.30	1.97	10.30	2.26	
35	5.20	1.09	6.20	1.31	7.30	1.54	7.80	1.67	8.30	1.81	9.30	2.09	10.30	2.39	
37	5.10	1.09	6.10	1.31	7.00	1.55	7.50	1.68	8.00	1.82	9.00	2.11	10.00	2.41	
39	5.00	1.09	5.90	1.31	6.90	1.56	7.40	1.69	7.80	1.82	8.80	2.12	9.80	2.43	
42	5.00	1.15	5.90	1.39	6.90	1.65	7.40	1.79	7.80	1.92	8.80	2.24	9.80	2.58	
44	5.00	1.21	5.90	1.46	6.90	1.74	7.40	1.89	7.80	2.02	8.80	2.37	9.80	2.73	
46	5.00	1.27	5.90	1.54	6.90	1.83	7.40	1.99	7.80	2.12	8.80	2.49	9.80	2.88	

NOTE

- Capacity table may be subject to change without prior notice.
- Capacity table comply with EN14511.
- Cooling capacities are based on;
 - Indoor temperature : 27°C DB, 19°C WB
 - Outdoor temperature : 35°C DB, 24°C WB, Equivalent refrigerant piping : 7.5m, Level differences : 0m
- Heating capacities are based on;
 - Indoor temperature : 20°C DB, 15°C WB
 - Outdoor temperature : 7°C DB, 6°C WB, Equivalent refrigerant piping : 7.5m, Level differences : 0m

10. Capacity Table

Heating

TC : Total Capacity, PI : Power Input

Combination, % (Capacity index)	Outdoor temperature (°C)		Indoor temperature (°C, DB)											
			16		18		20		22		24			
	DB	WB	TC kW	PI kW	TC kW	PI kW	TC kW	PI kW	TC kW	PI kW	TC kW	PI kW		
130	15	14	23.30	4.48	23.20	4.58	23.20	4.68	22.60	4.60	21.00	4.22		
	13	12	22.60	4.42	22.60	4.52	22.50	4.62	22.50	4.72	21.00	4.37		
	11	10	21.80	4.36	21.80	4.47	21.80	4.57	21.70	4.68	21.00	4.54		
	9	8	21.20	4.29	21.20	4.40	21.10	4.51	21.10	4.62	21.00	4.72		
	7	6	20.60	4.27	20.50	4.38	20.50	4.50	20.50	4.62	20.40	4.73		
	5	4	19.90	4.25	19.90	4.36	19.90	4.48	19.80	4.61	19.80	4.72		
	3	2	19.30	4.17	19.30	4.29	19.20	4.42	19.20	4.54	19.10	4.66		
	0	-1	18.20	4.04	18.20	4.18	18.20	4.30	18.10	4.43	18.10	4.56		
	-3	-4	17.20	3.89	17.20	4.03	17.20	4.17	17.10	4.31	17.10	4.45		
	-5	-6	16.60	3.98	16.60	4.14	16.50	4.29	16.50	4.43	16.40	4.58		
	-7	-8	15.90	3.86	15.90	4.02	15.90	4.18	15.80	4.33	15.80	4.49		
	-10	-11	14.70	3.77	14.70	3.94	14.60	4.11	14.60	4.30	14.50	4.47		
	-12	-13	14.00	3.60	14.00	3.79	14.00	3.97	13.90	4.15	13.90	4.34		
	-15	-16	13.40	3.42	13.30	3.61	13.30	3.82	13.20	4.01	13.20	4.20		
	-17	-18	12.70	3.14	12.70	3.33	12.60	3.53	12.60	3.73	12.50	3.93		
	-20	-21	11.60	2.80	11.60	3.02	11.50	3.24	11.50	3.45	11.40	3.67		
	120	15	14	23.20	4.61	23.20	4.71	23.20	4.82	20.80	4.17	19.40	3.84	
13		12	22.60	4.56	22.50	4.65	22.30	4.69	20.80	4.32	19.40	3.97		
11		10	21.80	4.50	21.80	4.60	21.70	4.70	20.80	4.49	19.40	4.12		
9		8	21.20	4.44	21.10	4.54	21.10	4.64	20.80	4.66	19.40	4.28		
7		6	20.50	4.43	20.50	4.53	20.40	4.63	20.40	4.75	19.40	4.49		
5		4	19.90	4.41	19.90	4.51	19.80	4.62	19.80	4.74	19.40	4.72		
3		2	19.30	4.33	19.20	4.45	19.20	4.56	19.10	4.67	19.10	4.78		
0		-1	18.20	4.22	18.20	4.33	18.10	4.46	18.10	4.58	18.00	4.70		
-3		-4	17.20	4.08	17.10	4.21	17.10	4.33	17.10	4.47	17.00	4.59		
-5		-6	16.60	4.19	16.50	4.33	16.50	4.46	16.40	4.60	16.40	4.74		
-7		-8	15.90	4.07	15.80	4.22	15.80	4.36	15.80	4.50	15.70	4.65		
-10		-11	14.60	4.00	14.60	4.16	14.60	4.33	14.50	4.49	14.50	4.65		
-12		-13	14.00	3.85	13.90	4.02	13.90	4.19	13.90	4.37	13.80	4.53		
-15		-16	13.30	3.68	13.30	3.87	13.20	4.04	13.20	4.22	13.20	4.41		
-17		-18	12.60	3.40	12.60	3.59	12.60	3.77	12.50	3.96	12.50	4.15		
-20		-21	11.50	3.10	11.50	3.29	11.50	3.49	11.40	3.70	11.40	3.90		
110		15	14	23.00	4.72	21.70	4.39	20.40	4.07	19.10	3.77	17.80	3.47	
	13	12	22.50	4.70	21.70	4.55	20.40	4.22	19.10	3.90	17.80	3.59		
	11	10	21.70	4.64	21.70	4.72	20.40	4.38	19.10	4.05	17.80	3.72		
	9	8	21.10	4.59	21.10	4.69	20.40	4.54	19.10	4.19	17.80	3.85		
	7	6	20.50	4.58	20.40	4.68	20.40	4.77	19.10	4.40	17.80	4.04		
	5	4	19.80	4.57	19.80	4.66	19.80	4.77	19.10	4.62	17.80	4.25		
	3	2	19.20	4.50	19.20	4.61	19.10	4.71	19.10	4.81	17.80	4.43		
	0	-1	18.10	4.39	18.10	4.50	18.10	4.62	18.00	4.72	17.80	4.73		
	-3	-4	17.10	4.27	17.10	4.38	17.10	4.50	17.00	4.62	17.00	4.73		
	-5	-6	16.50	4.38	16.50	4.51	16.40	4.64	16.40	4.77	16.40	4.90		
	-7	-8	15.80	4.29	15.80	4.41	15.80	4.55	15.70	4.68	15.70	4.82		
	-10	-11	14.60	4.23	14.60	4.39	14.50	4.54	14.50	4.68	14.50	4.84		
	-12	-13	13.90	4.10	13.90	4.26	13.90	4.42	13.80	4.57	13.80	4.72		
	-15	-16	13.30	3.95	13.20	4.11	13.20	4.28	13.20	4.44	13.10	4.61		
	-17	-18	12.60	3.67	12.60	3.84	12.50	4.01	12.50	4.19	12.50	4.36		
	-20	-21	11.50	3.38	11.50	3.57	11.40	3.76	11.40	3.94	11.30	4.13		
	100	15	14	20.90	4.20	19.80	3.92	18.20	3.64	17.30	3.38	16.20	3.12	
13		12	20.90	4.35	19.80	4.06	18.20	3.77	17.30	3.49	16.20	3.22		
11		10	20.90	4.51	19.80	4.21	18.20	3.91	17.30	3.61	16.20	3.34		
9		8	20.90	4.69	19.80	4.37	18.20	4.06	17.30	3.75	16.20	3.45		
7		6	20.40	4.74	19.80	4.59	18.00	4.39	17.30	3.93	16.20	3.61		
5		4	19.80	4.73	19.70	4.82	18.00	4.47	17.30	4.13	16.20	3.80		
3		2	19.10	4.66	19.10	4.77	18.00	4.66	17.30	4.30	16.20	3.95		
0		-1	18.10	4.57	18.00	4.66	17.50	4.77	17.30	4.59	16.20	4.21		
-3		-4	17.10	4.46	17.00	4.56	16.50	4.66	17.00	4.77	16.20	4.53		
-5		-6	16.40	4.59	16.40	4.71	15.90	4.83	16.30	4.93	16.20	4.99		
-7		-8	15.80	4.49	15.70	4.62	15.20	4.74	15.70	4.86	15.60	4.97		
-10		-11	14.50	4.48	14.50	4.61	14.20	4.74	14.40	4.89	14.40	5.02		
-12		-13	13.90	4.35	13.80	4.49	13.50	4.63	13.80	4.78	13.70	4.92		
-15		-16	13.20	4.21	13.20	4.36	12.80	4.51	13.10	4.66	13.10	4.81		
-17		-18	12.50	3.95	12.50	4.10	12.20	4.26	12.40	4.41	12.40	4.56		
-20		-21	11.40	3.68	11.40	3.85	11.40	4.02	11.30	4.19	11.30	4.36		
90		15	14	18.90	3.71	17.70	3.47	16.70	3.23	15.70	3.00	14.50	2.77	
	13	12	18.90	3.83	17.70	3.59	16.70	3.34	15.70	3.10	14.50	2.86		
	11	10	18.90	3.98	17.70	3.72	16.70	3.46	15.70	3.21	14.50	2.96		
	9	8	18.90	4.13	17.70	3.85	16.70	3.59	15.70	3.32	14.50	3.06		
	7	6	18.90	4.34	17.70	4.04	16.70	3.75	15.70	3.48	14.50	3.21		
	5	4	18.90	4.55	17.70	4.24	16.70	3.94	15.70	3.65	14.50	3.36		
	3	2	18.90	4.75	17.70	4.42	16.70	4.10	15.70	3.80	14.50	3.50		
	0	-1	18.00	4.74	17.70	4.72	16.70	4.38	15.70	4.04	14.50	3.73		
	-3	-4	17.00	4.63	17.00	4.74	16.70	4.71	15.70	4.34	14.50	3.99		
	-5	-6	16.40	4.80	16.40	4.90	16.30	5.00	15.70	4.79	14.50	4.39		
	-7	-8	15.70	4.71	15.70	4.82	15.70	4.92	15.60	5.03	14.50	4.63		
	-10	-11	14.50	4.71	14.50	4.84	14.40	4.96	14.40	5.08	14.40	5.20		
	-12	-13	13.80	4.60	13.80	4.72	13.80	4.86	13.70	4.99	13.70	5.11		
	-15	-16	13.10	4.48	13.10	4.61	13.10	4.74	13.10	4.88	13.00	5.01		
	-17	-18	12.50	4.22	12.50	4.36	12.40	4.50	12.40	4.63	12.40	4.77		
	-20	-21	11.40	3.98	11.30	4.13	11.30	4.29	11.30	4.44	11.30	4.58		
	80	15	14	16.80	3.24	15.80	3.04	14.80	2.83	13.90	2.64	12.90	2.45	
13		12	16.80	3.35	15.80	3.14	14.80	2.93	13.90	2.72	12.90	2.52		
11		10	16.80	3.47	15.80	3.25	14.80	3.03	13.90	2.82	12.90	2.61		
9		8	16.80	3.60	15.80	3.37	14.80	3.14	13.90	2.91	12.90	2.70		
7		6	16.80	3.77	15.80	3.52	14.80	3.28	13.90	3.05	12.90	2.82		
5		4	16.80	3.96	15.80	3.70	14.80	3.45	13.90	3.19	12.90	2.95		
3		2	16.80	4.12	15.80	3.85	14.80	3.58	13.90	3.31	12.90	3.06		
0		-1	16.80	4.40	15.80	4.10	14.80	3.81	13.90	3.53	12.90	3.26		
-3		-4	16.80	4.73	15.80	4.40	14.80	4.09	13.90	3.78	12.90	3.48		
-5		-6	16.30	4.99	15.80	4.85	14.80	4.50	13.90	4.16	12.90	3.82		

10. Capacity Table

Heating

TC : Total Capacity, PI : Power Input

Combination, % (Capacity Index)	Outdoor temperature (°C)		Indoor temperature (°C, DB)									
			16		18		20		22		24	
	DB	WB	TC kW	PI kW	TC kW	PI kW	TC kW	PI kW	TC kW	PI kW	TC kW	PI kW
80	-7	-8	15.70	4.91	15.60	5.01	14.80	4.74	13.90	4.37	12.90	4.03
	-10	-11	14.40	4.95	14.40	5.06	14.40	5.17	13.90	5.00	12.90	4.59
	-12	-13	13.80	4.85	13.70	4.97	13.70	5.08	13.70	5.19	12.90	4.87
	-15	-16	13.10	4.73	13.10	4.86	13.00	4.98	13.00	5.10	12.90	5.19
	-17	-18	12.40	4.49	12.40	4.60	12.40	4.73	12.30	4.85	12.30	4.98
	-20	-21	11.30	4.28	11.30	4.41	11.30	4.54	11.20	4.68	11.20	4.81
	-15	-14	14.60	2.80	13.80	2.62	13.00	2.46	12.20	2.29	11.30	2.13
70	13	12	14.60	2.89	13.80	2.71	13.00	2.53	12.20	2.36	11.30	2.19
	11	10	14.60	2.99	13.80	2.80	13.00	2.61	12.20	2.44	11.30	2.27
	9	8	14.60	3.09	13.80	2.90	13.00	2.71	12.20	2.52	11.30	2.34
	7	6	14.60	3.23	13.80	3.03	13.00	2.83	12.20	2.63	11.30	2.45
	5	4	14.60	3.39	13.80	3.17	13.00	2.97	12.20	2.75	11.30	2.56
	3	2	14.60	3.53	13.80	3.30	13.00	3.08	12.20	2.86	11.30	2.65
	0	-1	14.60	3.75	13.80	3.51	13.00	3.27	12.20	3.03	11.30	2.81
	-3	-4	14.60	4.03	13.80	3.76	13.00	3.50	12.20	3.25	11.30	3.00
	-5	-6	14.60	4.43	13.80	4.14	13.00	3.84	12.20	3.56	11.30	3.29
	-7	-8	14.60	4.67	13.80	4.35	13.00	4.05	12.20	3.75	11.30	3.45
	-10	-11	14.40	5.19	13.80	4.97	13.00	4.61	12.20	4.27	11.30	3.93
	-12	-13	13.70	5.10	13.70	5.20	13.00	4.90	12.20	4.52	11.30	4.15
	-15	-16	13.00	5.00	13.00	5.10	13.00	5.21	12.20	4.82	11.30	4.42
	-17	-18	12.40	4.75	12.30	4.86	12.30	4.97	12.20	5.00	11.30	4.59
-20	-21	11.30	4.57	11.20	4.69	11.20	4.80	11.20	4.92	11.20	5.04	
60	15	14	12.60	2.38	11.90	2.23	11.10	2.09	10.40	1.96	9.70	1.83
	13	12	12.60	2.45	11.90	2.30	11.10	2.16	10.40	2.02	9.70	1.88
	11	10	12.60	2.52	11.90	2.38	11.10	2.23	10.40	2.08	9.70	1.94
	9	8	12.60	2.61	11.90	2.45	11.10	2.30	10.40	2.15	9.70	2.00
	7	6	12.60	2.73	11.90	2.57	11.10	2.40	10.40	2.24	9.70	2.09
	5	4	12.60	2.86	11.90	2.68	11.10	2.51	10.40	2.34	9.70	2.17
	3	2	12.60	2.97	11.90	2.78	11.10	2.60	10.40	2.42	9.70	2.26
	0	-1	12.60	3.15	11.90	2.95	11.10	2.76	10.40	2.57	9.70	2.39
	-3	-4	12.60	3.37	11.90	3.15	11.10	2.94	10.40	2.73	9.70	2.54
	-5	-6	12.60	3.70	11.90	3.46	11.10	3.22	10.40	3.00	9.70	2.78
	-7	-8	12.60	3.89	11.90	3.64	11.10	3.39	10.40	3.15	9.70	2.91
	-10	-11	12.60	4.43	11.90	4.13	11.10	3.85	10.40	3.57	9.70	3.30
	-12	-13	12.60	4.70	11.90	4.39	11.10	4.08	10.40	3.78	9.70	3.49
	-15	-16	12.60	5.01	11.90	4.66	11.10	4.34	10.40	4.01	9.70	3.69
-17	-18	12.30	5.03	11.90	4.85	11.10	4.51	10.40	4.16	9.70	3.83	
-20	-21	11.20	4.87	11.20	4.97	11.10	5.02	10.40	4.62	9.70	4.26	
50	15	14	10.50	1.97	9.90	1.86	9.30	1.75	8.70	1.64	8.10	1.54
	13	12	10.50	2.03	9.90	1.92	9.30	1.80	8.70	1.69	8.10	1.58
	11	10	10.50	2.09	9.90	1.97	9.30	1.85	8.70	1.74	8.10	1.62
	9	8	10.50	2.16	9.90	2.04	9.30	1.91	8.70	1.79	8.10	1.68
	7	6	10.50	2.25	9.90	2.12	9.30	1.99	8.70	1.86	8.10	1.74
	5	4	10.50	2.35	9.90	2.22	9.30	2.08	8.70	1.95	8.10	1.82
	3	2	10.50	2.43	9.90	2.29	9.30	2.15	8.70	2.01	8.10	1.88
	0	-1	10.50	2.58	9.90	2.42	9.30	2.27	8.70	2.13	8.10	1.98
	-3	-4	10.50	2.75	9.90	2.58	9.30	2.42	8.70	2.26	8.10	2.10
	-5	-6	10.50	3.02	9.90	2.83	9.30	2.65	8.70	2.47	8.10	2.30
	-7	-8	10.50	3.17	9.90	2.97	9.30	2.77	8.70	2.59	8.10	2.40
	-10	-11	10.50	3.59	9.90	3.36	9.30	3.14	8.70	2.92	8.10	2.70
	-12	-13	10.50	3.80	9.90	3.55	9.30	3.32	8.70	3.08	8.10	2.86
	-15	-16	10.50	4.03	9.90	3.78	9.30	3.51	8.70	3.27	8.10	3.02
-17	-18	10.50	4.19	9.90	3.91	9.30	3.64	8.70	3.37	8.10	3.12	
-20	-21	10.50	4.65	9.90	4.35	9.30	4.04	8.70	3.74	8.10	3.44	

NOTE

- Capacity table may be subject to change without prior notice.
- Capacity table comply with EN14511.
- Cooling capacities are based on;
 - Indoor temperature : 27°C DB, 19°C WB
 - Outdoor temperature : 35°C DB, 24°C WB, Equivalent refrigerant piping : 7.5m, Level differences : 0m
- Heating capacities are based on;
 - Indoor temperature : 20°C DB, 15°C WB
 - Outdoor temperature : 7°C DB, 6°C WB, Equivalent refrigerant piping : 7.5m, Level differences : 0m

10. Capacity Table

AM060FXMDGH/EU

Cooling

TC : Total Capacity, PI : Power Input

Combination, % (Capacity Index)	Outdoor temperature (°C, DB)	Indoor temperature (°C, WB)													
		14		16		18		19		20		22		24	
		TC kW	PI kW	TC kW	PI kW	TC kW	PI kW	TC kW	PI kW	TC kW	PI kW	TC kW	PI kW	TC kW	PI kW
130	10	13.80	1.98	16.40	2.43	19.10	2.89	20.50	3.12	20.70	3.06	21.20	2.93	21.70	2.79
	12	13.80	2.02	16.40	2.47	19.10	2.94	20.20	3.10	20.40	3.04	20.90	2.91	21.40	2.86
	14	13.80	2.06	16.40	2.52	19.00	3.00	19.90	3.09	20.20	3.02	20.70	3.00	21.20	3.02
	16	13.80	2.10	16.40	2.58	19.00	3.06	19.60	3.11	19.80	3.13	20.30	3.16	20.90	3.19
	18	13.80	2.14	16.40	2.62	19.00	3.26	19.30	3.28	19.50	3.29	20.00	3.32	20.50	3.35
	20	13.70	2.18	16.40	2.79	18.80	3.42	19.00	3.43	19.30	3.45	19.80	3.49	20.30	3.52
	21	13.70	2.25	16.40	2.89	18.70	3.50	18.90	3.52	19.20	3.53	19.60	3.56	20.10	3.60
	23	13.70	2.40	16.30	3.10	18.40	3.66	18.60	3.68	18.90	3.70	19.40	3.73	19.90	3.76
	25	13.70	2.57	16.30	3.32	18.00	3.82	18.30	3.84	18.50	3.85	19.00	3.89	19.50	3.93
	27	13.70	2.75	16.30	3.55	17.80	3.98	18.00	4.00	18.30	4.02	18.80	4.05	19.20	4.10
	29	13.70	2.93	16.30	3.80	17.50	4.14	17.80	4.16	18.00	4.18	18.50	4.23	19.00	4.26
	31	13.70	3.12	16.30	4.05	17.30	4.30	17.50	4.32	17.70	4.35	18.20	4.39	18.70	4.44
	33	13.60	3.33	16.30	4.33	17.00	4.47	17.20	4.48	17.50	4.51	18.00	4.56	18.50	4.60
	35	13.60	3.54	16.10	4.57	16.60	4.63	16.90	4.65	17.10	4.68	17.60	4.73	18.10	4.78
	37	13.20	3.59	15.40	4.50	15.90	4.55	16.10	4.57	16.40	4.60	16.80	4.65	17.30	4.70
	39	12.90	3.62	14.80	4.41	15.30	4.46	15.50	4.49	15.80	4.51	16.30	4.56	16.70	4.61
42	12.90	3.83	14.50	4.56	15.00	4.61	15.20	4.64	15.50	4.67	16.10	4.72	16.50	4.77	
44	12.90	4.04	14.30	4.71	14.70	4.76	14.90	4.80	15.20	4.82	15.90	4.87	16.30	4.92	
46	12.90	4.26	14.00	4.86	14.40	4.91	14.60	4.96	14.90	4.98	15.70	5.03	16.20	5.08	
120	10	12.80	1.82	15.20	2.22	17.70	2.63	18.90	2.85	20.10	3.06	20.80	3.02	21.30	2.90
	12	12.80	1.84	15.20	2.26	17.60	2.68	18.90	2.90	20.10	3.12	20.60	3.00	21.00	2.88
	14	12.80	1.88	15.20	2.30	17.60	2.74	18.80	2.96	19.90	3.10	20.30	2.99	20.80	3.00
	16	12.80	1.92	15.20	2.35	17.60	2.79	18.80	3.01	19.50	3.11	20.00	3.14	20.40	3.17
	18	12.70	1.95	15.20	2.39	17.60	2.89	18.80	3.20	19.20	3.27	19.70	3.30	20.10	3.32
	20	12.70	1.99	15.20	2.48	17.60	3.10	18.80	3.42	19.00	3.43	19.40	3.46	19.90	3.49
	21	12.70	2.01	15.10	2.58	17.60	3.21	18.60	3.50	18.80	3.52	19.30	3.54	19.80	3.57
	23	12.70	2.15	15.10	2.76	17.50	3.44	18.40	3.65	18.60	3.67	19.00	3.71	19.50	3.73
	25	12.70	2.29	15.10	2.95	17.50	3.69	18.00	3.82	18.20	3.84	18.70	3.86	19.10	3.90
	27	12.70	2.45	15.10	3.16	17.50	3.95	17.70	3.97	18.00	3.99	18.40	4.03	18.90	4.06
	29	12.70	2.61	15.10	3.37	17.20	4.12	17.50	4.14	17.70	4.15	18.10	4.19	18.60	4.24
	31	12.70	2.79	15.10	3.60	17.00	4.27	17.20	4.30	17.40	4.32	17.90	4.36	18.30	4.40
	33	12.60	2.97	15.10	3.84	16.70	4.44	16.90	4.46	17.20	4.48	17.60	4.52	18.10	4.57
	35	12.60	3.16	15.00	4.09	16.40	4.60	16.60	4.62	16.80	4.65	17.30	4.69	17.70	4.74
	37	12.20	3.19	14.60	4.14	15.60	4.52	15.80	4.55	16.00	4.57	16.50	4.61	17.00	4.66
	39	12.00	3.22	14.30	4.18	15.00	4.43	15.30	4.45	15.50	4.48	15.90	4.52	16.30	4.57
42	12.00	3.42	14.30	4.45	14.70	4.58	15.10	4.60	15.30	4.63	15.60	4.67	16.10	4.73	
44	12.00	3.62	14.30	4.71	14.40	4.73	14.90	4.75	15.10	4.77	15.30	4.82	15.80	4.88	
46	12.00	3.81	14.30	4.97	14.20	4.87	14.70	4.90	14.90	4.92	15.00	4.96	15.50	5.04	
110	10	11.70	1.64	13.90	2.01	16.10	2.38	17.40	2.58	18.50	2.77	20.50	3.11	20.90	3.00
	12	11.70	1.68	13.90	2.05	16.10	2.43	17.30	2.62	18.50	2.82	20.20	3.10	20.60	2.99
	14	11.70	1.71	13.90	2.08	16.10	2.47	17.30	2.68	18.40	2.88	20.00	3.08	20.40	2.99
	16	11.60	1.73	13.90	2.12	16.10	2.52	17.30	2.72	18.40	2.93	19.60	3.12	20.00	3.14
	18	11.60	1.77	13.90	2.16	16.10	2.58	17.30	2.80	18.40	3.08	19.30	3.28	19.80	3.31
	20	11.60	1.81	13.80	2.21	16.10	2.72	17.30	3.01	18.40	3.31	19.10	3.44	19.50	3.47
	21	11.60	1.83	13.80	2.27	16.00	2.82	17.30	3.11	18.40	3.43	19.00	3.52	19.40	3.54
	23	11.60	1.91	13.80	2.44	16.00	3.02	17.20	3.34	18.20	3.65	18.70	3.68	19.10	3.71
	25	11.60	2.04	13.80	2.60	16.00	3.24	17.20	3.58	17.90	3.81	18.30	3.84	18.70	3.87
	27	11.60	2.17	13.80	2.79	16.00	3.46	17.20	3.84	17.70	3.97	18.10	4.00	18.50	4.04
	29	11.60	2.32	13.80	2.97	16.00	3.70	17.20	4.10	17.40	4.13	17.80	4.16	18.20	4.20
	31	11.60	2.47	13.80	3.17	16.00	3.95	16.90	4.27	17.10	4.29	17.50	4.33	18.00	4.36
	33	11.50	2.63	13.70	3.38	16.00	4.22	16.70	4.43	16.90	4.45	17.30	4.49	17.70	4.53
	35	11.50	2.79	13.70	3.60	15.90	4.50	16.30	4.59	16.50	4.61	16.90	4.66	17.30	4.69
	37	11.20	2.82	13.30	3.63	15.30	4.49	15.50	4.52	15.70	4.54	16.20	4.58	16.60	4.62
	39	10.90	2.84	13.00	3.67	14.80	4.40	15.00	4.43	15.20	4.45	15.60	4.49	16.00	4.53
42	10.90	3.02	13.00	3.89	14.60	4.55	14.80	4.58	15.00	4.59	15.30	4.64	15.70	4.68	
44	10.90	3.19	13.00	4.11	14.40	4.70	14.60	4.73	14.80	4.74	15.00	4.78	15.40	4.82	
46	10.90	3.36	13.00	4.33	14.30	4.85	14.40	4.87	14.60	4.89	14.70	4.93	15.10	4.97	
100	10	10.70	1.49	12.70	1.80	14.70	2.14	15.70	2.30	16.80	2.48	18.80	2.83	20.50	3.10
	12	10.70	1.51	12.70	1.84	14.70	2.17	15.70	2.35	16.70	2.53	18.80	2.89	20.30	3.09
	14	10.60	1.53	12.70	1.87	14.70	2.22	15.70	2.39	16.70	2.58	18.70	2.94	20.00	3.07
	16	10.60	1.56	12.70	1.90	14.70	2.26	15.70	2.44	16.70	2.62	18.70	3.00	19.60	3.12
	18	10.60	1.60	12.60	1.94	14.70	2.30	15.70	2.49	16.70	2.68	18.70	3.17	19.40	3.28
	20	10.60	1.63	12.60	1.98	14.70	2.37	15.70	2.61	16.70	2.87	18.70	3.42	19.10	3.44
	21	10.60	1.64	12.60	2.00	14.60	2.46	15.60	2.70	16.70	2.97	18.60	3.50	19.00	3.52
	23	10.60	1.68	12.60	2.13	14.60	2.63	15.60	2.90	16.60	3.19	18.20	3.65	18.70	3.68
	25	10.60	1.80	12.60	2.27	14.60	2.81	15.60	3.10	16.60	3.42	18.00	3.82	18.40	3.84
	27	10.60	1.92	12.60	2.43	14.60	3.00	15.60	3.32	16.60	3.65	17.70	3.97	18.10	4.01
	29	10.60	2.04	12.60	2.59	14.60	3.21	15.60	3.55	16.60	3.90	17.50	4.14	17.80	4.16
	31	10.50	2.17	12.60	2.77	14.60	3.42	15.60	3.79	16.60	4.16	17.20	4.29	17.60	4.33
	33	10.50	2.31	12.50	2.94	14.50	3.65	15.60	4.05	16.60	4.42	16.90	4.46	17.30	4.49
	35	10.50	2.46	12.50	3.13	14.50	3.90	15.50	4.31	16.20	4.58	16.60	4.62	16.90	4.66
	37	10.20	2.47	12.10	3.17	14.10	3.95	15.00	4.36	15.40	4.51	15.80	4.55	16.20	4.58
	39	10.00	2.49	11.90	3.19	13.80	3.98	14.70	4.40	14.90	4.41	15.20	4.45	15.60	4.50
42	10.00	2.64	11.90	3.38	13.80	4.22	14.70	4.66	14.70	4.55	14.90	4.60	15.30	4.65	
44	10.00	2.79	11.90	3.57	13.80	4.45	14.70	4.92	14.50	4.69	14.60	4.75	15.00	4.81	
46	10.00	2.93	11.90	3.76	13.80	4.69	14.70	5.19	14.40	4.83	14.40	4.90	14.70	4.96	
90	10	9.60	1.33	11.40	1.61	13.20	1.89	14.20	2.05	15.10	2.19	17.00	2.51	18.80	2.83
	12	9.50	1.35	11.40	1.63	13.20	1.93	14.20	2.08	15.10	2.24	16.90	2.56	18.80	2.88
	14	9.50	1.38	11.40	1.66	13.20	1.96	14.20	2.12	15.10	2.28	16.90	2.60	18.70	2.93
	16	9.50	1.40	11.30	1.69	13.20	2.00	14.20	2.16	15.10	2.32	16.90	2.66	18.70	3.00
	18	9.50	1.42	11.30	1.73	13.10	2.04	14.20	2.20	15.10	2.37	16.90	2.71	18.70	3.16
	20	9.50	1.45	11.30	1.75	13.10	2.08								

10. Capacity Table

Cooling

TC : Total Capacity, PI : Power Input

Combination, % (Capacity index)	Outdoor temperature (°C, DB)	Indoor temperature (°C, WB)															
		14		16		18		19		20		22		24			
		TC kW	PI kW	TC kW	PI kW	TC kW	PI kW	TC kW	PI kW	TC kW	PI kW	TC kW	PI kW	TC kW	PI kW		
90	37	9.10	2.15	10.90	2.73	12.60	3.37	13.60	3.72	14.50	4.09	15.50	4.51	15.80	4.55		
	39	8.90	2.16	10.60	2.74	12.40	3.40	13.30	3.76	14.20	4.13	14.90	4.42	15.20	4.45		
	42	8.90	2.28	10.60	2.90	12.40	3.61	13.30	3.99	14.20	4.39	14.60	4.57	14.90	4.60		
	44	8.90	2.41	10.60	3.06	12.40	3.81	13.30	4.22	14.20	4.64	14.40	4.72	14.60	4.75		
	46	8.90	2.53	10.60	3.21	12.40	4.02	13.30	4.45	14.20	4.90	14.10	4.87	14.40	4.90		
	10	8.50	1.18	10.20	1.42	11.80	1.66	12.60	1.79	13.40	1.92	15.00	2.19	16.70	2.47		
	12	8.50	1.20	10.10	1.43	11.80	1.69	12.60	1.82	13.40	1.95	15.00	2.23	16.60	2.51		
14	8.50	1.21	10.10	1.46	11.80	1.72	12.60	1.85	13.40	1.99	15.00	2.27	16.60	2.56			
16	8.50	1.24	10.10	1.49	11.70	1.75	12.60	1.89	13.40	2.03	15.00	2.32	16.60	2.61			
18	8.50	1.26	10.10	1.52	11.70	1.79	12.50	1.93	13.40	2.07	15.00	2.37	16.60	2.67			
20	8.50	1.29	10.10	1.54	11.70	1.82	12.50	1.96	13.30	2.11	15.00	2.45	16.60	2.85			
21	8.50	1.30	10.10	1.56	11.70	1.84	12.50	1.98	13.30	2.16	14.90	2.54	16.60	2.95			
23	8.40	1.31	10.10	1.59	11.70	1.93	12.50	2.11	13.30	2.30	14.90	2.72	16.50	3.16			
25	8.40	1.36	10.10	1.69	11.70	2.06	12.50	2.26	13.30	2.47	14.90	2.90	16.50	3.39			
27	8.40	1.45	10.10	1.80	11.70	2.20	12.50	2.41	13.30	2.63	14.90	3.10	16.50	3.63			
29	8.40	1.54	10.10	1.92	11.70	2.34	12.50	2.57	13.30	2.81	14.90	3.32	16.50	3.87			
31	8.40	1.63	10.00	2.04	11.70	2.49	12.50	2.74	13.30	3.00	14.90	3.54	16.50	4.14			
33	8.40	1.73	10.00	2.17	11.60	2.66	12.40	2.91	13.20	3.19	14.80	3.78	16.50	4.42			
35	8.40	1.84	10.00	2.30	11.60	2.82	12.40	3.10	13.20	3.40	14.80	4.03	16.20	4.58			
37	8.10	1.85	9.70	2.32	11.30	2.85	12.00	3.14	12.80	3.44	14.40	4.08	15.40	4.50			
39	8.00	1.86	9.50	2.33	11.00	2.88	11.80	3.16	12.50	3.47	14.10	4.12	14.90	4.41			
42	8.00	1.96	9.50	2.47	11.00	3.05	11.80	3.35	12.50	3.68	14.10	4.37	14.70	4.56			
44	8.00	2.07	9.50	2.60	11.00	3.22	11.80	3.54	12.50	3.90	14.10	4.63	14.50	4.71			
46	8.00	2.18	9.50	2.73	11.00	3.39	11.80	3.73	12.50	4.11	14.10	4.88	14.40	4.86			
10	7.40	1.04	8.90	1.23	10.30	1.43	11.10	1.54	11.80	1.65	13.20	1.88	14.60	2.12			
12	7.40	1.05	8.90	1.25	10.20	1.46	11.10	1.57	11.80	1.68	13.20	1.92	14.60	2.16			
14	7.40	1.07	8.80	1.27	10.20	1.49	11.00	1.60	11.80	1.72	13.20	1.95	14.60	2.19			
16	7.40	1.09	8.80	1.30	10.20	1.52	11.00	1.63	11.70	1.74	13.20	1.99	14.60	2.24			
18	7.40	1.10	8.80	1.31	10.20	1.54	11.00	1.66	11.70	1.78	13.10	2.03	14.60	2.28			
20	7.40	1.12	8.80	1.34	10.20	1.57	11.00	1.69	11.70	1.82	13.10	2.06	14.50	2.35			
21	7.40	1.13	8.80	1.35	10.20	1.59	11.00	1.71	11.70	1.84	13.10	2.10	14.50	2.43			
23	7.40	1.15	8.80	1.38	10.20	1.62	11.00	1.76	11.70	1.92	13.10	2.25	14.50	2.60			
25	7.40	1.18	8.80	1.43	10.20	1.73	11.00	1.88	11.70	2.05	13.10	2.40	14.50	2.79			
27	7.40	1.24	8.80	1.52	10.20	1.84	11.00	2.01	11.70	2.19	13.10	2.57	14.50	2.98			
29	7.40	1.31	8.80	1.63	10.20	1.96	11.00	2.14	11.70	2.33	13.10	2.74	14.50	3.18			
31	7.40	1.40	8.80	1.73	10.10	2.08	10.90	2.28	11.70	2.48	13.10	2.91	14.50	3.39			
33	7.30	1.48	8.80	1.83	10.10	2.22	10.90	2.43	11.60	2.64	13.00	3.10	14.40	3.62			
35	7.30	1.57	8.70	1.94	10.10	2.36	10.90	2.58	11.60	2.81	13.00	3.31	14.40	3.85			
37	7.10	1.58	8.50	1.95	9.80	2.38	10.60	2.60	11.30	2.84	12.60	3.35	14.00	3.89			
39	7.00	1.58	8.30	1.96	9.60	2.39	10.40	2.62	11.00	2.86	12.40	3.38	13.70	3.93			
42	7.00	1.66	8.30	2.08	9.60	2.53	10.40	2.78	11.00	3.03	12.40	3.58	13.70	4.17			
44	7.00	1.74	8.30	2.19	9.60	2.67	10.40	2.93	11.00	3.21	12.40	3.79	13.70	4.40			
46	7.00	1.82	8.30	2.31	9.60	2.81	10.40	3.09	11.00	3.38	12.40	3.99	13.70	4.64			
10	6.40	0.90	7.60	1.06	8.80	1.22	9.40	1.31	10.10	1.41	11.30	1.59	12.50	1.78			
12	6.40	0.91	7.60	1.08	8.80	1.24	9.40	1.33	10.00	1.42	11.30	1.62	12.50	1.81			
14	6.40	0.93	7.60	1.10	8.80	1.27	9.40	1.36	10.00	1.45	11.20	1.64	12.50	1.84			
16	6.40	0.94	7.60	1.11	8.80	1.29	9.40	1.38	10.00	1.48	11.20	1.67	12.50	1.88			
18	6.40	0.96	7.60	1.13	8.80	1.31	9.40	1.41	10.00	1.51	11.20	1.71	12.40	1.92			
20	6.30	0.97	7.60	1.15	8.80	1.33	9.40	1.43	10.00	1.53	11.20	1.73	12.40	1.95			
21	6.30	0.98	7.60	1.16	8.80	1.35	9.40	1.44	10.00	1.54	11.20	1.75	12.40	1.97			
23	6.30	1.00	7.60	1.18	8.80	1.37	9.40	1.47	10.00	1.58	11.20	1.83	12.40	2.09			
25	6.30	1.01	7.50	1.20	8.80	1.42	9.40	1.55	10.00	1.67	11.20	1.94	12.40	2.24			
27	6.30	1.05	7.50	1.27	8.80	1.52	9.40	1.64	10.00	1.78	11.20	2.07	12.40	2.39			
29	6.30	1.11	7.50	1.35	8.70	1.62	9.40	1.75	10.00	1.90	11.20	2.21	12.40	2.55			
31	6.30	1.18	7.50	1.43	8.70	1.72	9.30	1.86	9.90	2.02	11.10	2.36	12.40	2.71			
33	6.30	1.24	7.50	1.52	8.70	1.82	9.30	1.98	9.90	2.15	11.10	2.50	12.30	2.89			
35	6.30	1.31	7.50	1.61	8.70	1.93	9.30	2.10	9.90	2.28	11.10	2.67	12.30	3.08			
37	6.10	1.32	7.30	1.61	8.40	1.94	9.00	2.12	9.60	2.30	10.80	2.69	11.90	3.11			
39	6.00	1.32	7.10	1.62	8.30	1.95	8.80	2.13	9.40	2.32	10.60	2.71	11.70	3.13			
42	6.00	1.40	7.10	1.71	8.30	2.05	8.80	2.25	9.40	2.46	10.60	2.88	11.70	3.31			
44	6.00	1.47	7.10	1.80	8.30	2.16	8.80	2.38	9.40	2.60	10.60	3.04	11.70	3.49			
46	6.00	1.55	7.10	1.89	8.30	2.27	8.80	2.50	9.40	2.74	10.60	3.21	11.70	3.67			
10	5.30	0.78	6.30	0.89	7.40	1.03	7.90	1.10	8.40	1.16	9.40	1.31	10.50	1.45			
12	5.30	0.79	6.30	0.91	7.40	1.04	7.90	1.11	8.40	1.19	9.40	1.33	10.40	1.48			
14	5.30	0.79	6.30	0.92	7.30	1.06	7.90	1.13	8.40	1.21	9.40	1.35	10.40	1.51			
16	5.30	0.80	6.30	0.94	7.30	1.08	7.80	1.15	8.40	1.22	9.40	1.38	10.40	1.53			
18	5.30	0.82	6.30	0.95	7.30	1.10	7.80	1.17	8.30	1.24	9.40	1.40	10.40	1.56			
20	5.30	0.83	6.30	0.97	7.30	1.11	7.80	1.19	8.30	1.27	9.40	1.42	10.40	1.59			
21	5.30	0.84	6.30	0.98	7.30	1.12	7.80	1.20	8.30	1.28	9.30	1.44	10.40	1.61			
23	5.30	0.85	6.30	0.99	7.30	1.14	7.80	1.22	8.30	1.30	9.30	1.47	10.40	1.64			
25	5.30	0.86	6.30	1.00	7.30	1.16	7.80	1.24	8.30	1.34	9.30	1.54	10.40	1.75			
27	5.30	0.88	6.30	1.04	7.30	1.22	7.80	1.32	8.30	1.42	9.30	1.64	10.40	1.87			
29	5.30	0.92	6.30	1.10	7.30	1.30	7.80	1.41	8.30	1.52	9.30	1.74	10.40	1.99			
31	5.30	0.98	6.30	1.17	7.30	1.38	7.80	1.49	8.30	1.61	9.30	1.85	10.30	2.12			
33	5.30	1.03	6.30	1.24	7.30	1.46	7.80	1.58	8.30	1.71	9.30	1.97	10.30	2.26			
35	5.20	1.09	6.20	1.31	7.30	1.54	7.80	1.67	8.30	1.81	9.30	2.09	10.30	2.39			
37	5.10	1.09	6.10	1.31	7.00	1.55	7.50	1.68	8.00	1.82	9.00	2.11	10.00	2.41			
39	5.00	1.09	5.90	1.31	6.90	1.56	7.40	1.69	7.80	1.82	8.80	2.12	9.80	2.43			
42	5.00	1.15	5.90	1.39	6.90	1.65	7.40	1.79	7.80	1.92	8.80	2.24	9.80	2.58			
44	5.00	1.21	5.90	1.46	6.90	1.74	7.40	1.89	7.80	2.02	8.80	2.37	9.80	2.73			
46	5.00	1.27	5.90	1.54	6.90	1.83	7.40	1.99	7.80	2.12	8.80	2.49	9.80	2.88			

NOTE

- Capacity table may be subject to change without prior notice.
- Capacity table comply with EN14511.
- Cooling capacities are based on;
 - Indoor temperature : 27°C DB, 19°C WB
 - Outdoor temperature : 35°C DB, 24°C WB, Equivalent refrigerant piping : 7.5m, Level differences : 0m
- Heating capacities are based on;
 - Indoor temperature : 20°C DB, 15°C WB
 - Outdoor temperature : 7°C DB, 6°C WB, Equivalent refrigerant piping : 7.5m, Level differences : 0m

10. Capacity Table

Heating

TC : Total Capacity, PI : Power Input

Combination, % (Capacity index)	Outdoor temperature (°C)		Indoor temperature (°C, DB)									
			16		18		20		22		24	
	DB	WB	TC kW	PI kW	TC kW	PI kW	TC kW	PI kW	TC kW	PI kW	TC kW	PI kW
130	15	14	23.30	4.48	23.20	4.58	23.20	4.68	22.60	4.60	21.00	4.22
	13	12	22.60	4.42	22.60	4.52	22.50	4.62	22.50	4.72	21.00	4.37
	11	10	21.80	4.36	21.80	4.47	21.80	4.57	21.70	4.68	21.00	4.54
	9	8	21.20	4.29	21.20	4.40	21.10	4.51	21.10	4.62	21.00	4.72
	7	6	20.60	4.27	20.50	4.38	20.50	4.50	20.50	4.62	20.40	4.73
	5	4	19.90	4.25	19.90	4.36	19.90	4.48	19.80	4.61	19.80	4.72
	3	2	19.30	4.17	19.30	4.29	19.20	4.42	19.20	4.54	19.10	4.66
	0	-1	18.20	4.04	18.20	4.18	18.20	4.30	18.10	4.43	18.10	4.56
	-3	-4	17.20	3.89	17.20	4.03	17.20	4.17	17.10	4.31	17.10	4.45
	-5	-6	16.60	3.98	16.60	4.14	16.50	4.29	16.50	4.43	16.40	4.58
	-7	-8	15.90	3.86	15.90	4.02	15.90	4.18	15.80	4.33	15.80	4.49
	-10	-11	14.70	3.77	14.70	3.94	14.60	4.11	14.60	4.30	14.50	4.47
	-12	-13	14.00	3.60	14.00	3.79	14.00	3.97	13.90	4.15	13.90	4.34
	-15	-16	13.40	3.42	13.30	3.61	13.30	3.82	13.20	4.01	13.20	4.20
	-17	-18	12.70	3.14	12.70	3.33	12.60	3.53	12.60	3.73	12.50	3.93
	-20	-21	11.60	2.80	11.60	3.02	11.50	3.24	11.50	3.45	11.40	3.67
120	15	14	23.20	4.61	23.20	4.71	22.30	4.52	20.80	4.17	19.40	3.84
	13	12	22.60	4.56	22.50	4.65	22.30	4.69	20.80	4.32	19.40	3.97
	11	10	21.80	4.50	21.80	4.60	21.70	4.70	20.80	4.49	19.40	4.12
	9	8	21.20	4.44	21.10	4.54	21.10	4.64	20.80	4.66	19.40	4.28
	7	6	20.50	4.43	20.50	4.53	20.40	4.63	20.40	4.75	19.40	4.49
	5	4	19.90	4.41	19.90	4.51	19.80	4.62	19.80	4.74	19.40	4.72
	3	2	19.30	4.33	19.20	4.45	19.20	4.56	19.10	4.67	19.10	4.78
	0	-1	18.20	4.22	18.20	4.33	18.10	4.46	18.10	4.58	18.00	4.70
	-3	-4	17.20	4.08	17.10	4.21	17.10	4.33	17.10	4.47	17.00	4.59
	-5	-6	16.60	4.19	16.50	4.33	16.50	4.46	16.40	4.60	16.40	4.74
	-7	-8	15.90	4.07	15.80	4.22	15.80	4.36	15.80	4.50	15.70	4.65
	-10	-11	14.60	4.00	14.60	4.16	14.60	4.33	14.50	4.49	14.50	4.65
	-12	-13	14.00	3.85	13.90	4.02	13.90	4.19	13.90	4.37	13.80	4.53
	-15	-16	13.30	3.68	13.30	3.87	13.20	4.04	13.20	4.22	13.20	4.41
	-17	-18	12.60	3.40	12.60	3.59	12.60	3.77	12.50	3.96	12.50	4.15
	-20	-21	11.50	3.10	11.50	3.29	11.50	3.49	11.40	3.70	11.40	3.90
110	15	14	23.00	4.72	21.70	4.39	20.40	4.07	19.10	3.77	17.80	3.47
	13	12	22.50	4.70	21.70	4.55	20.40	4.22	19.10	3.90	17.80	3.59
	11	10	21.70	4.64	21.70	4.72	20.40	4.38	19.10	4.05	17.80	3.72
	9	8	21.10	4.59	21.10	4.69	20.40	4.54	19.10	4.19	17.80	3.85
	7	6	20.50	4.58	20.40	4.68	20.40	4.77	19.10	4.40	17.80	4.04
	5	4	19.80	4.57	19.80	4.66	19.80	4.77	19.10	4.62	17.80	4.25
	3	2	19.20	4.50	19.20	4.61	19.10	4.71	19.10	4.81	17.80	4.43
	0	-1	18.10	4.39	18.10	4.50	18.10	4.62	18.00	4.72	17.80	4.73
	-3	-4	17.10	4.27	17.10	4.38	17.10	4.50	17.00	4.62	17.00	4.73
	-5	-6	16.50	4.38	16.50	4.51	16.40	4.64	16.40	4.77	16.40	4.90
	-7	-8	15.80	4.29	15.80	4.41	15.80	4.55	15.70	4.68	15.70	4.82
	-10	-11	14.60	4.23	14.60	4.39	14.50	4.54	14.50	4.68	14.50	4.84
	-12	-13	13.90	4.10	13.90	4.26	13.90	4.42	13.80	4.57	13.80	4.72
	-15	-16	13.30	3.95	13.20	4.11	13.20	4.28	13.20	4.44	13.10	4.61
	-17	-18	12.60	3.67	12.60	3.84	12.50	4.01	12.50	4.19	12.50	4.36
	-20	-21	11.50	3.38	11.50	3.57	11.40	3.76	11.40	3.94	11.30	4.13
100	15	14	20.90	4.20	19.80	3.92	18.20	3.64	17.30	3.38	16.20	3.12
	13	12	20.90	4.35	19.80	4.06	18.20	3.77	17.30	3.49	16.20	3.22
	11	10	20.90	4.51	19.80	4.21	18.20	3.91	17.30	3.61	16.20	3.34
	9	8	20.90	4.69	19.80	4.37	18.20	4.06	17.30	3.75	16.20	3.45
	7	6	20.40	4.74	19.80	4.59	18.00	4.39	17.30	3.93	16.20	3.61
	5	4	19.80	4.73	19.70	4.82	18.00	4.47	17.30	4.13	16.20	3.80
	3	2	19.10	4.66	19.10	4.77	18.00	4.66	17.30	4.30	16.20	3.95
	0	-1	18.10	4.57	18.00	4.66	17.50	4.77	17.30	4.59	16.20	4.21
	-3	-4	17.10	4.46	17.00	4.56	16.50	4.66	17.00	4.77	16.20	4.53
	-5	-6	16.40	4.59	16.40	4.71	15.90	4.83	16.30	4.93	16.20	4.99
	-7	-8	15.80	4.49	15.70	4.62	15.20	4.74	15.70	4.86	15.60	4.97
	-10	-11	14.50	4.48	14.50	4.61	14.20	4.74	14.40	4.89	14.40	5.02
	-12	-13	13.90	4.35	13.80	4.49	13.50	4.63	13.80	4.78	13.70	4.92
	-15	-16	13.20	4.21	13.20	4.36	12.80	4.51	13.10	4.66	13.10	4.81
	-17	-18	12.50	3.95	12.50	4.10	12.20	4.26	12.40	4.41	12.40	4.56
	-20	-21	11.40	3.68	11.40	3.85	11.40	4.02	11.30	4.19	11.30	4.36
90	15	14	18.90	3.71	17.70	3.47	16.70	3.23	15.70	3.00	14.50	2.77
	13	12	18.90	3.83	17.70	3.59	16.70	3.34	15.70	3.10	14.50	2.86
	11	10	18.90	3.98	17.70	3.72	16.70	3.46	15.70	3.21	14.50	2.96
	9	8	18.90	4.13	17.70	3.85	16.70	3.59	15.70	3.32	14.50	3.06
	7	6	18.90	4.34	17.70	4.04	16.70	3.75	15.70	3.48	14.50	3.21
	5	4	18.90	4.55	17.70	4.24	16.70	3.94	15.70	3.65	14.50	3.36
	3	2	18.90	4.75	17.70	4.42	16.70	4.10	15.70	3.80	14.50	3.50
	0	-1	18.00	4.74	17.70	4.72	16.70	4.38	15.70	4.04	14.50	3.73
	-3	-4	17.00	4.63	17.00	4.74	16.70	4.71	15.70	4.34	14.50	3.99
	-5	-6	16.40	4.80	16.40	4.90	16.30	5.00	15.70	4.79	14.50	4.39
	-7	-8	15.70	4.71	15.70	4.82	15.70	4.92	15.60	5.03	14.50	4.63
	-10	-11	14.50	4.71	14.50	4.84	14.40	4.96	14.40	5.08	14.40	5.20
	-12	-13	13.80	4.60	13.80	4.72	13.80	4.86	13.70	4.99	13.70	5.11
	-15	-16	13.10	4.48	13.10	4.61	13.10	4.74	13.10	4.88	13.00	5.01
	-17	-18	12.50	4.22	12.50	4.36	12.40	4.50	12.40	4.63	12.40	4.77
	-20	-21	11.40	3.98	11.30	4.13	11.30	4.29	11.30	4.44	11.30	4.58
80	15	14	16.80	3.24	15.80	3.04	14.80	2.83	13.90	2.64	12.90	2.45
	13	12	16.80	3.35	15.80	3.14	14.80	2.93	13.90	2.72	12.90	2.52
	11	10	16.80	3.47	15.80	3.25	14.80	3.03	13.90	2.82	12.90	2.61
	9	8	16.80	3.60	15.80	3.37	14.80	3.14	13.90	2.91	12.90	2.70
	7	6	16.80	3.77	15.80	3.52	14.80	3.28	13.90	3.05	12.90	2.82
	5	4	16.80	3.96	15.80	3.70	14.80	3.45	13.90	3.19	12.90	2.95
	3	2	16.80	4.12	15.80	3.85	14.80	3.58	13.90	3.31	12.90	3.06
	0	-1	16.80	4.40	15.80	4.10	14.80	3.81	13.90	3.53	12.90	3.26
	-3	-4	16.80	4.73	15.80	4.40	14.80	4.09	13.90	3.78	12.90	3.48
	-5	-6	16.30	4.99	15.80	4.85	14.80	4.50	13.90	4.16	12.90	3.82

10. Capacity Table

Heating

TC : Total Capacity, PI : Power Input

Combination, % (Capacity Index)	Outdoor temperature (°C)		Indoor temperature (°C, DB)									
			16		18		20		22		24	
	DB	WB	TC kW	PI kW	TC kW	PI kW	TC kW	PI kW	TC kW	PI kW	TC kW	PI kW
80	-7	-8	15.70	4.91	15.60	5.01	14.80	4.74	13.90	4.37	12.90	4.03
	-10	-11	14.40	4.95	14.40	5.06	14.40	5.17	13.90	5.00	12.90	4.59
	-12	-13	13.80	4.85	13.70	4.97	13.70	5.08	13.70	5.19	12.90	4.87
	-15	-16	13.10	4.73	13.10	4.86	13.00	4.98	13.00	5.10	12.90	5.19
	-17	-18	12.40	4.49	12.40	4.60	12.40	4.73	12.30	4.85	12.30	4.98
	-20	-21	11.30	4.28	11.30	4.41	11.30	4.54	11.20	4.68	11.20	4.81
	-15	14	14.60	2.80	13.80	2.62	13.00	2.46	12.20	2.29	11.30	2.13
70	13	12	14.60	2.89	13.80	2.71	13.00	2.53	12.20	2.36	11.30	2.19
	11	10	14.60	2.99	13.80	2.80	13.00	2.61	12.20	2.44	11.30	2.27
	9	8	14.60	3.09	13.80	2.90	13.00	2.71	12.20	2.52	11.30	2.34
	7	6	14.60	3.23	13.80	3.03	13.00	2.83	12.20	2.63	11.30	2.45
	5	4	14.60	3.39	13.80	3.17	13.00	2.97	12.20	2.75	11.30	2.56
	3	2	14.60	3.53	13.80	3.30	13.00	3.08	12.20	2.86	11.30	2.65
	0	-1	14.60	3.75	13.80	3.51	13.00	3.27	12.20	3.03	11.30	2.81
	-3	-4	14.60	4.03	13.80	3.76	13.00	3.50	12.20	3.25	11.30	3.00
	-5	-6	14.60	4.43	13.80	4.14	13.00	3.84	12.20	3.56	11.30	3.29
	-7	-8	14.60	4.67	13.80	4.35	13.00	4.05	12.20	3.75	11.30	3.45
	-10	-11	14.40	5.19	13.80	4.97	13.00	4.61	12.20	4.27	11.30	3.93
	-12	-13	13.70	5.10	13.70	5.20	13.00	4.90	12.20	4.52	11.30	4.15
	-15	-16	13.00	5.00	13.00	5.10	13.00	5.21	12.20	4.82	11.30	4.42
	-17	-18	12.40	4.75	12.30	4.86	12.30	4.97	12.20	5.00	11.30	4.59
	-20	-21	11.30	4.57	11.20	4.69	11.20	4.80	11.20	4.92	11.20	5.04
60	15	14	12.60	2.38	11.90	2.23	11.10	2.09	10.40	1.96	9.70	1.83
	13	12	12.60	2.45	11.90	2.30	11.10	2.16	10.40	2.02	9.70	1.88
	11	10	12.60	2.52	11.90	2.38	11.10	2.23	10.40	2.08	9.70	1.94
	9	8	12.60	2.61	11.90	2.45	11.10	2.30	10.40	2.15	9.70	2.00
	7	6	12.60	2.73	11.90	2.57	11.10	2.40	10.40	2.24	9.70	2.09
	5	4	12.60	2.86	11.90	2.68	11.10	2.51	10.40	2.34	9.70	2.17
	3	2	12.60	2.97	11.90	2.78	11.10	2.60	10.40	2.42	9.70	2.26
	0	-1	12.60	3.15	11.90	2.95	11.10	2.76	10.40	2.57	9.70	2.39
	-3	-4	12.60	3.37	11.90	3.15	11.10	2.94	10.40	2.73	9.70	2.54
	-5	-6	12.60	3.70	11.90	3.46	11.10	3.22	10.40	3.00	9.70	2.78
	-7	-8	12.60	3.89	11.90	3.64	11.10	3.39	10.40	3.15	9.70	2.91
	-10	-11	12.60	4.43	11.90	4.13	11.10	3.85	10.40	3.57	9.70	3.30
	-12	-13	12.60	4.70	11.90	4.39	11.10	4.08	10.40	3.78	9.70	3.49
	-15	-16	12.60	5.01	11.90	4.66	11.10	4.34	10.40	4.01	9.70	3.69
	-17	-18	12.30	5.03	11.90	4.85	11.10	4.51	10.40	4.16	9.70	3.83
-20	-21	11.20	4.87	11.20	4.97	11.10	5.02	10.40	4.62	9.70	4.26	
50	15	14	10.50	1.97	9.90	1.86	9.30	1.75	8.70	1.64	8.10	1.54
	13	12	10.50	2.03	9.90	1.92	9.30	1.80	8.70	1.69	8.10	1.58
	11	10	10.50	2.09	9.90	1.97	9.30	1.85	8.70	1.74	8.10	1.62
	9	8	10.50	2.16	9.90	2.04	9.30	1.91	8.70	1.79	8.10	1.68
	7	6	10.50	2.25	9.90	2.12	9.30	1.99	8.70	1.86	8.10	1.74
	5	4	10.50	2.35	9.90	2.22	9.30	2.08	8.70	1.95	8.10	1.82
	3	2	10.50	2.43	9.90	2.29	9.30	2.15	8.70	2.01	8.10	1.88
	0	-1	10.50	2.58	9.90	2.42	9.30	2.27	8.70	2.13	8.10	1.98
	-3	-4	10.50	2.75	9.90	2.58	9.30	2.42	8.70	2.26	8.10	2.10
	-5	-6	10.50	3.02	9.90	2.83	9.30	2.65	8.70	2.47	8.10	2.30
	-7	-8	10.50	3.17	9.90	2.97	9.30	2.77	8.70	2.59	8.10	2.40
	-10	-11	10.50	3.59	9.90	3.36	9.30	3.14	8.70	2.92	8.10	2.70
	-12	-13	10.50	3.80	9.90	3.55	9.30	3.32	8.70	3.08	8.10	2.86
	-15	-16	10.50	4.03	9.90	3.78	9.30	3.51	8.70	3.27	8.10	3.02
	-17	-18	10.50	4.19	9.90	3.91	9.30	3.64	8.70	3.37	8.10	3.12
-20	-21	10.50	4.65	9.90	4.35	9.30	4.04	8.70	3.74	8.10	3.44	

NOTE

- Capacity table may be subject to change without prior notice.
- Capacity table comply with EN14511.
- Cooling capacities are based on;
 - Indoor temperature : 27°C DB, 19°C WB
 - Outdoor temperature : 35°C DB, 24°C WB, Equivalent refrigerant piping : 7.5m, Level differences : 0m
- Heating capacities are based on;
 - Indoor temperature : 20°C DB, 15°C WB
 - Outdoor temperature : 7°C DB, 6°C WB, Equivalent refrigerant piping : 7.5m, Level differences : 0m

10. Capacity Table

AM080FXMDGH/EU

Cooling

TC : Total Capacity, PI : Power Input

Combination, % (Capacity index)	Outdoor temperature (°C, DB)	Indoor temperature (°C, WB)													
		14		16		18		19		20		22		24	
		TC kW	PI kW	TC kW	PI kW	TC kW	PI kW	TC kW	PI kW	TC kW	PI kW	TC kW	PI kW	TC kW	PI kW
130	10	19.30	2.53	24.10	3.26	26.80	3.57	28.50	3.96	28.20	4.14	29.40	4.26	30.50	4.28
	12	19.30	2.55	24.10	3.29	26.80	3.59	28.20	3.95	28.00	4.13	29.20	4.25	30.20	4.27
	14	19.30	2.59	24.10	3.34	26.80	3.65	27.90	3.97	27.70	4.15	28.90	4.27	29.90	4.29
	16	19.30	2.66	24.10	3.43	26.60	3.75	27.60	4.03	27.40	4.21	28.50	4.34	29.60	4.36
	18	19.30	2.77	24.10	3.57	26.30	3.87	27.20	4.15	27.00	4.33	28.10	4.46	29.20	4.48
	20	19.30	2.92	24.10	3.77	25.90	4.03	26.90	4.32	26.60	4.51	27.80	4.64	28.80	4.67
	21	19.30	3.02	24.10	3.89	25.70	4.13	26.70	4.43	26.50	4.62	27.60	4.76	28.60	4.78
	23	19.30	3.24	24.10	4.17	25.40	4.37	26.30	4.68	26.10	4.90	27.20	5.04	28.20	5.06
	25	19.30	3.50	23.80	4.51	25.10	4.66	26.00	5.00	25.80	5.22	26.90	5.37	27.80	5.40
	27	19.30	3.79	23.50	4.89	24.80	4.99	25.70	5.35	25.50	5.59	26.50	5.75	27.50	5.78
	29	19.30	4.11	23.20	5.30	24.50	5.34	25.40	5.73	25.10	5.98	26.20	6.16	27.20	6.19
	31	19.30	4.44	22.90	5.72	24.10	5.70	25.10	6.11	24.80	6.38	25.90	6.57	26.80	6.61
	33	19.20	4.76	22.60	6.15	23.80	6.04	24.70	6.47	24.50	6.76	25.50	6.96	26.50	7.00
	35	19.00	5.07	22.30	6.54	23.50	6.33	24.30	6.79	24.10	7.09	25.10	7.30	26.10	7.34
	37	18.60	5.34	21.90	6.89	23.00	6.55	23.90	7.02	23.70	7.33	24.70	7.54	25.60	7.58
	39	18.20	5.54	21.40	6.99	22.50	6.65	23.40	7.12	23.20	7.44	24.10	7.66	25.00	7.70
	42	17.40	5.60	20.40	6.82	21.50	6.48	22.30	6.95	22.10	7.26	23.10	7.47	23.90	7.51
	44	16.60	5.27	19.60	6.42	20.60	6.10	21.40	6.54	21.20	6.83	22.10	7.03	22.90	7.07
	46	15.70	4.69	18.50	5.72	19.50	5.44	20.20	5.82	20.00	6.09	20.90	6.26	21.60	6.30
	120	10	18.00	2.25	21.70	2.82	25.10	3.08	26.90	3.58	27.80	3.91	29.00	4.02	29.70
12		18.00	2.26	21.70	2.84	25.10	3.10	26.90	3.60	27.60	3.90	28.70	4.01	29.50	4.03
14		18.00	2.32	21.70	2.91	25.10	3.18	26.90	3.70	27.30	3.96	28.40	4.07	29.20	4.10
16		18.00	2.39	21.70	2.99	25.10	3.27	26.90	3.80	27.00	4.02	28.10	4.14	28.80	4.16
18		18.00	2.49	21.70	3.11	25.10	3.41	26.80	3.95	26.60	4.13	27.70	4.25	28.40	4.28
20		18.00	2.63	21.70	3.29	25.10	3.60	26.50	4.12	26.20	4.30	27.40	4.43	28.10	4.45
21		18.00	2.71	21.70	3.39	25.10	3.71	26.30	4.22	26.10	4.41	27.20	4.54	27.90	4.56
23		18.00	2.91	21.70	3.64	25.10	3.98	26.00	4.47	25.70	4.67	26.80	4.81	27.50	4.83
25		18.00	3.14	21.70	3.93	25.10	4.30	25.60	4.76	25.40	4.98	26.50	5.12	27.10	5.15
27		18.00	3.40	21.70	4.26	24.90	4.66	25.30	5.10	25.10	5.33	26.10	5.49	26.80	5.51
29		18.00	3.69	21.70	4.62	24.60	5.05	25.00	5.46	24.80	5.71	25.80	5.87	26.50	5.90
31		18.00	3.99	21.70	4.99	24.30	5.44	24.70	5.83	24.50	6.09	25.50	6.27	26.20	6.30
33		18.00	4.28	21.70	5.36	23.90	5.76	24.40	6.17	24.10	6.45	25.20	6.64	25.80	6.67
35		18.00	4.56	21.50	5.70	23.60	6.04	24.00	6.47	23.80	6.76	24.80	6.96	25.40	7.00
37		17.70	4.80	21.20	6.00	23.20	6.25	23.60	6.69	23.30	6.99	24.30	7.20	25.00	7.23
39		17.30	4.98	20.70	6.23	22.60	6.34	23.00	6.79	22.80	7.10	23.80	7.30	24.40	7.34
42		16.50	4.94	19.80	6.26	21.60	6.18	22.00	6.62	21.80	6.92	22.70	7.12	23.30	7.16
44		15.80	4.65	18.90	5.89	20.70	5.82	21.10	6.23	20.90	6.51	21.80	6.70	22.30	6.74
46		14.90	4.15	17.90	5.25	19.60	5.18	19.90	5.56	19.70	5.81	20.60	5.97	21.10	6.01
110		10	16.60	1.95	20.50	2.46	23.00	2.70	24.60	3.13	26.10	3.50	28.20	3.74	29.00
	12	16.60	1.97	20.50	2.48	23.00	2.71	24.60	3.15	26.10	3.52	28.20	3.74	28.80	3.76
	14	16.60	2.02	20.50	2.54	23.00	2.78	24.60	3.23	26.10	3.61	28.10	3.79	28.50	3.81
	16	16.60	2.07	20.50	2.61	23.00	2.86	24.60	3.32	26.10	3.71	27.70	3.85	28.10	3.87
	18	16.60	2.16	20.50	2.72	23.00	2.98	24.60	3.46	26.10	3.85	27.30	3.96	27.80	3.98
	20	16.60	2.28	20.50	2.87	23.00	3.15	24.60	3.65	26.10	4.01	27.00	4.12	27.40	4.15
	21	16.60	2.35	20.50	2.97	23.00	3.25	24.60	3.76	26.00	4.11	26.80	4.23	27.20	4.25
	23	16.60	2.52	20.50	3.18	23.00	3.48	24.60	4.04	25.60	4.35	26.40	4.47	26.80	4.50
	25	16.60	2.73	20.50	3.44	23.00	3.76	24.60	4.36	25.30	4.64	26.10	4.77	26.50	4.80
	27	16.60	2.96	20.50	3.73	23.00	4.08	24.60	4.73	25.00	4.96	25.80	5.11	26.20	5.13
	29	16.60	3.20	20.50	4.04	23.00	4.42	24.40	5.09	24.70	5.31	25.50	5.47	25.90	5.50
	31	16.60	3.46	20.50	4.36	23.00	4.78	24.10	5.43	24.40	5.67	25.10	5.83	25.50	5.87
	33	16.60	3.72	20.50	4.68	23.00	5.13	23.80	5.75	24.10	6.01	24.80	6.18	25.20	6.21
	35	16.60	3.96	20.50	4.99	23.00	5.46	23.40	6.03	23.70	6.30	24.40	6.48	24.80	6.52
	37	16.30	4.09	20.10	5.25	22.60	5.75	23.00	6.23	23.30	6.51	24.00	6.70	24.40	6.74
	39	15.90	4.15	19.60	5.45	22.10	5.90	22.50	6.32	22.80	6.61	23.50	6.80	23.80	6.84
	42	15.20	4.05	18.80	5.36	21.10	5.76	21.50	6.17	21.70	6.45	22.40	6.63	22.70	6.67
	44	14.60	3.81	18.00	5.04	20.20	5.42	20.60	5.80	20.80	6.06	21.50	6.24	21.80	6.27
	46	13.80	3.40	17.00	4.49	19.10	4.83	19.40	5.17	19.70	5.40	20.30	5.56	20.60	5.59
	100	10	15.90	1.70	18.60	2.16	21.40	2.66	22.40	2.85	24.30	3.13	26.20	3.38	28.10
12		15.90	1.71	18.60	2.17	21.40	2.68	22.40	2.87	24.30	3.15	26.20	3.40	28.10	3.57
14		15.90	1.74	18.60	2.20	21.40	2.72	22.40	2.92	24.30	3.20	26.20	3.45	28.10	3.62
16		15.90	1.79	18.60	2.26	21.40	2.80	22.40	3.00	24.30	3.29	26.20	3.55	27.70	3.68
18		15.90	1.86	18.60	2.36	21.40	2.92	22.40	3.12	24.30	3.43	26.20	3.69	27.40	3.78
20		15.90	1.97	18.60	2.49	21.40	3.08	22.40	3.30	24.30	3.62	26.20	3.90	27.00	3.93
21		15.90	2.03	18.60	2.57	21.40	3.18	22.40	3.40	24.30	3.73	26.20	4.01	26.80	4.03
23		15.90	2.18	18.60	2.76	21.40	3.41	22.40	3.65	24.30	4.00	25.80	4.25	26.50	4.27
25		15.90	2.35	18.60	2.98	21.40	3.68	22.40	3.94	24.30	4.33	25.50	4.53	26.10	4.55
27		15.90	2.55	18.60	3.23	21.40	3.99	22.40	4.27	24.30	4.69	25.20	4.85	25.80	4.87
29		15.90	2.76	18.60	3.50	21.40	4.32	22.40	4.63	24.10	5.04	24.90	5.19	25.50	5.22
31		15.90	2.99	18.60	3.78	21.40	4.67	22.40	5.00	23.80	5.38	24.50	5.54	25.20	5.57
33		15.90	3.21	18.60	4.06	21.40	5.02	22.40	5.37	23.50	5.70	24.20	5.87	24.80	5.90
35		15.90	3.41	18.60	4.32	21.40	5.34	22.40	5.72	23.10	5.98	23.90	6.15	24.50	6.18
37		15.60	3.53	18.30	4.47	21.00	5.52	22.00	5.91	22.70	6.18	23.40	6.36	24.00	6.39
39		15.20	3.58	17.90	4.53	20.50	5.60	21.50	6.00	22.20	6.27	22.90	6.45	23.50	6.49
42		14.50	3.49	17.10	4.42	19.60	5.46	20.50	5.85	21.20	6.12	21.90	6.30	22.40	6.33
44		13.90	3.29	16.40	4.16	18.80	5.14	19.70	5.51	20.30	5.76	20.90	5.92	21.50	5.96
46		13.20	2.93	15.50	3.71	17.70	4.58	18.60	4.91	19.20	5.13	19.80	5.28	20.30	5.31
90		10	14.70	1.36	17.30	1.72	19.90	2.13	20.80	2.28	22.00	2.44	23.80	2.84	26.00
	12	14.70	1.37	17.30	1.73	19.90	2.14	20.80	2.29	22.00	2.45	23.80	2.86	26.00	3.00
	14	14.70	1.39	17.30	1.76	19.90	2.18	20.80	2.33	22.00	2.49	23.80	2.90	26.00	3.05
	16	14.70	1.43	17.30	1.81	19.90	2.24	20.80	2.40	22.00	2.56	23.80	2.98	26.00	3.13
	18	14.70	1.49	17.30	1.88	19.90	2.33	20.80	2.50	22.00	2.67	23.80	3.11	26.00	3.26
	20	14.70	1.57	17.30	1.99	19.90	2.								

10. Capacity Table

Cooling

TC : Total Capacity, PI : Power Input

Combination, % (Capacity index)	Outdoor temperature (°C, DB)	Indoor temperature (°C, WB)															
		14		16		18		19		20		22		24			
		TC kW	PI kW	TC kW	PI kW	TC kW	PI kW	TC kW	PI kW	TC kW	PI kW	TC kW	PI kW	TC kW	PI kW		
90	37	14.50	2.82	17.00	3.57	19.50	4.41	20.40	4.72	21.10	4.94	21.80	5.49	22.80	5.62		
	39	14.20	2.86	16.60	3.62	19.10	4.47	20.00	4.79	20.60	5.01	21.30	5.57	22.30	5.70		
	42	13.50	2.79	15.90	3.53	18.20	4.11	19.10	4.68	19.70	4.89	20.30	5.43	21.30	5.56		
	44	12.90	2.63	15.20	3.32	17.40	4.11	18.30	4.40	18.90	4.60	19.50	5.11	20.40	5.23		
	46	12.20	2.34	14.40	2.96	16.50	3.66	17.30	3.92	17.80	4.10	18.40	4.56	19.20	4.66		
	10	13.20	1.14	15.60	1.45	17.90	1.79	18.70	1.91	19.70	1.96	21.90	2.42	24.60	2.67		
	12	13.20	1.15	15.60	1.45	17.90	1.80	18.70	1.93	19.70	1.97	21.90	2.43	24.60	2.69		
80	14	13.20	1.16	15.60	1.46	17.90	1.81	18.70	1.94	19.70	1.99	21.90	2.45	24.60	2.71		
	16	13.20	1.18	15.60	1.49	17.90	1.84	18.70	1.97	19.70	2.02	21.90	2.49	24.60	2.76		
	18	13.20	1.22	15.60	1.54	17.90	1.90	18.70	2.04	19.70	2.09	21.90	2.57	24.60	2.84		
	20	13.20	1.27	15.60	1.61	17.90	1.99	18.70	2.13	19.70	2.18	21.90	2.69	24.60	2.97		
	21	13.20	1.30	15.60	1.64	17.90	2.03	18.70	2.18	19.70	2.23	21.90	2.75	24.60	3.04		
	23	13.20	1.38	15.60	1.75	17.90	2.16	18.70	2.31	19.70	2.37	21.90	2.92	24.30	3.23		
	25	13.20	1.48	15.60	1.87	17.90	2.31	18.70	2.47	19.70	2.53	21.90	3.12	24.00	3.45		
	27	13.20	1.58	15.60	2.00	17.90	2.48	18.70	2.65	19.70	2.72	21.90	3.35	23.70	3.70		
	29	13.20	1.72	15.60	2.17	17.90	2.68	18.70	2.88	19.70	2.95	21.80	3.63	23.40	4.02		
	31	13.20	1.86	15.60	2.35	17.90	2.90	18.70	3.11	19.70	3.18	21.50	3.93	23.10	4.34		
	33	13.20	1.99	15.60	2.52	17.90	3.11	18.70	3.34	19.70	3.42	21.20	4.21	22.80	4.66		
	35	13.20	2.12	15.60	2.68	17.90	3.32	18.70	3.55	19.70	3.64	20.90	4.49	22.50	4.96		
	37	13.00	2.19	15.30	2.77	17.50	3.43	18.40	3.67	19.40	3.83	20.50	4.66	22.10	5.16		
	39	12.70	2.22	14.90	2.82	17.10	3.48	18.00	3.73	18.90	3.89	20.10	4.73	21.60	5.24		
	42	12.10	2.17	14.30	2.75	16.40	3.39	17.20	3.64	18.10	3.80	19.20	4.61	20.60	5.11		
	44	11.60	2.04	13.70	2.58	15.70	3.19	16.40	3.42	17.30	3.57	18.40	4.34	19.70	4.81		
	46	11.00	1.82	12.90	2.30	14.80	2.85	15.50	3.05	16.30	3.19	17.40	3.87	18.60	4.28		
70	10	11.50	0.91	13.50	1.16	15.50	1.43	16.30	1.53	17.30	1.55	19.40	1.83	21.70	2.07		
	12	11.50	0.92	13.50	1.16	15.50	1.44	16.30	1.54	17.30	1.56	19.40	1.84	21.70	2.08		
	14	11.50	0.93	13.50	1.17	15.50	1.45	16.30	1.55	17.30	1.57	19.40	1.85	21.70	2.09		
	16	11.50	0.94	13.50	1.19	15.50	1.48	16.30	1.58	17.30	1.60	19.40	1.89	21.70	2.13		
	18	11.50	0.97	13.50	1.23	15.50	1.52	16.30	1.63	17.30	1.66	19.40	1.95	21.70	2.20		
	20	11.50	1.01	13.50	1.28	15.50	1.58	16.30	1.69	17.30	1.72	19.40	2.02	21.70	2.28		
	21	11.50	1.03	13.50	1.31	15.50	1.61	16.30	1.73	17.30	1.75	19.40	2.06	21.70	2.33		
	23	11.50	1.09	13.50	1.37	15.50	1.70	16.30	1.82	17.30	1.85	19.40	2.17	21.70	2.46		
	25	11.50	1.14	13.50	1.44	15.50	1.78	16.30	1.91	17.30	1.94	19.40	2.28	21.70	2.58		
	27	11.50	1.21	13.50	1.53	15.50	1.89	16.30	2.03	17.30	2.06	19.40	2.42	21.50	2.74		
	29	11.50	1.31	13.50	1.66	15.50	2.05	16.30	2.20	17.30	2.23	19.40	2.63	21.30	2.97		
	31	11.50	1.42	13.50	1.80	15.50	2.22	16.30	2.38	17.30	2.41	19.40	2.84	21.00	3.21		
	33	11.50	1.52	13.50	1.93	15.50	2.38	16.30	2.55	17.30	2.59	19.30	3.05	20.70	3.45		
	35	11.50	1.62	13.50	2.05	15.50	2.54	16.30	2.72	17.30	2.76	19.00	3.24	20.40	3.67		
	37	11.30	1.68	13.30	2.12	15.20	2.62	16.00	2.81	17.00	2.90	18.70	3.41	20.10	3.86		
	39	11.00	1.70	13.00	2.15	14.90	2.66	15.60	2.85	16.60	2.98	18.30	3.54	19.60	4.01		
	42	10.50	1.66	12.40	2.10	14.20	2.59	14.90	2.78	15.80	2.91	17.50	3.59	18.70	4.06		
44	10.10	1.56	11.90	1.98	13.60	2.44	14.30	2.62	15.20	2.73	16.70	3.38	17.90	3.82			
60	46	9.50	1.39	11.20	1.76	12.90	2.18	13.50	2.33	14.30	2.44	15.80	3.01	16.90	3.40		
	10	9.70	0.73	11.40	0.92	13.10	1.13	13.80	1.22	14.90	1.21	16.60	1.45	18.40	1.61		
	12	9.70	0.72	11.40	0.92	13.10	1.13	13.80	1.21	14.90	1.21	16.60	1.44	18.40	1.61		
	14	9.70	0.73	11.40	0.92	13.10	1.14	13.80	1.22	14.90	1.22	16.60	1.45	18.20	1.64		
	16	9.70	0.74	11.40	0.94	13.10	1.16	13.80	1.24	14.90	1.24	16.60	1.48	18.40	1.65		
	18	9.70	0.77	11.40	0.97	13.10	1.20	13.80	1.29	14.90	1.28	16.60	1.53	18.40	1.71		
	20	9.70	0.80	11.40	1.02	13.10	1.26	13.80	1.35	14.90	1.34	16.60	1.60	18.40	1.79		
	21	9.70	0.82	11.40	1.04	13.10	1.28	13.80	1.38	14.90	1.37	16.60	1.64	18.40	1.83		
	23	9.70	0.84	11.40	1.07	13.10	1.32	13.80	1.41	14.90	1.40	16.60	1.68	18.40	1.87		
	25	9.70	0.88	11.40	1.12	13.10	1.38	13.80	1.48	14.90	1.47	16.60	1.76	18.40	1.97		
	27	9.70	0.91	11.40	1.16	13.10	1.43	13.80	1.53	14.90	1.52	16.60	1.82	18.40	2.03		
	29	9.70	0.99	11.40	1.25	13.10	1.55	13.80	1.66	14.90	1.65	16.60	1.97	18.40	2.20		
	31	9.70	1.07	11.40	1.35	13.10	1.67	13.80	1.79	14.90	1.78	16.60	2.13	18.20	2.38		
	33	9.70	1.15	11.40	1.45	13.10	1.80	13.80	1.92	14.90	1.91	16.60	2.29	18.00	2.55		
	35	9.70	1.22	11.40	1.55	13.10	1.91	13.80	2.05	14.90	2.04	16.60	2.44	17.70	2.72		
	37	9.60	1.26	11.20	1.60	12.90	1.98	13.50	2.12	14.60	2.14	16.30	2.56	17.40	2.86		
	39	9.40	1.28	11.00	1.62	12.60	2.00	13.20	2.15	14.30	2.23	15.90	2.66	17.00	2.97		
42	8.90	1.25	10.50	1.58	12.00	1.96	12.60	2.10	13.70	2.19	15.20	2.72	16.30	3.03			
44	8.60	1.18	10.00	1.49	11.50	1.84	12.10	1.97	13.10	2.06	14.50	2.65	15.60	2.98			
46	8.10	1.05	9.50	1.33	10.90	1.64	11.40	1.76	12.40	1.84	13.70	2.36	14.70	2.66			
50	10	8.30	0.52	9.70	0.66	11.10	0.82	11.70	0.88	12.70	0.87	14.30	1.07	15.40	1.19		
	12	8.30	0.52	9.70	0.66	11.10	0.82	11.70	0.88	12.70	0.87	14.30	1.06	15.40	1.19		
	14	8.30	0.53	9.70	0.67	11.10	0.82	11.70	0.88	12.70	0.88	14.30	1.07	15.40	1.20		
	16	8.30	0.54	9.70	0.68	11.10	0.84	11.70	0.90	12.70	0.89	14.30	1.09	15.40	1.22		
	18	8.30	0.55	9.70	0.70	11.10	0.87	11.70	0.93	12.70	0.92	14.30	1.13	15.40	1.26		
	20	8.30	0.58	9.70	0.73	11.10	0.91	11.70	0.97	12.70	0.97	14.30	1.18	15.40	1.32		
	21	8.30	0.59	9.70	0.75	11.10	0.93	11.70	0.99	12.70	0.99	14.30	1.21	15.40	1.35		
	23	8.30	0.60	9.70	0.76	11.10	0.94	11.70	1.01	12.70	1.00	14.30	1.23	15.40	1.37		
	25	8.30	0.63	9.70	0.80	11.10	0.99	11.70	1.06	12.70	1.06	14.30	1.29	15.40	1.44		
	27	8.30	0.65	9.70	0.83	11.10	1.02	11.70	1.09	12.70	1.09	14.30	1.33	15.40	1.49		
	29	8.30	0.71	9.70	0.90	11.10	1.11	11.70	1.19	12.70	1.18	14.30	1.44	15.40	1.61		
	31	8.30	0.77	9.70	0.97	11.10	1.20	11.70	1.28	12.70	1.28	14.30	1.56	15.40	1.74		
	33	8.30	0.82	9.70	1.04	11.10	1.28	11.70	1.38	12.70	1.37	14.30	1.67	15.40	1.87		
	35	8.30	0.87	9.70	1.11	11.10	1.37	11.70	1.47	12.70	1.46	14.30	1.78	15.30	1.99		
	37	8.10	0.90	9.50	1.14	10.90	1.41	11.50	1.51	12.40	1.53	14.00	1.87	15.00	2.10		
	39	7.90	0.92	9.30	1.16	10.70	1.43	11.20	1.54	12.20	1.59	13.70	1.95	14.70	2.18		
	42	7.60	0.90	8.90	1.13	10.20	1.40	10.70	1.50	11.60	1.57	13.10	1.99	14.00	2.22		
44	7.30	0.84	8.50	1.07	9.80	1.32	10.30	1.41	11.10	1.47	12.60	1.95	13.40	2.19			
46	6.90	0.75	8.10	0.95	9.20	1.17	9.70	1.26	10.50	1.31	11.90	1.76	12.70	2.04			

NOTE

- Capacity table may be subject to change without prior notice.
- Capacity table comply with EN14511.
- Cooling capacities are based on;
 - Indoor temperature : 27°C DB, 19°C WB
 - Outdoor temperature : 35°C DB, 24°C WB, Equivalent refrigerant piping :

10. Capacity Table

Heating

TC : Total Capacity, PI : Power Input

Combination, % (Capacity index)	Outdoor temperature (°C)		Indoor temperature (°C, DB)									
			16		18		20		22		24	
	DB	WB	TC kW	PI kW	TC kW	PI kW	TC kW	PI kW	TC kW	PI kW	TC kW	PI kW
130	15	14	34.40	4.89	33.80	4.93	31.80	4.82	31.40	4.92	31.00	5.01
	13	12	33.50	4.80	33.00	4.84	31.80	4.86	31.40	4.95	31.00	5.04
	11	10	32.60	4.75	32.10	4.80	31.10	4.85	30.80	4.94	30.40	5.03
	9	8	31.70	4.71	31.20	4.75	30.30	4.80	29.90	4.89	29.50	4.98
	7	6	30.80	4.67	30.40	4.71	29.50	4.75	29.10	4.85	28.70	4.94
	5	4	30.20	4.58	29.70	4.62	28.80	4.67	28.50	4.76	28.10	4.85
	3	2	28.90	4.49	28.50	4.53	27.60	4.57	27.30	4.66	26.90	4.75
	0	-1	28.10	4.40	27.60	4.44	26.80	4.48	26.50	4.57	26.20	4.66
	-3	-4	27.20	4.85	26.80	4.89	26.00	4.94	25.70	5.04	25.40	5.13
	-5	-6	26.40	4.80	26.00	4.85	25.30	4.89	25.00	4.99	24.60	5.08
	-7	-8	25.10	5.29	24.70	5.35	24.00	5.40	23.70	5.50	23.40	5.61
	-10	-11	23.50	5.28	23.10	5.33	22.40	5.38	22.10	5.49	21.90	5.59
	-12	-13	22.40	5.24	22.10	5.29	21.40	5.34	21.20	5.45	20.90	5.55
	-15	-16	20.90	5.21	20.60	5.26	20.00	5.31	19.80	5.41	19.50	5.51
	-17	-18	19.30	5.14	19.10	5.19	18.50	5.24	18.30	5.34	18.00	5.44
	-20	-21	17.80	5.06	17.50	5.11	17.00	5.16	16.80	5.25	16.60	5.35
120	15	14	33.10	4.96	31.90	5.00	30.40	4.77	30.00	4.86	29.70	4.95
	13	12	32.90	4.98	31.70	5.03	30.40	4.83	30.00	4.92	29.70	5.01
	11	10	32.00	4.88	30.90	4.93	30.40	4.85	30.00	4.95	29.70	5.04
	9	8	31.10	4.82	30.60	4.86	30.30	4.91	30.00	5.00	29.60	5.10
	7	6	30.60	4.79	29.50	4.83	28.90	4.88	28.90	4.97	28.50	5.07
	5	4	29.90	4.69	28.90	4.74	28.30	4.79	28.00	4.88	27.60	4.97
	3	2	28.70	4.60	27.70	4.65	27.10	4.69	26.80	4.78	26.40	4.87
	0	-1	27.80	4.51	26.90	4.55	26.30	4.60	26.00	4.69	25.70	4.78
	-3	-4	27.00	4.97	26.10	5.02	25.60	5.07	25.20	5.17	24.90	5.26
	-5	-6	26.20	4.92	25.30	4.97	24.80	5.02	24.50	5.12	24.20	5.21
	-7	-8	24.90	5.43	24.00	5.48	23.60	5.54	23.30	5.64	23.00	5.75
	-10	-11	23.30	5.41	22.40	5.47	22.00	5.52	21.70	5.63	21.50	5.73
	-12	-13	22.30	5.38	21.50	5.43	21.00	5.48	20.80	5.59	20.50	5.69
	-15	-16	20.80	5.34	20.00	5.39	19.60	5.44	19.40	5.55	19.20	5.65
	-17	-18	19.20	5.27	18.50	5.32	18.10	5.37	17.90	5.48	17.70	5.58
	-20	-21	17.70	5.19	17.00	5.24	16.70	5.29	16.50	5.39	16.30	5.49
110	15	14	30.70	4.77	29.00	4.43	27.30	4.43	26.90	4.51	26.60	4.60
	13	12	30.70	4.82	29.00	4.55	27.30	4.55	26.90	4.64	26.60	4.73
	11	10	30.70	4.92	29.00	4.68	27.30	4.68	26.90	4.77	26.60	4.86
	9	8	30.30	4.98	29.00	4.80	27.30	4.80	26.90	4.89	26.60	4.98
	7	6	29.80	4.90	29.00	4.95	27.30	4.95	26.90	5.04	26.60	5.14
	5	4	29.10	4.81	28.40	4.85	27.00	4.90	26.60	5.00	26.30	5.09
	3	2	27.90	4.71	27.20	4.76	25.80	4.81	25.50	4.90	25.20	4.99
	0	-1	27.40	4.62	26.40	4.66	25.10	4.71	24.80	4.80	24.50	4.89
	-3	-4	26.90	5.09	25.60	5.14	24.40	5.19	24.00	5.29	23.70	5.39
	-5	-6	26.10	5.04	24.90	5.09	23.60	5.14	23.30	5.24	23.00	5.34
	-7	-8	24.70	5.56	23.60	5.62	22.40	5.67	22.20	5.78	21.90	5.89
	-10	-11	23.10	5.54	22.10	5.60	21.00	5.65	20.70	5.76	20.40	5.87
	-12	-13	22.10	5.50	21.10	5.56	20.10	5.61	19.80	5.72	19.60	5.83
	-15	-16	20.60	5.47	19.70	5.52	18.70	5.58	18.50	5.68	18.20	5.79
	-17	-18	19.10	5.40	18.20	5.45	17.30	5.50	17.10	5.61	16.90	5.71
	-20	-21	17.50	5.31	16.70	5.36	15.90	5.42	15.70	5.52	15.50	5.62
100	15	14	28.10	4.46	26.60	4.25	25.00	4.29	24.70	4.37	24.40	4.46
	13	12	28.10	4.50	26.60	4.41	25.00	4.45	24.70	4.54	24.40	4.62
	11	10	28.10	4.67	26.60	4.58	25.00	4.62	24.70	4.71	24.40	4.80
	9	8	28.10	4.70	26.60	4.75	25.00	4.79	24.70	4.89	24.40	4.98
	7	6	28.10	4.79	26.60	4.83	25.00	4.88	24.70	4.97	24.40	5.07
	5	4	28.10	4.80	26.60	4.84	25.00	4.89	24.70	4.98	24.40	5.08
	3	2	28.00	4.89	26.40	4.93	24.90	4.98	24.60	5.08	24.30	5.17
	0	-1	27.20	4.79	25.70	4.84	24.20	4.88	23.90	4.98	23.60	5.07
	-3	-4	26.40	5.28	24.90	5.33	23.50	5.38	23.20	5.48	22.90	5.59
	-5	-6	25.60	5.23	24.20	5.28	22.80	5.33	22.50	5.43	22.20	5.54
	-7	-8	24.30	5.77	23.00	5.82	21.60	5.88	21.30	5.99	21.10	6.11
	-10	-11	22.70	5.75	21.50	5.81	20.20	5.86	19.90	5.97	19.70	6.09
	-12	-13	21.70	5.71	20.50	5.76	19.30	5.82	19.10	5.93	18.80	6.04
	-15	-16	20.30	5.67	19.10	5.73	18.00	5.78	17.80	5.89	17.60	6.00
	-17	-18	18.70	5.59	17.70	5.65	16.70	5.70	16.40	5.81	16.20	5.92
	-20	-21	17.20	5.51	16.30	5.56	15.30	5.62	15.10	5.72	14.90	5.83
90	15	14	25.50	4.02	24.10	3.96	22.70	3.92	22.40	3.99	22.10	4.07
	13	12	25.50	4.17	24.10	4.11	22.70	4.06	22.40	4.14	22.10	4.22
	11	10	25.50	4.33	24.10	4.26	22.70	4.22	22.40	4.30	22.10	4.38
	9	8	25.50	4.49	24.10	4.42	22.70	4.37	22.40	4.46	22.10	4.54
	7	6	25.50	4.57	24.10	4.50	22.70	4.45	22.40	4.54	22.10	4.62
	5	4	25.50	4.58	24.10	4.51	22.70	4.46	22.40	4.55	22.10	4.63
	3	2	25.50	4.69	24.10	4.62	22.70	4.57	22.40	4.66	22.10	4.74
	0	-1	25.50	4.73	24.10	4.66	22.70	4.61	22.40	4.70	22.10	4.79
	-3	-4	24.80	5.23	24.10	5.28	22.70	5.23	22.40	5.33	22.10	5.44
	-5	-6	24.10	5.18	23.30	5.23	22.40	5.28	22.10	5.38	21.90	5.48
	-7	-8	22.90	5.71	22.20	5.77	21.30	5.82	21.00	5.93	20.80	6.05
	-10	-11	21.60	5.69	20.90	5.75	20.10	5.80	19.80	5.92	19.60	6.03
	-12	-13	20.40	5.65	19.80	5.71	19.00	5.76	18.80	5.87	18.50	5.98
	-15	-16	19.10	5.61	18.50	5.67	17.80	5.72	17.50	5.83	17.30	5.95
	-17	-18	17.60	5.54	17.10	5.59	16.40	5.65	16.20	5.76	16.00	5.87
	-20	-21	16.20	5.45	15.70	5.51	15.10	5.56	14.90	5.67	14.70	5.77
80	15	14	22.70	3.58	21.40	3.50	20.10	3.46	19.90	3.53	19.60	3.60
	13	12	22.70	3.71	21.40	3.63	20.10	3.60	19.90	3.66	19.60	3.73
	11	10	22.70	3.85	21.40	3.77	20.10	3.73	19.90	3.80	19.60	3.87
	9	8	22.70	4.00	21.40	3.91	20.10	3.87	19.90	3.94	19.60	4.02
	7	6	22.70	4.07	21.40	3.98	20.10	3.94	19.90	4.02	19.60	4.09
	5	4	22.70	4.08	21.40	3.99	20.10	3.95	19.90	4.02	19.60	4.10
	3	2	22.70	4.17	21.40	4.09	20.10	4.04	19.90	4.12	19.60	4.20
	0	-1	22.70	4.21	21.40	4.12	20.10	4.08	19.90	4.16	19.60	4.24
	-3	-4	22.70	4.78	21.40	4.68	20.10	4.63	19.90	4.72	19.60	4.81
	-5	-6	22.70	4.88	21.40	4.78	20.10	4.73	19.90	4.82	19.60	4.91

10. Capacity Table

Heating

TC : Total Capacity, PI : Power Input

Combination, % (Capacity Index)	Outdoor temperature (°C)		Indoor temperature (°C, DB)									
			16		18		20		22		24	
	DB	WB	TC kW	PI kW	TC kW	PI kW	TC kW	PI kW	TC kW	PI kW	TC kW	PI kW
80	-7	-8	22.60	5.64	21.40	5.55	20.10	5.49	19.90	5.59	19.60	5.70
	-10	-11	21.30	5.62	20.70	5.68	19.90	5.73	19.70	5.84	19.40	5.95
	-12	-13	20.10	5.58	19.60	5.64	18.90	5.69	18.60	5.80	18.40	5.91
	-15	-16	18.80	5.55	18.30	5.60	17.60	5.66	17.40	5.76	17.20	5.87
	-17	-18	17.40	5.47	16.90	5.53	16.30	5.58	16.10	5.69	15.90	5.79
	-20	-21	16.00	5.39	15.60	5.44	15.00	5.49	14.80	5.60	14.60	5.70
	-21	-22	14.60	5.31	14.20	5.36	13.60	5.41	13.40	5.52	13.20	5.62
70	15	14	19.80	3.01	18.70	3.01	17.60	2.98	17.40	3.03	17.20	3.09
	13	12	19.80	3.12	18.70	3.12	17.60	3.09	17.40	3.15	17.20	3.21
	11	10	19.80	3.24	18.70	3.24	17.60	3.21	17.40	3.27	17.20	3.33
	9	8	19.80	3.36	18.70	3.36	17.60	3.33	17.40	3.39	17.20	3.45
	7	6	19.80	3.42	18.70	3.42	17.60	3.39	17.40	3.45	17.20	3.52
	5	4	19.80	3.43	18.70	3.43	17.60	3.39	17.40	3.46	17.20	3.52
	3	2	19.80	3.51	18.70	3.51	17.60	3.47	17.40	3.54	17.20	3.61
	0	-1	19.80	3.54	18.70	3.54	17.60	3.51	17.40	3.57	17.20	3.64
	-3	-4	19.80	4.02	18.70	4.02	17.60	3.98	17.40	4.06	17.20	4.13
	-5	-6	19.80	4.11	18.70	4.11	17.60	4.06	17.40	4.14	17.20	4.22
	-7	-8	19.80	4.77	18.70	4.77	17.60	4.72	17.40	4.81	17.20	4.90
	-10	-11	19.80	4.98	18.70	4.98	17.60	4.93	17.40	5.02	17.20	5.12
	-12	-13	19.80	5.28	18.70	5.28	17.60	5.23	17.40	5.33	17.20	5.43
	-15	-16	18.90	5.35	18.00	5.40	17.30	5.45	17.10	5.56	16.80	5.66
-17	-18	17.40	5.28	16.60	5.33	16.00	5.38	15.80	5.49	15.60	5.59	
-20	-21	16.00	5.20	15.30	5.25	14.70	5.30	14.50	5.40	14.30	5.50	
60	15	14	17.00	2.53	16.10	2.55	15.10	2.58	14.90	2.63	14.70	2.68
	13	12	17.00	2.62	16.10	2.65	15.10	2.67	14.90	2.73	14.70	2.78
	11	10	17.00	2.72	16.10	2.75	15.10	2.78	14.90	2.83	14.70	2.88
	9	8	17.00	2.82	16.10	2.85	15.10	2.88	14.90	2.93	14.70	2.99
	7	6	17.00	2.87	16.10	2.90	15.10	2.93	14.90	2.99	14.70	3.04
	5	4	17.00	2.88	16.10	2.91	15.10	2.94	14.90	2.99	14.70	3.05
	3	2	17.00	2.95	16.10	2.98	15.10	3.01	14.90	3.07	14.70	3.12
	0	-1	17.00	2.98	16.10	3.01	15.10	3.03	14.90	3.09	14.70	3.15
	-3	-4	17.00	3.38	16.10	3.41	15.10	3.45	14.90	3.51	14.70	3.58
	-5	-6	17.00	3.45	16.10	3.48	15.10	3.52	14.90	3.59	14.70	3.65
	-7	-8	17.00	4.01	16.10	4.04	15.10	4.08	14.90	4.16	14.70	4.24
	-10	-11	17.00	4.19	16.10	4.23	15.10	4.27	14.90	4.35	14.70	4.43
	-12	-13	17.00	4.44	16.10	4.48	15.10	4.53	14.90	4.61	14.70	4.70
	-15	-16	17.00	4.72	16.10	4.77	15.10	4.82	14.90	4.91	14.70	5.00
-17	-18	16.70	4.95	15.70	5.00	14.80	5.04	14.60	5.14	14.50	5.24	
-20	-21	15.30	4.87	14.50	4.92	13.60	4.97	13.50	5.06	13.30	5.16	
50	15	14	14.10	2.06	13.30	2.08	12.50	2.10	12.30	2.14	12.20	2.18
	13	12	14.10	2.14	13.30	2.16	12.50	2.18	12.30	2.22	12.20	2.26
	11	10	14.10	2.22	13.30	2.24	12.50	2.26	12.30	2.30	12.20	2.35
	9	8	14.10	2.30	13.30	2.32	12.50	2.34	12.30	2.39	12.20	2.44
	7	6	14.10	2.34	13.30	2.36	12.50	2.39	12.30	2.43	12.20	2.48
	5	4	14.10	2.35	13.30	2.37	12.50	2.39	12.30	2.44	12.20	2.48
	3	2	14.10	2.40	13.30	2.43	12.50	2.45	12.30	2.50	12.20	2.54
	0	-1	14.10	2.42	13.30	2.45	12.50	2.47	12.30	2.52	12.20	2.57
	-3	-4	14.10	2.75	13.30	2.78	12.50	2.81	12.30	2.86	12.20	2.91
	-5	-6	14.10	2.81	13.30	2.84	12.50	2.86	12.30	2.92	12.20	2.98
	-7	-8	14.10	3.26	13.30	3.29	12.50	3.33	12.30	3.39	12.20	3.45
	-10	-11	14.10	3.41	13.30	3.44	12.50	3.48	12.30	3.54	12.20	3.61
	-12	-13	14.10	3.61	13.30	3.65	12.50	3.69	12.30	3.76	12.20	3.83
	-15	-16	14.10	3.85	13.30	3.88	12.50	3.92	12.30	4.00	12.20	4.07
-17	-18	14.10	4.11	13.30	4.15	12.50	4.19	12.30	4.27	12.20	4.35	
-20	-21	13.80	4.32	13.00	4.36	12.30	4.40	12.10	4.49	12.00	4.57	

NOTE

- Capacity table may be subject to change without prior notice.
- Capacity table comply with EN14511.
- Cooling capacities are based on;
 - Indoor temperature : 27°C DB, 19°C WB
 - Outdoor temperature : 35°C DB, 24°C WB, Equivalent refrigerant piping : 7.5m, Level differences : 0m
- Heating capacities are based on;
 - Indoor temperature : 20°C DB, 15°C WB
 - Outdoor temperature : 7°C DB, 6°C WB, Equivalent refrigerant piping : 7.5m, Level differences : 0m

10. Capacity Table

AM080MXMDGH/EU

Cooling

TC : Total Capacity, PI : Power Input

Combination, % (Capacity index)	Outdoor temperature (°C, DB)	Indoor temperature (°C, WB)														
		14		16		18		19		20		22		24		
		TC kW	PI kW	TC kW	PI kW	TC kW	PI kW	TC kW	PI kW	TC kW	PI kW	TC kW	PI kW	TC kW	PI kW	
130	10	19.30	3.05	24.10	3.93	26.80	4.31	28.50	4.78	28.20	4.99	29.40	5.14	30.50	5.16	
	12	19.30	3.08	24.10	3.97	26.80	4.33	28.20	4.76	28.00	4.98	29.20	5.13	30.20	5.15	
	14	19.30	3.12	24.10	4.03	26.80	4.40	27.90	4.79	27.70	5.01	28.90	5.15	29.90	5.18	
	16	19.30	3.21	24.10	4.14	26.60	4.52	27.60	4.86	27.40	5.08	28.50	5.24	29.60	5.26	
	18	19.30	3.34	24.10	4.31	26.30	4.67	27.20	5.01	27.00	5.22	28.10	5.38	29.20	5.40	
	20	19.30	3.52	24.10	4.55	25.90	4.86	26.90	5.21	26.60	5.44	27.80	5.60	28.80	5.63	
	21	19.30	3.64	24.10	4.69	25.70	4.98	26.70	5.34	26.50	5.57	27.60	5.74	28.60	5.77	
	23	19.30	3.91	24.10	5.03	25.40	5.27	26.30	5.65	26.10	5.91	27.20	6.08	28.20	6.10	
	25	19.30	4.22	23.80	5.44	25.10	5.62	26.00	6.03	25.80	6.30	26.90	6.48	27.80	6.51	
	27	19.30	4.57	23.50	5.90	24.80	6.02	25.70	6.45	25.50	6.74	26.50	6.94	27.50	6.97	
	29	19.30	4.96	23.20	6.39	24.50	6.44	25.40	6.91	25.10	7.21	26.20	7.43	27.20	7.47	
	31	19.30	5.36	22.90	6.90	24.10	6.88	25.10	7.37	24.80	7.70	25.90	7.93	26.80	7.97	
	33	19.20	5.74	22.60	7.42	23.80	7.29	24.70	7.80	24.50	8.15	25.50	8.40	26.50	8.44	
	35	19.00	6.12	22.30	7.89	23.50	7.64	24.30	8.19	24.10	8.55	25.10	8.81	26.10	8.85	
	37	18.23	6.44	21.46	8.31	23.00	7.90	23.42	8.47	23.23	8.84	24.21	9.10	25.09	9.14	
	39	17.47	6.68	20.54	8.43	21.38	8.02	22.46	8.59	22.27	8.97	23.14	9.24	24.00	9.29	
	120	10	18.00	2.71	21.70	3.40	25.10	3.72	26.90	4.32	27.80	4.72	29.00	4.85	29.70	4.87
		12	18.00	2.73	21.70	3.43	25.10	3.74	26.90	4.34	27.60	4.70	28.70	4.84	29.50	4.86
14		18.00	2.80	21.70	3.51	25.10	3.84	26.90	4.46	27.30	4.78	28.40	4.91	29.20	4.95	
16		18.00	2.88	21.70	3.61	25.10	3.94	26.90	4.58	27.00	4.85	28.10	4.99	28.80	5.02	
18		18.00	3.00	21.70	3.75	25.10	4.11	26.80	4.76	26.60	4.98	27.70	5.13	28.40	5.16	
20		18.00	3.17	21.70	3.97	25.10	4.34	26.50	4.97	26.20	5.19	27.40	5.34	28.10	5.37	
21		18.00	3.27	21.70	4.09	25.10	4.48	26.30	5.09	26.10	5.32	27.20	5.48	27.90	5.50	
23		18.00	3.51	21.70	4.39	25.10	4.80	26.00	5.39	25.70	5.63	26.80	5.80	27.50	5.83	
25		18.00	3.79	21.70	4.74	25.10	5.19	25.60	5.74	25.40	6.01	26.50	6.18	27.10	6.21	
27		18.00	4.10	21.70	5.14	24.90	5.62	25.30	6.15	25.10	6.43	26.10	6.62	26.80	6.65	
29		18.00	4.45	21.70	5.57	24.60	6.09	25.00	6.59	24.80	6.89	25.80	7.08	26.50	7.12	
31		18.00	4.81	21.70	6.02	24.30	6.56	24.70	7.03	24.50	7.35	25.50	7.56	26.20	7.60	
33		18.00	5.16	21.70	6.47	23.90	6.95	24.40	7.44	24.10	7.78	25.20	8.01	25.80	8.05	
35		18.00	5.50	21.50	6.88	23.60	7.29	24.00	7.80	23.80	8.15	24.80	8.40	25.40	8.44	
37		17.35	5.79	20.78	7.24	23.20	7.54	23.13	8.07	22.83	8.43	23.81	8.69	24.50	8.72	
39		16.61	6.01	19.87	7.52	21.47	7.65	22.08	8.19	21.89	8.56	22.85	8.81	23.42	8.85	
110		10	16.60	2.35	20.50	2.97	23.00	3.26	24.60	3.78	26.10	4.22	28.20	4.51	29.00	4.54
		12	16.60	2.38	20.50	2.99	23.00	3.27	24.60	3.80	26.10	4.25	28.20	4.51	28.80	4.54
	14	16.60	2.44	20.50	3.06	23.00	3.35	24.60	3.90	26.10	4.35	28.10	4.57	28.50	4.60	
	16	16.60	2.50	20.50	3.15	23.00	3.45	24.60	4.00	26.10	4.48	27.70	4.64	28.10	4.67	
	18	16.60	2.61	20.50	3.28	23.00	3.59	24.60	4.17	26.10	4.64	27.30	4.78	27.80	4.80	
	20	16.60	2.75	20.50	3.46	23.00	3.80	24.60	4.40	26.10	4.84	27.00	4.97	27.40	5.01	
	21	16.60	2.83	20.50	3.58	23.00	3.92	24.60	4.54	26.00	4.96	26.80	5.10	27.20	5.13	
	23	16.60	3.04	20.50	3.84	23.00	4.20	24.60	4.87	25.60	5.25	26.40	5.39	26.80	5.43	
	25	16.60	3.29	20.50	4.15	23.00	4.54	24.60	5.26	25.30	5.60	26.10	5.75	26.50	5.79	
	27	16.60	3.57	20.50	4.50	23.00	4.92	24.60	5.71	25.00	5.98	25.80	6.16	26.20	6.19	
	29	16.60	3.86	20.50	4.87	23.00	5.33	24.40	6.14	24.70	6.41	25.50	6.60	25.90	6.63	
	31	16.60	4.17	20.50	5.26	23.00	5.77	24.10	6.55	24.40	6.84	25.10	7.03	25.50	7.08	
	33	16.60	4.49	20.50	5.65	23.00	6.19	23.80	6.94	24.10	7.25	24.80	7.45	25.20	7.49	
	35	16.60	4.78	20.50	6.02	23.00	6.59	23.40	7.27	23.70	7.60	24.40	7.82	24.80	7.87	
	37	15.97	4.93	19.70	6.33	22.60	6.94	22.54	7.52	22.83	7.85	23.52	8.08	23.91	8.13	
	39	15.26	5.01	18.82	6.57	21.00	7.12	21.60	7.62	21.89	7.97	22.56	8.20	22.85	8.25	
	100	10	15.90	2.05	18.60	2.61	21.40	3.21	22.40	3.44	24.30	3.78	26.20	4.08	28.10	4.28
		12	15.90	2.06	18.60	2.62	21.40	3.23	22.40	3.46	24.30	3.80	26.20	4.10	28.10	4.31
14		15.90	2.10	18.60	2.65	21.40	3.28	22.40	3.52	24.30	3.86	26.20	4.16	28.10	4.37	
16		15.90	2.16	18.60	2.73	21.40	3.38	22.40	3.62	24.30	3.97	26.20	4.28	27.70	4.44	
18		15.90	2.24	18.60	2.85	21.40	3.52	22.40	3.76	24.30	4.14	26.20	4.45	27.40	4.56	
20		15.90	2.38	18.60	3.00	21.40	3.72	22.40	3.98	24.30	4.37	26.20	4.70	27.00	4.74	
21		15.90	2.45	18.60	3.10	21.40	3.84	22.40	4.10	24.30	4.50	26.20	4.84	26.80	4.86	
23		15.90	2.63	18.60	3.33	21.40	4.11	22.40	4.40	24.30	4.83	25.80	5.13	26.50	5.15	
25		15.90	2.83	18.60	3.59	21.40	4.44	22.40	4.75	24.30	5.22	25.50	5.46	26.10	5.49	
27		15.90	3.08	18.60	3.90	21.40	4.81	22.40	5.15	24.30	5.66	25.20	5.85	25.80	5.87	
29		15.90	3.33	18.60	4.22	21.40	5.21	22.40	5.59	24.10	6.08	24.90	6.26	25.50	6.30	
31		15.90	3.61	18.60	4.56	21.40	5.63	22.40	6.03	23.80	6.49	24.50	6.68	25.20	6.72	
33		15.90	3.87	18.60	4.90	21.40	6.06	22.40	6.48	23.50	6.88	24.20	7.08	24.80	7.12	
35		15.90	4.11	18.60	5.21	21.40	6.44	22.40	6.90	23.10	7.21	23.90	7.42	24.50	7.45	
37		15.29	4.26	17.93	5.39	21.00	6.66	21.56	7.13	22.25	7.45	22.93	7.67	23.52	7.71	
39		14.59	4.32	17.18	5.46	19.48	6.76	20.64	7.24	21.31	7.56	21.98	7.78	22.56	7.83	

10. Capacity Table

Combination, % (Capacity index)	Outdoor temperature (°C, DB)	Indoor temperature (°C, WB)													
		14		16		18		19		20		22		24	
		TC kW	PI kW	TC kW	PI kW	TC kW	PI kW	TC kW	PI kW	TC kW	PI kW	TC kW	PI kW	TC kW	PI kW
90	10	14.70	1.64	17.30	2.07	19.90	2.57	20.80	2.75	22.00	2.94	23.80	3.43	26.00	3.59
	12	14.70	1.65	17.30	2.09	19.90	2.58	20.80	2.76	22.00	2.96	23.80	3.45	26.00	3.62
	14	14.70	1.68	17.30	2.12	19.90	2.63	20.80	2.81	22.00	3.00	23.80	3.50	26.00	3.68
	16	14.70	1.73	17.30	2.18	19.90	2.70	20.80	2.90	22.00	3.09	23.80	3.59	26.00	3.78
	18	14.70	1.80	17.30	2.27	19.90	2.81	20.80	3.02	22.00	3.22	23.80	3.75	26.00	3.93
	20	14.70	1.89	17.30	2.40	19.90	2.97	20.80	3.17	22.00	3.40	23.80	3.96	25.60	4.15
	21	14.70	1.95	17.30	2.47	19.90	3.06	20.80	3.28	22.00	3.51	23.80	4.09	25.40	4.27
	23	14.70	2.10	17.30	2.65	19.90	3.28	20.80	3.52	22.00	3.76	23.80	4.38	25.10	4.52
	25	14.70	2.27	17.30	2.87	19.90	3.55	20.80	3.80	22.00	4.07	23.70	4.72	24.80	4.83
	27	14.70	2.46	17.30	3.11	19.90	3.85	20.80	4.11	22.00	4.40	23.40	5.04	24.50	5.16
	29	14.70	2.67	17.30	3.38	19.90	4.16	20.80	4.46	22.00	4.78	23.10	5.40	24.20	5.54
	31	14.70	2.88	17.30	3.64	19.90	4.50	20.80	4.83	22.00	5.16	22.80	5.77	23.90	5.90
	33	14.70	3.09	17.30	3.91	19.90	4.84	20.80	5.18	21.80	5.49	22.50	6.10	23.60	6.25
	35	14.70	3.29	17.30	4.16	19.90	5.15	20.80	5.51	21.50	5.77	22.20	6.41	23.20	6.55
	37	14.21	3.40	16.66	4.31	19.50	5.32	19.99	5.69	20.68	5.96	21.36	6.62	22.34	6.78
	39	13.63	3.45	15.94	4.37	18.15	5.39	19.20	5.78	19.78	6.04	20.45	6.72	21.41	6.88
80	10	13.20	1.38	15.60	1.75	17.90	2.16	18.70	2.30	19.70	2.36	21.90	2.92	24.60	3.22
	12	13.20	1.39	15.60	1.75	17.90	2.17	18.70	2.33	19.70	2.38	21.90	2.93	24.60	3.24
	14	13.20	1.40	15.60	1.76	17.90	2.18	18.70	2.34	19.70	2.40	21.90	2.96	24.60	3.27
	16	13.20	1.42	15.60	1.80	17.90	2.22	18.70	2.38	19.70	2.44	21.90	3.00	24.60	3.33
	18	13.20	1.47	15.60	1.86	17.90	2.29	18.70	2.46	19.70	2.52	21.90	3.10	24.60	3.43
	20	13.20	1.53	15.60	1.94	17.90	2.40	18.70	2.57	19.70	2.63	21.90	3.24	24.60	3.58
	21	13.20	1.57	15.60	1.98	17.90	2.45	18.70	2.63	19.70	2.69	21.90	3.32	24.60	3.67
	23	13.20	1.66	15.60	2.11	17.90	2.61	18.70	2.79	19.70	2.86	21.90	3.52	24.30	3.90
	25	13.20	1.79	15.60	2.26	17.90	2.79	18.70	2.98	19.70	3.05	21.90	3.76	24.00	4.16
	27	13.20	1.91	15.60	2.41	17.90	2.99	18.70	3.20	19.70	3.28	21.90	4.04	23.70	4.46
	29	13.20	2.07	15.60	2.62	17.90	3.23	18.70	3.47	19.70	3.56	21.80	4.38	23.40	4.85
	31	13.20	2.24	15.60	2.83	17.90	3.50	18.70	3.75	19.70	3.84	21.50	4.74	23.10	5.24
	33	13.20	2.40	15.60	3.04	17.90	3.75	18.70	4.03	19.70	4.13	21.20	5.08	22.80	5.62
	35	13.20	2.56	15.60	3.23	17.90	4.00	18.70	4.28	19.70	4.39	20.90	5.42	22.50	5.98
	37	12.74	2.64	14.99	3.34	17.50	4.14	18.03	4.43	19.01	4.62	20.09	5.62	21.66	6.22
	39	12.19	2.68	14.30	3.40	16.25	4.20	17.28	4.50	18.14	4.69	19.30	5.71	20.74	6.32
70	10	11.50	1.10	13.50	1.40	15.50	1.73	16.30	1.85	17.30	1.87	19.40	2.21	21.70	2.50
	12	11.50	1.11	13.50	1.40	15.50	1.74	16.30	1.86	17.30	1.88	19.40	2.22	21.70	2.51
	14	11.50	1.12	13.50	1.41	15.50	1.75	16.30	1.87	17.30	1.89	19.40	2.23	21.70	2.52
	16	11.50	1.13	13.50	1.44	15.50	1.79	16.30	1.91	17.30	1.93	19.40	2.28	21.70	2.57
	18	11.50	1.17	13.50	1.48	15.50	1.83	16.30	1.97	17.30	2.00	19.40	2.35	21.70	2.65
	20	11.50	1.22	13.50	1.54	15.50	1.91	16.30	2.04	17.30	2.07	19.40	2.44	21.70	2.75
	21	11.50	1.24	13.50	1.58	15.50	1.94	16.30	2.09	17.30	2.11	19.40	2.48	21.70	2.81
	23	11.50	1.31	13.50	1.65	15.50	2.05	16.30	2.20	17.30	2.23	19.40	2.62	21.70	2.97
	25	11.50	1.38	13.50	1.74	15.50	2.15	16.30	2.30	17.30	2.34	19.40	2.75	21.70	3.11
	27	11.50	1.46	13.50	1.85	15.50	2.28	16.30	2.45	17.30	2.48	19.40	2.92	21.50	3.31
	29	11.50	1.58	13.50	2.00	15.50	2.47	16.30	2.65	17.30	2.69	19.40	3.17	21.30	3.58
	31	11.50	1.71	13.50	2.17	15.50	2.68	16.30	2.87	17.30	2.91	19.40	3.43	21.00	3.87
	33	11.50	1.83	13.50	2.33	15.50	2.87	16.30	3.08	17.30	3.12	19.30	3.68	20.70	4.16
	35	11.50	1.95	13.50	2.47	15.50	3.06	16.30	3.28	17.30	3.33	19.00	3.91	20.40	4.43
	37	11.07	2.03	13.03	2.56	15.20	3.16	15.68	3.39	16.66	3.50	18.33	4.11	19.70	4.66
	39	10.56	2.05	12.48	2.59	14.16	3.21	14.98	3.44	15.94	3.59	17.57	4.27	18.82	4.84
60	10	9.70	0.88	11.40	1.11	13.10	1.36	13.80	1.47	14.90	1.46	16.60	1.75	18.40	1.94
	12	9.70	0.87	11.40	1.11	13.10	1.36	13.80	1.46	14.90	1.46	16.60	1.74	18.40	1.94
	14	9.70	0.88	11.40	1.11	13.10	1.38	13.80	1.47	14.90	1.47	16.60	1.75	18.20	1.98
	16	9.70	0.89	11.40	1.13	13.10	1.40	13.80	1.50	14.90	1.50	16.60	1.79	18.40	1.99
	18	9.70	0.93	11.40	1.17	13.10	1.45	13.80	1.56	14.90	1.54	16.60	1.85	18.40	2.06
	20	9.70	0.97	11.40	1.23	13.10	1.52	13.80	1.63	14.90	1.62	16.60	1.93	18.40	2.16
	21	9.70	0.99	11.40	1.25	13.10	1.54	13.80	1.66	14.90	1.65	16.60	1.98	18.40	2.21
	23	9.70	1.01	11.40	1.29	13.10	1.59	13.80	1.70	14.90	1.69	16.60	2.03	18.40	2.26
	25	9.70	1.06	11.40	1.35	13.10	1.66	13.80	1.79	14.90	1.77	16.60	2.12	18.40	2.38
	27	9.70	1.10	11.40	1.40	13.10	1.73	13.80	1.85	14.90	1.83	16.60	2.20	18.40	2.45
	29	9.70	1.19	11.40	1.51	13.10	1.87	13.80	2.00	14.90	1.99	16.60	2.38	18.40	2.65
	31	9.70	1.29	11.40	1.63	13.10	2.01	13.80	2.16	14.90	2.15	16.60	2.57	18.20	2.87
	33	9.70	1.39	11.40	1.75	13.10	2.17	13.80	2.32	14.90	2.30	16.60	2.76	18.00	3.08
	35	9.70	1.47	11.40	1.87	13.10	2.30	13.80	2.47	14.90	2.46	16.60	2.94	17.70	3.28
	37	9.41	1.52	10.98	1.93	12.90	2.39	13.23	2.56	14.31	2.58	15.97	3.09	17.05	3.45
	39	9.02	1.54	10.56	1.95	11.97	2.41	12.67	2.59	13.73	2.69	15.26	3.21	16.32	3.58

10. Capacity Table

Combination, % (Capacity index)	Outdoor temperature (°C, DB)	Indoor temperature (°C, WB)													
		14		16		18		19		20		22		24	
		TC	PI	TC	PI	TC	PI	TC	PI	TC	PI	TC	PI	TC	PI
50	10	8.30	0.63	9.70	0.80	11.10	0.99	11.70	1.06	12.70	1.05	14.30	1.29	15.40	1.44
	12	8.30	0.63	9.70	0.80	11.10	0.99	11.70	1.06	12.70	1.05	14.30	1.28	15.40	1.44
	14	8.30	0.64	9.70	0.81	11.10	0.99	11.70	1.06	12.70	1.06	14.30	1.29	15.40	1.45
	16	8.30	0.65	9.70	0.82	11.10	1.01	11.70	1.09	12.70	1.07	14.30	1.31	15.40	1.47
	18	8.30	0.66	9.70	0.84	11.10	1.05	11.70	1.12	12.70	1.11	14.30	1.36	15.40	1.52
	20	8.30	0.70	9.70	0.88	11.10	1.10	11.70	1.17	12.70	1.17	14.30	1.42	15.40	1.59
	21	8.30	0.71	9.70	0.90	11.10	1.12	11.70	1.19	12.70	1.19	14.30	1.46	15.40	1.63
	23	8.30	0.72	9.70	0.92	11.10	1.13	11.70	1.22	12.70	1.21	14.30	1.48	15.40	1.65
	25	8.30	0.76	9.70	0.97	11.10	1.19	11.70	1.28	12.70	1.28	14.30	1.56	15.40	1.74
	27	8.30	0.78	9.70	1.00	11.10	1.23	11.70	1.31	12.70	1.31	14.30	1.60	15.40	1.80
	29	8.30	0.86	9.70	1.09	11.10	1.34	11.70	1.44	12.70	1.42	14.30	1.74	15.40	1.94
	31	8.30	0.93	9.70	1.17	11.10	1.45	11.70	1.54	12.70	1.54	14.30	1.88	15.40	2.10
	33	8.30	0.99	9.70	1.25	11.10	1.54	11.70	1.66	12.70	1.65	14.30	2.01	15.40	2.26
	35	8.30	1.05	9.70	1.34	11.10	1.65	11.70	1.77	12.70	1.76	14.30	2.15	15.30	2.40
	37	7.94	1.09	9.31	1.38	10.90	1.70	11.27	1.82	12.15	1.85	13.72	2.26	14.70	2.53
	39	7.58	1.11	8.93	1.40	10.17	1.73	10.75	1.86	11.71	1.92	13.15	2.35	14.11	2.63

NOTE

- Capacity table may be subject to change without prior notice.
- Capacity table comply with EN14511.
- Cooling capacities are based on;
 - Indoor temperature : 27°C DB, 19°C WB
 - Outdoor temperature : 35°C DB, 24°C WB, Equivalent refrigerant piping : 7.5m, Level differences : 0m
- Heating capacities are based on;
 - Indoor temperature : 20°C DB, 15°C WB
 - Outdoor temperature : 7°C DB, 6°C WB, Equivalent refrigerant piping : 7.5m, Level differences : 0m

10. Capacity Table

Heating

TC : Total Capacity, PI : Power Input

Combination, % (Capacity index)	Outdoor temperature (°C, DB)		Indoor temperature (°C, DB)									
			16		18		20		22		24	
			TC	PI	TC	PI	TC	PI	TC	PI	TC	PI
130	DB	WB	kW	kW	kW	kW	kW	kW	kW	kW	kW	kW
	15	14	30.82	5.81	30.28	5.86	28.49	5.73	28.13	5.85	27.78	5.95
	13	12	30.02	5.70	29.57	5.75	28.49	5.78	28.13	5.88	27.78	5.99
	11	10	29.21	5.65	28.76	5.70	27.87	5.76	27.60	5.87	27.24	5.98
	9	8	28.40	5.60	27.96	5.65	27.15	5.70	26.79	5.81	26.43	5.92
	7	6	27.60	5.55	27.24	5.60	26.43	5.65	26.07	5.76	25.72	5.87
	5	4	27.06	5.44	26.61	5.49	25.80	5.55	25.54	5.66	25.18	5.76
	3	2	25.89	5.34	25.54	5.38	24.73	5.43	24.46	5.54	24.10	5.65
	0	-1	25.18	5.23	24.73	5.28	24.01	5.32	23.74	5.43	23.48	5.54
	-3	-4	24.37	5.76	24.01	5.81	23.30	5.87	23.03	5.99	22.76	6.10
	-5	-6	23.65	5.70	23.30	5.76	22.67	5.81	22.40	5.93	22.04	6.04
	-7	-8	22.49	6.29	22.13	6.36	21.50	6.42	21.24	6.54	20.97	6.67
	-10	-11	21.06	6.28	20.70	6.33	20.07	6.39	19.80	6.53	19.62	6.64
	-12	-13	20.07	6.23	19.80	6.29	19.17	6.35	19.00	6.48	18.73	6.60
	-15	-16	18.73	6.19	18.46	6.25	17.92	6.31	17.74	6.43	17.47	6.55
	-17	-18	17.29	6.11	17.11	6.17	16.58	6.23	16.40	6.35	16.13	6.47
-20	-21	15.95	6.01	15.68	6.07	15.23	6.13	15.05	6.24	14.87	6.36	
120	15	14	29.66	5.90	28.58	5.94	27.24	5.67	26.88	5.78	26.61	5.88
	13	12	29.48	5.92	28.40	5.98	27.24	5.74	26.88	5.85	26.61	5.95
	11	10	28.67	5.80	27.69	5.86	27.24	5.76	26.88	5.88	26.61	5.99
	9	8	27.87	5.73	27.42	5.78	27.15	5.84	26.88	5.94	26.52	6.06
	7	6	27.42	5.69	26.43	5.74	25.89	5.80	25.89	5.91	25.54	6.03
	5	4	26.79	5.57	25.89	5.63	25.36	5.69	25.09	5.80	24.73	5.91
	3	2	25.72	5.47	24.82	5.53	24.28	5.57	24.01	5.68	23.65	5.79
	0	-1	24.91	5.36	24.10	5.41	23.56	5.47	23.30	5.57	23.03	5.68
	-3	-4	24.19	5.91	23.39	5.97	22.94	6.03	22.58	6.14	22.31	6.25
	-5	-6	23.48	5.85	22.67	5.91	22.22	5.97	21.95	6.09	21.68	6.19
	-7	-8	22.31	6.45	21.50	6.51	21.15	6.58	20.88	6.70	20.61	6.83
	-10	-11	20.88	6.43	20.07	6.50	19.71	6.56	19.44	6.69	19.26	6.81
	-12	-13	19.98	6.39	19.26	6.45	18.82	6.51	18.64	6.64	18.37	6.76
	-15	-16	18.64	6.35	17.92	6.41	17.56	6.47	17.38	6.60	17.20	6.72
	-17	-18	17.20	6.26	16.58	6.32	16.22	6.38	16.04	6.51	15.86	6.63
	-20	-21	15.86	6.17	15.23	6.23	14.96	6.29	14.78	6.41	14.60	6.53
110	15	14	27.51	5.67	25.98	5.27	24.46	5.27	24.10	5.36	23.83	5.47
	13	12	27.51	5.73	25.98	5.41	24.46	5.41	24.10	5.51	23.83	5.62
	11	10	27.51	5.85	25.98	5.56	24.46	5.56	24.10	5.67	23.83	5.78
	9	8	27.15	5.92	25.98	5.70	24.46	5.70	24.10	5.81	23.83	5.92
	7	6	26.70	5.82	25.98	5.88	24.46	5.88	24.10	5.99	23.83	6.11
	5	4	26.07	5.72	25.45	5.76	24.19	5.82	23.83	5.94	23.56	6.05
	3	2	25.00	5.60	24.37	5.66	23.12	5.72	22.85	5.82	22.58	5.93
	0	-1	24.55	5.49	23.65	5.54	22.49	5.60	22.22	5.70	21.95	5.81
	-3	-4	24.10	6.05	22.94	6.11	21.86	6.17	21.50	6.29	21.24	6.41
	-5	-6	23.39	5.99	22.31	6.05	21.15	6.11	20.88	6.23	20.61	6.35
	-7	-8	22.13	6.61	21.15	6.68	20.07	6.74	19.89	6.87	19.62	7.00
	-10	-11	20.70	6.58	19.80	6.66	18.82	6.72	18.55	6.85	18.28	6.98
	-12	-13	19.80	6.54	18.91	6.61	18.01	6.67	17.74	6.80	17.56	6.93
	-15	-16	18.46	6.50	17.65	6.56	16.76	6.63	16.58	6.75	16.31	6.88
	-17	-18	17.11	6.42	16.31	6.48	15.50	6.54	15.32	6.67	15.14	6.79
	-20	-21	15.68	6.31	14.96	6.37	14.25	6.44	14.07	6.56	13.89	6.68
100	15	14	25.18	5.30	23.83	5.05	22.40	5.10	22.13	5.19	21.86	5.30
	13	12	25.18	5.35	23.83	5.24	22.40	5.29	22.13	5.40	21.86	5.49
	11	10	25.18	5.55	23.83	5.44	22.40	5.49	22.13	5.60	21.86	5.70
	9	8	25.18	5.59	23.83	5.65	22.40	5.69	22.13	5.81	21.86	5.92
	7	6	25.18	5.69	23.83	5.74	22.40	5.80	22.13	5.91	21.86	6.03
	5	4	25.18	5.70	23.83	5.75	22.40	5.81	22.13	5.92	21.86	6.04
	3	2	25.09	5.81	23.65	5.86	22.31	5.92	22.04	6.04	21.77	6.14
	0	-1	24.37	5.69	23.03	5.75	21.68	5.80	21.41	5.92	21.15	6.03
	-3	-4	23.65	6.28	22.31	6.33	21.06	6.39	20.79	6.51	20.52	6.64
	-5	-6	22.94	6.22	21.68	6.28	20.43	6.33	20.16	6.45	19.89	6.58
	-7	-8	21.77	6.86	20.61	6.92	19.35	6.99	19.08	7.12	18.91	7.26
	-10	-11	20.34	6.83	19.26	6.91	18.10	6.96	17.83	7.10	17.65	7.24
	-12	-13	19.44	6.79	18.37	6.85	17.29	6.92	17.11	7.05	16.84	7.18
	-15	-16	18.19	6.74	17.11	6.81	16.13	6.87	15.95	7.00	15.77	7.13
	-17	-18	16.76	6.64	15.86	6.72	14.96	6.77	14.69	6.91	14.52	7.04
	-20	-21	15.41	6.55	14.60	6.61	13.71	6.68	13.53	6.80	13.35	6.93

10. Capacity Table

Combination, % (Capacity index)	Outdoor temperature (°C, DB)		Indoor temperature (°C, DB)									
			16		18		20		22		24	
			TC kW	PI kW	TC kW	PI kW	TC kW	PI kW	TC kW	PI kW	TC kW	PI kW
90	15	14	22.85	4.78	21.59	4.71	20.34	4.66	20.07	4.74	19.80	4.84
	13	12	22.85	4.96	21.59	4.88	20.34	4.83	20.07	4.92	19.80	5.02
	11	10	22.85	5.15	21.59	5.06	20.34	5.02	20.07	5.11	19.80	5.21
	9	8	22.85	5.34	21.59	5.25	20.34	5.19	20.07	5.30	19.80	5.40
	7	6	22.85	5.43	21.59	5.35	20.34	5.29	20.07	5.40	19.80	5.49
	5	4	22.85	5.44	21.59	5.36	20.34	5.30	20.07	5.41	19.80	5.50
	3	2	22.85	5.57	21.59	5.49	20.34	5.43	20.07	5.54	19.80	5.63
	0	-1	22.85	5.62	21.59	5.54	20.34	5.48	20.07	5.59	19.80	5.69
	-3	-4	22.22	6.22	21.59	6.28	20.34	6.22	20.07	6.33	19.80	6.47
	-5	-6	21.59	6.16	20.88	6.22	20.07	6.28	19.80	6.39	19.62	6.51
	-7	-8	20.52	6.79	19.89	6.86	19.08	6.92	18.82	7.05	18.64	7.19
	-10	-11	19.35	6.76	18.73	6.83	18.01	6.89	17.74	7.04	17.56	7.17
	-12	-13	18.28	6.72	17.74	6.79	17.02	6.85	16.84	6.98	16.58	7.11
	-15	-16	17.11	6.67	16.58	6.74	15.95	6.80	15.68	6.93	15.50	7.07
	-17	-18	15.77	6.58	15.32	6.64	14.69	6.72	14.52	6.85	14.34	6.98
	-20	-21	14.52	6.48	14.07	6.55	13.53	6.61	13.35	6.74	13.17	6.86
80	15	14	20.34	4.25	19.17	4.16	18.01	4.11	17.83	4.20	17.56	4.28
	13	12	20.34	4.41	19.17	4.31	18.01	4.28	17.83	4.35	17.56	4.43
	11	10	20.34	4.58	19.17	4.48	18.01	4.43	17.83	4.52	17.56	4.60
	9	8	20.34	4.75	19.17	4.65	18.01	4.60	17.83	4.68	17.56	4.78
	7	6	20.34	4.84	19.17	4.73	18.01	4.68	17.83	4.78	17.56	4.86
	5	4	20.34	4.85	19.17	4.74	18.01	4.69	17.83	4.78	17.56	4.87
	3	2	20.34	4.96	19.17	4.86	18.01	4.80	17.83	4.90	17.56	4.99
	0	-1	20.34	5.00	19.17	4.90	18.01	4.85	17.83	4.94	17.56	5.04
	-3	-4	20.34	5.68	19.17	5.56	18.01	5.50	17.83	5.61	17.56	5.72
	-5	-6	20.34	5.80	19.17	5.68	18.01	5.62	17.83	5.73	17.56	5.84
	-7	-8	20.25	6.70	19.17	6.60	18.01	6.53	17.83	6.64	17.56	6.77
	-10	-11	19.08	6.68	18.55	6.75	17.83	6.81	17.65	6.94	17.38	7.07
	-12	-13	18.01	6.63	17.56	6.70	16.93	6.76	16.67	6.89	16.49	7.02
	-15	-16	16.84	6.60	16.40	6.66	15.77	6.73	15.59	6.85	15.41	6.98
	-17	-18	15.59	6.50	15.14	6.57	14.60	6.63	14.43	6.76	14.25	6.88
	-20	-21	14.34	6.41	13.98	6.47	13.44	6.53	13.26	6.66	13.08	6.77
70	15	14	17.74	3.58	16.76	3.58	15.77	3.54	15.59	3.60	15.41	3.67
	13	12	17.74	3.71	16.76	3.71	15.77	3.67	15.59	3.74	15.41	3.82
	11	10	17.74	3.85	16.76	3.85	15.77	3.82	15.59	3.89	15.41	3.96
	9	8	17.74	3.99	16.76	3.99	15.77	3.96	15.59	4.03	15.41	4.10
	7	6	17.74	4.06	16.76	4.06	15.77	4.03	15.59	4.10	15.41	4.18
	5	4	17.74	4.08	16.76	4.08	15.77	4.03	15.59	4.11	15.41	4.18
	3	2	17.74	4.17	16.76	4.17	15.77	4.12	15.59	4.21	15.41	4.29
	0	-1	17.74	4.21	16.76	4.21	15.77	4.17	15.59	4.24	15.41	4.33
	-3	-4	17.74	4.78	16.76	4.78	15.77	4.73	15.59	4.83	15.41	4.91
	-5	-6	17.74	4.88	16.76	4.88	15.77	4.83	15.59	4.92	15.41	5.02
	-7	-8	17.74	5.67	16.76	5.67	15.77	5.61	15.59	5.72	15.41	5.82
	-10	-11	17.74	5.92	16.76	5.92	15.77	5.86	15.59	5.97	15.41	6.09
	-12	-13	17.74	6.28	16.76	6.28	15.77	6.22	15.59	6.33	15.41	6.45
	-15	-16	16.93	6.36	16.13	6.42	15.50	6.48	15.32	6.61	15.05	6.73
	-17	-18	15.59	6.28	14.87	6.33	14.34	6.39	14.16	6.53	13.98	6.64
	-20	-21	14.34	6.18	13.71	6.24	13.17	6.30	12.99	6.42	12.81	6.54
60	15	14	15.23	3.01	14.43	3.03	13.53	3.07	13.35	3.13	13.17	3.19
	13	12	15.23	3.11	14.43	3.15	13.53	3.17	13.35	3.24	13.17	3.30
	11	10	15.23	3.23	14.43	3.27	13.53	3.30	13.35	3.36	13.17	3.42
	9	8	15.23	3.35	14.43	3.39	13.53	3.42	13.35	3.48	13.17	3.55
	7	6	15.23	3.41	14.43	3.45	13.53	3.48	13.35	3.55	13.17	3.61
	5	4	15.23	3.42	14.43	3.46	13.53	3.49	13.35	3.55	13.17	3.63
	3	2	15.23	3.51	14.43	3.54	13.53	3.58	13.35	3.65	13.17	3.71
	0	-1	15.23	3.54	14.43	3.58	13.53	3.60	13.35	3.67	13.17	3.74
	-3	-4	15.23	4.02	14.43	4.05	13.53	4.10	13.35	4.17	13.17	4.25
	-5	-6	15.23	4.10	14.43	4.14	13.53	4.18	13.35	4.27	13.17	4.34
	-7	-8	15.23	4.77	14.43	4.80	13.53	4.85	13.35	4.94	13.17	5.04
	-10	-11	15.23	4.98	14.43	5.03	13.53	5.08	13.35	5.17	13.17	5.27
	-12	-13	15.23	5.28	14.43	5.32	13.53	5.38	13.35	5.48	13.17	5.59
	-15	-16	15.23	5.61	14.43	5.67	13.53	5.73	13.35	5.84	13.17	5.94
	-17	-18	14.96	5.88	14.07	5.94	13.26	5.99	13.08	6.11	12.99	6.23
	-20	-21	13.71	5.79	12.99	5.85	12.19	5.91	12.10	6.01	11.92	6.13

10. Capacity Table

Combination, % (Capacity index)	Outdoor temperature (°C, DB)		Indoor temperature (°C, DB)									
			16		18		20		22		24	
			TC	PI	TC	PI	TC	PI	TC	PI	TC	PI
50	DB	WB	kW	kW	kW	kW	kW	kW	kW	kW	kW	kW
	15	14	12.63	2.45	11.92	2.47	11.20	2.50	11.02	2.54	10.93	2.59
	13	12	12.63	2.54	11.92	2.57	11.20	2.59	11.02	2.64	10.93	2.69
	11	10	12.63	2.64	11.92	2.66	11.20	2.69	11.02	2.73	10.93	2.79
	9	8	12.63	2.73	11.92	2.76	11.20	2.78	11.02	2.84	10.93	2.90
	7	6	12.63	2.78	11.92	2.80	11.20	2.84	11.02	2.89	10.93	2.95
	5	4	12.63	2.79	11.92	2.82	11.20	2.84	11.02	2.90	10.93	2.95
	3	2	12.63	2.85	11.92	2.89	11.20	2.91	11.02	2.97	10.93	3.02
	0	-1	12.63	2.88	11.92	2.91	11.20	2.94	11.02	3.00	10.93	3.05
	-3	-4	12.63	3.27	11.92	3.30	11.20	3.34	11.02	3.40	10.93	3.46
	-5	-6	12.63	3.34	11.92	3.38	11.20	3.40	11.02	3.47	10.93	3.54
	-7	-8	12.63	3.87	11.92	3.91	11.20	3.96	11.02	4.03	10.93	4.10
	-10	-11	12.63	4.05	11.92	4.09	11.20	4.14	11.02	4.21	10.93	4.29
	-12	-13	12.63	4.29	11.92	4.34	11.20	4.39	11.02	4.47	10.93	4.55
	-15	-16	12.63	4.58	11.92	4.61	11.20	4.66	11.02	4.75	10.93	4.84
	-17	-18	12.63	4.88	11.92	4.93	11.20	4.98	11.02	5.08	10.93	5.17
-20	-21	12.36	5.13	11.65	5.18	11.02	5.23	10.84	5.34	10.75	5.43	

NOTE

- Capacity table may be subject to change without prior notice.
- Capacity table comply with EN14511.
- Cooling capacities are based on;
 - Indoor temperature : 27°C DB, 19°C WB
 - Outdoor temperature : 35°C DB, 24°C WB, Equivalent refrigerant piping : 7.5m, Level differences : 0m
- Heating capacities are based on;
 - Indoor temperature : 20°C DB, 15°C WB
 - Outdoor temperature : 7°C DB, 6°C WB, Equivalent refrigerant piping : 7.5m, Level differences : 0m

10. Capacity Table

AM100KXMDGH/EU

Cooling

TC : Total Capacity, PI : Power Input

Combination, % (Capacity index)	Outdoor Air Temp.	Indoor temperature														
		20 (°C, DB) 14 (°C, WB)		23 (°C, DB) 16 (°C, WB)		26 (°C, DB) 18 (°C, WB)		27 (°C, DB) 19 (°C, WB)		28 (°C, DB) 20 (°C, WB)		30 (°C, DB) 22 (°C, WB)		32 (°C, DB) 24 (°C, WB)		
		TC(kW)	PI(kW)	TC(kW)	PI(kW)	TC(kW)	PI(kW)	TC(kW)	PI(kW)	TC(kW)	PI(kW)	TC(kW)	PI(kW)	TC(kW)	PI(kW)	
130	10.0	25.90	3.22	30.90	3.81	36.00	4.37	38.40	4.61	41.10	4.94	44.10	5.23	48.00	5.64	
	12.0	25.70	3.29	30.60	3.90	35.70	4.49	38.10	4.73	40.70	5.07	43.80	5.38	47.60	5.82	
	14.0	25.40	3.38	30.40	4.00	35.50	4.60	37.80	4.85	40.40	5.20	43.40	5.53	47.20	6.00	
	16.0	25.20	3.48	30.10	4.11	35.10	4.76	37.40	5.02	40.00	5.35	43.00	5.71	46.70	6.19	
	18.0	24.90	3.57	29.80	4.23	34.70	4.92	37.00	5.17	39.60	5.50	42.60	5.86	46.30	6.38	
	20.0	24.60	3.69	29.40	4.39	34.30	5.10	36.60	5.35	39.10	5.69	42.10	6.07	45.70	6.62	
	21.0	24.50	3.79	29.20	4.52	34.10	5.24	36.30	5.50	38.90	5.83	41.80	6.23	45.40	6.80	
	23.0	24.20	4.03	28.80	4.81	33.70	5.55	35.90	5.82	38.40	6.17	41.30	6.59	44.80	7.20	
	25.0	23.80	4.26	28.40	5.07	33.20	5.84	35.30	6.11	37.80	6.48	40.60	6.91	44.10	7.56	
	27.0	23.50	4.57	28.00	5.44	32.70	6.25	34.80	6.54	37.30	6.91	40.00	7.38	43.50	8.07	
	29.0	23.00	4.88	27.50	5.80	32.10	6.65	34.20	6.94	36.60	7.32	39.30	7.81	42.70	8.53	
	31.0	22.70	5.21	27.00	6.18	31.60	7.08	33.60	7.39	36.00	7.77	38.70	8.29	42.00	9.06	
	33.0	22.20	5.53	26.50	6.53	30.90	7.47	32.90	7.77	35.20	8.17	37.90	8.70	41.20	9.51	
	35.0	21.70	5.83	25.90	6.86	30.30	7.83	32.30	8.15	34.50	8.54	37.10	9.07	40.30	9.91	
	37.0	21.30	6.09	25.40	7.16	29.60	8.17	31.60	8.50	33.80	8.89	36.30	9.44	39.50	10.30	
	39.0	20.80	6.18	24.80	7.41	28.90	8.44	30.80	8.76	33.00	9.16	35.40	9.68	38.50	10.56	
	120	10.0	24.30	3.12	28.90	3.69	33.80	4.26	35.90	4.52	38.10	4.77	40.60	5.00	42.40	5.18
		12.0	24.30	3.20	28.90	3.79	33.80	4.39	35.90	4.63	38.10	4.91	40.60	5.18	42.40	5.38
14.0		24.30	3.30	28.90	3.91	33.80	4.53	35.90	4.76	38.10	5.06	40.60	5.35	42.40	5.57	
16.0		24.30	3.39	28.90	4.02	33.80	4.66	35.90	4.91	38.10	5.21	40.60	5.50	42.40	5.75	
18.0		24.00	3.48	28.60	4.12	33.40	4.79	35.50	5.06	37.60	5.36	40.10	5.66	41.90	5.92	
20.0		23.70	3.60	28.20	4.28	33.00	4.98	35.30	5.27	37.20	5.55	39.60	5.88	41.40	6.15	
21.0		23.50	3.69	28.10	4.40	32.80	5.12	34.90	5.40	37.00	5.69	39.40	6.03	41.20	6.32	
23.0		23.20	3.89	27.70	4.63	32.30	5.39	34.40	5.66	36.40	5.96	38.80	6.32	40.60	6.62	
25.0		22.90	4.16	27.30	4.95	31.80	5.76	33.90	6.04	35.90	6.34	38.30	6.71	40.00	7.04	
27.0		22.50	4.44	26.80	5.28	31.30	6.13	33.30	6.41	35.30	6.71	37.60	7.11	39.30	7.48	
29.0		22.20	4.74	26.50	5.63	30.90	6.53	32.90	6.82	34.80	7.12	37.20	7.55	38.80	7.92	
31.0		21.80	5.06	26.00	6.01	30.40	6.95	32.30	7.23	34.20	7.54	36.50	7.99	38.10	8.39	
33.0		21.40	5.31	25.50	6.30	29.80	7.25	31.70	7.55	33.60	7.87	35.80	8.31	37.40	8.73	
35.0		21.00	5.58	25.00	6.61	29.20	7.60	31.10	7.89	32.90	8.20	35.10	8.64	36.70	9.08	
37.0		20.60	5.73	24.50	6.89	28.60	7.92	30.40	8.23	32.30	8.54	34.40	8.98	35.90	9.42	
39.0		20.10	5.97	24.00	7.13	28.00	8.21	29.80	8.51	31.60	8.82	33.70	9.25	35.20	9.70	
110		10.0	21.40	2.86	25.50	3.38	30.00	3.93	31.90	4.17	33.90	4.45	37.70	4.87	39.50	5.06
		12.0	21.40	2.94	25.50	3.47	30.00	4.04	31.90	4.27	33.90	4.56	37.70	5.01	39.50	5.25
	14.0	21.40	3.02	25.50	3.59	30.00	4.18	31.90	4.42	33.90	4.72	37.70	5.19	39.50	5.44	
	16.0	21.40	3.12	25.50	3.70	30.00	4.32	31.90	4.55	33.90	4.87	37.70	5.39	39.50	5.65	
	18.0	21.40	3.21	25.50	3.82	30.00	4.47	31.90	4.72	33.90	5.04	37.70	5.58	39.50	5.86	
	20.0	21.40	3.34	25.50	3.98	30.00	4.67	31.90	4.93	33.90	5.25	37.50	5.79	39.50	6.12	
	21.0	21.40	3.42	25.50	4.08	30.00	4.79	31.90	5.06	33.90	5.37	37.30	5.89	39.50	6.27	
	23.0	21.40	3.61	25.50	4.32	30.00	5.07	31.90	5.33	33.90	5.66	36.80	6.12	39.20	6.55	
	25.0	21.40	3.90	25.50	4.65	30.00	5.47	31.90	5.73	33.90	6.06	36.20	6.46	38.60	6.92	
	27.0	21.40	4.25	25.50	5.06	30.00	5.96	31.90	6.23	33.60	6.53	35.60	6.88	38.00	7.38	
	29.0	21.40	4.55	25.50	5.41	30.00	6.36	31.90	6.64	33.20	6.85	35.10	7.21	37.50	7.73	
	31.0	21.00	4.75	25.10	5.77	29.50	6.78	31.40	7.05	32.60	7.26	34.50	7.61	36.80	8.18	
	33.0	20.70	5.00	24.70	6.05	29.00	7.11	30.90	7.37	32.00	7.54	33.90	7.91	36.10	8.48	
	35.0	20.30	5.27	24.30	6.38	28.50	7.47	30.30	7.76	31.40	7.89	33.20	8.26	35.40	8.85	
	37.0	19.90	5.52	23.80	6.65	28.00	7.79	29.80	8.08	30.80	8.19	32.60	8.57	34.70	9.18	
	39.0	19.50	5.73	23.30	6.88	27.40	8.06	29.10	8.35	30.10	8.44	31.90	8.82	34.00	9.43	
	100	10.0	19.00	2.65	22.60	3.12	26.40	3.60	28.00	3.81	29.80	4.05	33.10	4.47	36.50	4.80
		12.0	19.00	2.72	22.60	3.21	26.40	3.70	28.00	3.91	29.80	4.16	33.10	4.62	36.50	4.99
14.0		19.00	2.82	22.60	3.34	26.40	3.85	28.00	4.06	29.80	4.32	33.10	4.81	36.50	5.23	
16.0		19.00	2.91	22.60	3.45	26.40	3.98	28.00	4.20	29.80	4.48	33.10	4.99	36.50	5.45	
18.0		19.00	3.01	22.60	3.57	26.40	4.12	28.00	4.35	29.80	4.64	33.10	5.17	36.50	5.67	
20.0		19.00	3.14	22.60	3.72	26.40	4.33	28.00	4.58	29.80	4.88	33.10	5.40	36.50	5.97	
21.0		19.00	3.17	22.60	3.83	26.40	4.46	28.00	4.71	29.80	5.02	33.10	5.55	36.50	6.15	
23.0		19.00	3.41	22.60	4.04	26.40	4.71	28.00	4.97	29.80	5.28	33.10	5.83	36.10	6.39	
25.0		19.00	3.62	22.60	4.30	26.40	5.01	28.00	5.29	29.80	5.60	33.10	6.18	35.60	6.68	
27.0		19.00	3.82	22.60	4.61	26.40	5.38	28.00	5.67	29.80	5.99	33.10	6.59	35.00	7.02	
29.0		19.00	4.07	22.60	4.92	26.40	5.74	28.00	6.04	29.80	6.35	33.10	6.99	34.50	7.34	
31.0		19.00	4.35	22.60	5.25	26.40	6.12	28.00	6.42	29.80	6.73	33.10	7.41	34.00	7.67	
33.0		19.00	4.65	22.60	5.61	26.40	6.54	28.00	6.86	29.80	7.12	32.80	7.77	33.50	8.01	
35.0		19.00	4.96	22.60	5.98	26.40	6.96	28.00	7.29	29.80	7.54	32.10	8.03	32.80	8.28	
37.0		19.00	5.33	22.60	6.41	26.40	7.44	27.70	7.60	29.40	7.96	31.40	8.38	32.00	8.60	
39.0		19.00	5.65	22.60	6.80	26.20	7.79	27.40	7.91	28.80	8.22	30.30	8.49	30.90	8.72	
90		10.0	17.30	2.18	20.70	2.62	24.20	3.04	25.50	3.18	27.20	3.40	30.30	3.76	33.40	4.12
		12.0	17.30	2.23	20.70	2.67	24.20	3.09	25.50	3.24	27.20	3.47	30.30	3.84	33.40	4.22
	14.0	17.30	2.28	20.70	2.74	24.20	3.17	25.50	3.32	27.20	3.55	30.30	3.93	33.40	4.33	
	16.0	17.30	2.35	20.70	2.77	24.20	3.28	25.50	3.42	27.20	3.65	30.30	4.05	33.40	4.46	
	18.0	17.30	2.42	20.70	2.84	24.20	3.37	25.50	3.52	27.20	3.74	30.30	4.16	33.40	4.63	
	20.0	17.30	2.51	20.70	2.95	24.20	3.46	25.50	3.65	27.20	3.90	30.30	4.37	33.40	4.85	
	21.0	17.30	2.56	20.70	3.01	24.20	3.54	25.50	3.75	27.20	4.01	30.30	4.49	33.40	4.97	
	23.0	17.30	2.67	20.70	3.15	24.20	3.78	25.50	3.95	27.20	4.21	30.30	4.73	33.40	5.21	
	25.0	17.30	2.82	20.70	3.34	24.20	3.99	25.50	4.18	27.20	4.44	30.30	4.99	33.40	5.50	
	27.0	17.30	3.01	20.70	3.56	24.20	4.27	25.50	4.47	27.20	4.75	30.30	5.32	33.40	5.86	
	29.0	17.30	3.21	20.70	3.81	24.20	4.56	25.50	4.76	27.20	5.05	30.30	5.66	33.40	6.22	
	31.0	17.30	3.43	20.70	4.06	24.20	4.86	25.50	5.06	27.20	5.37	30.30	5.96	33.40	6.58	
	33.0	17.30	3.66	20.70	4.33	24.20	5.18	25.50	5.39	27.20	5.70	30.30	6.30	33.40	6.97	
	35.0	17.30	3.91	20.70	4.62	24.20	5.52	25.50	5.75	27.20	6.06	30.30	6.67	32.70	7.21	
	37.0	17.30	4.20	20.70	4.95	24.20	5.92	25.50	6.12	27.20	6.46	30.30	7.08	31.90	7.48	
	39.0	17.30	4.51	20.70	5.31	24.20	6.29	25.50	6.54	27.20	6.89	29				

10. Capacity Table

Cooling

TC : Total Capacity, PI : Power Input

Combination, % (Capacity index)	Outdoor Air Temp.	Indoor temperature														
		20 (°C, DB) 14 (°C, WB)		23 (°C, DB) 16 (°C, WB)		26 (°C, DB) 18 (°C, WB)		27 (°C, DB) 19 (°C, WB)		28 (°C, DB) 20 (°C, WB)		30 (°C, DB) 22 (°C, WB)		32 (°C, DB) 24 (°C, WB)		
		TC(kW)	PI(kW)	TC(kW)	PI(kW)	TC(kW)	PI(kW)	TC(kW)	PI(kW)	TC(kW)	PI(kW)	TC(kW)	PI(kW)	TC(kW)	PI(kW)	
80	10.0	15.70	1.92	18.60	2.26	21.70	2.59	22.70	2.70	24.30	2.89	27.10	3.22	30.00	3.50	
	12.0	15.70	1.96	18.60	2.29	21.70	2.64	22.70	2.75	24.30	2.94	27.10	3.27	30.00	3.57	
	14.0	15.70	1.99	18.60	2.33	21.70	2.67	22.70	2.79	24.30	2.98	27.10	3.32	30.00	3.64	
	16.0	15.70	2.05	18.60	2.40	21.70	2.76	22.70	2.87	24.30	3.08	27.10	3.43	30.00	3.76	
	18.0	15.70	2.11	18.60	2.46	21.70	2.84	22.70	2.95	24.30	3.15	27.10	3.52	30.00	3.87	
	20.0	15.70	2.19	18.60	2.56	21.70	2.96	22.70	3.05	24.30	3.26	27.10	3.66	30.00	4.06	
	21.0	15.70	2.23	18.60	2.60	21.70	3.01	22.70	3.11	24.30	3.33	27.10	3.75	30.00	4.16	
	23.0	15.70	2.27	18.60	2.70	21.70	3.14	22.70	3.27	24.30	3.49	27.10	3.92	30.00	4.38	
	25.0	15.70	2.37	18.60	2.85	21.70	3.30	22.70	3.43	24.30	3.66	27.10	4.11	30.00	4.59	
	27.0	15.70	2.53	18.60	3.04	21.70	3.53	22.70	3.66	24.30	3.89	27.10	4.37	30.00	4.89	
	29.0	15.70	2.70	18.60	3.25	21.70	3.76	22.70	3.90	24.30	4.15	27.10	4.66	30.00	5.21	
	31.0	15.70	2.88	18.60	3.45	21.70	4.01	22.70	4.15	24.30	4.40	27.10	4.93	30.00	5.49	
	33.0	15.70	3.07	18.60	3.68	21.70	4.27	22.70	4.41	24.30	4.67	27.10	5.22	30.00	5.79	
	35.0	15.70	3.29	18.60	3.93	21.70	4.56	22.70	4.71	24.30	4.98	27.10	5.54	30.00	6.13	
	37.0	15.70	3.50	18.60	4.19	21.70	4.86	22.70	5.00	24.30	5.29	27.10	5.86	30.00	6.47	
	39.0	15.70	3.80	18.60	4.44	21.70	5.25	22.70	5.40	24.30	5.72	27.10	6.30	30.00	6.96	
	70	10.0	13.90	1.62	16.50	1.89	19.10	2.15	19.90	2.25	21.40	2.41	23.80	2.66	26.60	2.93
		12.0	13.90	1.67	16.50	1.95	19.10	2.22	19.90	2.29	21.40	2.48	23.80	2.74	26.60	3.02
		14.0	13.90	1.71	16.50	1.98	19.10	2.27	19.90	2.34	21.40	2.53	23.80	2.80	26.60	3.10
16.0		13.90	1.77	16.50	2.06	19.10	2.35	19.90	2.41	21.40	2.62	23.80	2.91	26.60	3.22	
18.0		13.90	1.83	16.50	2.12	19.10	2.43	19.90	2.48	21.40	2.69	23.80	3.00	26.60	3.33	
20.0		13.90	1.88	16.50	2.20	19.10	2.51	19.90	2.56	21.40	2.78	23.80	3.09	26.60	3.46	
21.0		13.90	1.93	16.50	2.24	19.10	2.56	19.90	2.61	21.40	2.83	23.80	3.16	26.60	3.55	
23.0		13.90	1.96	16.50	2.33	19.10	2.65	19.90	2.73	21.40	2.95	23.80	3.31	26.60	3.71	
25.0		13.90	2.02	16.50	2.41	19.10	2.78	19.90	2.86	21.40	3.07	23.80	3.45	26.60	3.87	
27.0		13.90	2.13	16.50	2.55	19.10	2.94	19.90	3.02	21.40	3.24	23.80	3.64	26.60	4.08	
29.0		13.90	2.24	16.50	2.66	19.10	3.06	19.90	3.20	21.40	3.37	23.80	3.78	26.60	4.25	
31.0		13.90	2.37	16.50	2.82	19.10	3.24	19.90	3.40	21.40	3.56	23.80	4.00	26.60	4.48	
33.0		13.90	2.52	16.50	3.00	19.10	3.46	19.90	3.60	21.40	3.78	23.80	4.24	26.60	4.74	
35.0		13.90	2.70	16.50	3.21	19.10	3.69	19.90	3.84	21.40	4.03	23.80	4.51	26.60	5.04	
37.0		13.90	2.92	16.50	3.47	19.10	3.99	19.90	4.08	21.40	4.35	23.80	4.85	26.60	5.41	
39.0		13.90	3.15	16.50	3.66	19.10	4.29	19.90	4.41	21.40	4.67	23.80	5.21	26.60	5.77	
60		10.0	12.10	1.38	14.30	1.60	16.60	1.82	17.10	1.87	18.50	2.02	20.70	2.24	23.20	2.47
		12.0	12.10	1.42	14.30	1.64	16.60	1.86	17.10	1.91	18.50	2.08	20.70	2.30	23.20	2.54
		14.0	12.10	1.44	14.30	1.67	16.60	1.91	17.10	1.95	18.50	2.12	20.70	2.36	23.20	2.61
	16.0	12.10	1.50	14.30	1.74	16.60	1.97	17.10	2.01	18.50	2.18	20.70	2.43	23.20	2.69	
	18.0	12.10	1.55	14.30	1.79	16.60	2.03	17.10	2.07	18.50	2.25	20.70	2.51	23.20	2.79	
	20.0	12.10	1.60	14.30	1.85	16.60	2.10	17.10	2.13	18.50	2.32	20.70	2.58	23.20	2.88	
	21.0	12.10	1.62	14.30	1.88	16.60	2.15	17.10	2.17	18.50	2.36	20.70	2.64	23.20	2.94	
	23.0	12.10	1.66	14.30	1.96	16.60	2.23	17.10	2.27	18.50	2.46	20.70	2.76	23.20	3.09	
	25.0	12.10	1.72	14.30	1.99	16.60	2.32	17.10	2.37	18.50	2.56	20.70	2.87	23.20	3.23	
	27.0	12.10	1.80	14.30	2.13	16.60	2.44	17.10	2.49	18.50	2.68	20.70	3.02	23.20	3.40	
	29.0	12.10	1.89	14.30	2.24	16.60	2.57	17.10	2.63	18.50	2.81	20.70	3.16	23.20	3.56	
	31.0	12.10	2.00	14.30	2.37	16.60	2.71	17.10	2.79	18.50	2.98	20.70	3.33	23.20	3.76	
	33.0	12.10	2.12	14.30	2.51	16.60	2.88	17.10	2.94	18.50	3.14	20.70	3.51	23.20	3.96	
	35.0	12.10	2.27	14.30	2.69	16.60	3.08	17.10	3.15	18.50	3.34	20.70	3.74	23.20	4.21	
	37.0	12.10	2.44	14.30	2.82	16.60	3.30	17.10	3.34	18.50	3.57	20.70	4.00	23.20	4.50	
	39.0	12.10	2.64	14.30	3.04	16.60	3.55	17.10	3.61	18.50	3.85	20.70	4.30	23.20	4.83	
	50	10.0	10.30	1.13	12.10	1.31	14.00	1.48	14.30	1.50	15.70	1.65	17.50	1.83	19.80	2.02
		12.0	10.30	1.16	12.10	1.34	14.00	1.51	14.30	1.54	15.70	1.69	17.50	1.88	19.80	2.07
		14.0	10.30	1.19	12.10	1.37	14.00	1.55	14.30	1.57	15.70	1.72	17.50	1.92	19.80	2.12
16.0		10.30	1.22	12.10	1.41	14.00	1.60	14.30	1.61	15.70	1.77	17.50	1.97	19.80	2.19	
18.0		10.30	1.26	12.10	1.46	14.00	1.65	14.30	1.67	15.70	1.82	17.50	2.04	19.80	2.27	
20.0		10.30	1.30	12.10	1.50	14.00	1.70	14.30	1.71	15.70	1.88	17.50	2.10	19.80	2.34	
21.0		10.30	1.33	12.10	1.53	14.00	1.74	14.30	1.75	15.70	1.91	17.50	2.14	19.80	2.39	
23.0		10.30	1.39	12.10	1.60	14.00	1.81	14.30	1.82	15.70	1.99	17.50	2.23	19.80	2.49	
25.0		10.30	1.41	12.10	1.66	14.00	1.88	14.30	1.89	15.70	2.07	17.50	2.33	19.80	2.61	
27.0		10.30	1.47	12.10	1.69	14.00	1.97	14.30	1.98	15.70	2.16	17.50	2.44	19.80	2.73	
29.0		10.30	1.54	12.10	1.82	14.00	2.07	14.30	2.08	15.70	2.27	17.50	2.56	19.80	2.88	
31.0		10.30	1.64	12.10	1.89	14.00	2.21	14.30	2.21	15.70	2.41	17.50	2.70	19.80	3.04	
33.0		10.30	1.73	12.10	2.03	14.00	2.31	14.30	2.32	15.70	2.53	17.50	2.83	19.80	3.19	
35.0		10.30	1.85	12.10	2.13	14.00	2.47	14.30	2.48	15.70	2.69	17.50	3.02	19.80	3.39	
37.0		10.30	1.97	12.10	2.26	14.00	2.63	14.30	2.63	15.70	2.86	17.50	3.20	19.80	3.60	
39.0		10.30	2.13	12.10	2.45	14.00	2.84	14.30	2.84	15.70	3.08	17.50	3.44	19.80	3.87	

10. Capacity Table

Heating

TC : Total Capacity, PI : Power Input

Combination, % (Capacity index)	Outdoor Air Temp.		Indoor temperature										
			16 (°C, DB)		18 (°C, DB)		20 (°C, DB)		22 (°C, DB)		24 (°C, DB)		
	DB	WB	TC(kW)	PI(kW)	TC(kW)	PI(kW)	TC(kW)	PI(kW)	TC(kW)	PI(kW)	TC(kW)	PI(kW)	
130	15.0	14.0	43.20	6.48	40.70	6.31	38.20	6.24	36.40	6.31	34.90	6.48	
	13.0	12.0	43.10	6.63	40.60	6.47	38.20	6.40	36.40	6.48	34.90	6.65	
	11.0	10.0	43.10	6.82	40.70	6.65	38.20	6.58	36.40	6.66	34.90	6.83	
	9.0	8.0	43.20	7.16	40.70	6.98	38.20	6.90	36.40	6.99	34.90	7.17	
	7.0	6.0	43.20	7.59	40.70	7.40	38.20	7.31	36.40	7.40	34.90	7.60	
	5.0	4.0	42.50	7.79	40.50	7.64	38.10	7.61	36.50	7.76	34.90	7.93	
	3.0	2.0	42.00	7.94	40.00	7.85	38.00	7.90	36.50	8.07	34.90	8.25	
	0.0	-1.0	41.30	8.30	39.30	8.38	38.20	8.61	36.50	8.73	35.00	8.96	
	-3.0	-4.0	40.60	9.16	38.70	9.22	37.30	9.45	36.30	10.02	34.60	10.28	
	-5.0	-6.0	40.10	9.86	38.10	9.77	36.40	9.85	35.60	10.70	34.10	11.29	
	-7.0	-8.0	39.20	10.10	37.20	10.10	35.20	10.07	34.60	11.04	33.30	11.47	
	-10.0	-11.0	37.70	10.18	36.10	10.18	34.10	10.15	33.30	10.83	32.30	11.32	
	-12.0	-13.0	36.70	10.33	35.20	10.24	33.30	10.21	32.50	11.09	31.50	11.39	
	-15.0	-16.0	35.30	10.09	33.90	10.02	32.50	10.12	31.90	11.01	30.80	11.38	
	-17.0	-18.0	33.80	9.91	32.90	9.98	31.70	10.13	30.90	11.05	29.70	11.48	
	-20.0	-21.0	32.00	9.69	31.40	9.84	30.80	10.17	30.10	10.99	28.80	11.37	
	-22.0	-23.0	30.00	9.47	29.30	9.60	28.60	9.92	27.90	10.72	26.70	11.12	
	-25.0	-26.0	27.00	9.12	26.20	9.22	25.50	9.49	24.90	10.26	23.80	10.70	
	120	15.0	14.0	40.90	6.36	38.40	6.18	35.90	6.08	34.20	6.16	32.70	6.30
		13.0	12.0	41.00	6.56	38.40	6.36	35.90	6.26	34.20	6.34	32.70	6.49
11.0		10.0	40.80	6.76	38.40	6.57	35.90	6.48	34.20	6.56	32.70	6.71	
9.0		8.0	40.90	7.10	38.40	6.89	35.90	6.80	34.20	6.88	32.70	7.04	
7.0		6.0	40.90	7.50	38.40	7.28	35.90	7.18	34.20	7.27	32.70	7.44	
5.0		4.0	40.90	7.77	38.40	7.55	35.90	7.45	34.40	7.57	32.70	7.72	
3.0		2.0	40.10	7.98	38.00	7.81	35.80	7.77	34.40	7.92	32.70	8.07	
0.0		-1.0	39.30	8.39	37.60	8.32	36.00	8.39	34.30	8.48	32.80	8.68	
-3.0		-4.0	38.40	8.95	36.80	9.04	35.90	9.30	34.30	9.45	32.80	9.66	
-5.0		-6.0	37.20	9.56	35.90	9.64	35.00	9.90	34.00	10.52	32.80	10.76	
-7.0		-8.0	36.10	9.95	35.00	9.99	34.00	10.21	33.20	10.59	32.30	11.40	
-10.0		-11.0	35.20	10.27	34.10	10.28	33.30	10.47	32.50	10.85	31.90	11.38	
-12.0		-13.0	34.10	10.28	33.30	10.30	32.50	10.53	31.80	10.71	30.60	11.35	
-15.0		-16.0	33.30	10.12	32.40	10.27	31.80	10.56	30.80	10.74	29.20	11.01	
-17.0		-18.0	32.60	10.02	31.70	10.25	30.80	10.65	29.70	10.79	28.30	11.12	
-20.0		-21.0	31.50	9.79	30.70	10.05	29.90	10.50	28.90	10.70	27.50	10.98	
-22.0		-23.0	29.60	9.59	28.70	9.82	27.80	10.26	26.90	10.45	25.60	10.75	
-25.0		-26.0	26.80	9.25	25.80	9.45	24.80	9.84	24.10	10.04	22.90	10.38	
110		15.0	14.0	39.30	6.25	36.80	6.06	34.40	5.96	32.70	6.02	31.20	6.15
		13.0	12.0	39.30	6.45	36.90	6.25	34.40	6.15	32.70	6.21	31.20	6.34
	11.0	10.0	39.30	6.70	36.90	6.49	34.40	6.39	32.70	6.45	31.20	6.59	
	9.0	8.0	39.30	7.03	36.90	6.81	34.40	6.70	32.70	6.77	31.20	6.91	
	7.0	6.0	39.30	7.41	36.90	7.18	34.40	7.06	32.70	7.13	31.20	7.28	
	5.0	4.0	39.20	7.63	36.70	7.39	34.30	7.27	32.80	7.40	31.20	7.52	
	3.0	2.0	38.80	7.91	36.50	7.71	34.30	7.63	32.90	7.77	31.20	7.89	
	0.0	-1.0	38.00	8.04	36.20	8.04	34.50	8.19	32.70	8.27	31.20	8.44	
	-3.0	-4.0	37.10	8.49	35.50	8.62	34.30	8.91	32.70	9.03	31.20	9.22	
	-5.0	-6.0	36.20	9.01	34.80	9.18	33.70	9.52	32.70	10.02	31.20	10.22	
	-7.0	-8.0	34.90	9.37	34.00	9.58	33.10	9.97	32.20	10.97	30.60	10.92	
	-10.0	-11.0	33.70	9.81	33.00	10.15	32.30	10.75	30.90	10.73	29.80	10.96	
	-12.0	-13.0	32.90	9.93	32.10	10.22	31.40	10.74	29.90	10.89	28.60	10.90	
	-15.0	-16.0	31.70	9.91	31.10	10.25	30.50	10.73	28.70	10.42	27.90	10.72	
	-17.0	-18.0	30.70	9.83	30.10	10.22	29.60	10.77	28.00	10.50	27.00	10.74	
	-20.0	-21.0	29.80	9.87	29.30	10.15	28.60	10.64	27.00	10.36	26.20	10.66	
	-22.0	-23.0	27.80	9.62	27.30	9.88	26.50	10.33	25.00	10.07	24.30	10.39	
	-25.0	-26.0	25.00	9.21	24.30	9.43	23.40	9.83	22.10	9.59	21.50	9.94	
	100	15.0	14.0	36.40	5.99	34.00	5.77	31.50	5.65	29.90	5.70	28.40	5.79
		13.0	12.0	36.40	6.20	34.00	5.98	31.50	5.85	29.90	5.90	28.40	6.00
11.0		10.0	36.40	6.49	34.00	6.26	31.50	6.12	29.90	6.17	28.40	6.27	
9.0		8.0	36.40	6.80	34.00	6.56	31.50	6.41	29.90	6.47	28.40	6.58	
7.0		6.0	36.40	7.15	34.00	6.89	31.50	6.74	29.90	6.80	28.40	6.91	
5.0		4.0	36.40	7.33	34.00	7.07	31.50	6.92	29.90	6.98	28.40	7.09	
3.0		2.0	36.40	7.74	34.00	7.46	31.50	7.30	29.90	7.37	28.40	7.48	
0.0		-1.0	36.10	8.13	33.80	7.87	31.50	7.72	29.90	7.80	28.40	7.92	
-3.0		-4.0	35.30	8.42	33.40	8.24	31.50	8.20	29.90	8.28	28.40	8.41	
-5.0		-6.0	34.10	8.85	32.90	8.87	31.50	9.04	29.90	9.13	28.40	9.27	
-7.0		-8.0	32.90	9.07	32.10	9.25	31.10	9.63	29.50	10.02	28.00	10.18	
-10.0		-11.0	31.60	9.23	31.00	9.74	30.50	10.46	28.60	10.20	26.90	10.37	
-12.0		-13.0	30.70	9.62	30.20	10.09	29.80	10.79	28.00	10.48	26.10	10.54	
-15.0		-16.0	30.10	9.82	29.90	10.28	29.30	10.97	27.40	10.60	25.50	10.55	
-17.0		-18.0	29.60	9.94	29.10	10.30	28.60	10.89	26.70	10.63	24.90	10.58	
-20.0		-21.0	28.70	10.24	28.00	10.42	27.30	10.81	25.70	10.64	23.90	10.58	
-22.0		-23.0	26.70	10.00	25.90	10.16	25.10	10.52	23.60	10.36	22.00	10.34	
-25.0		-26.0	23.60	9.59	22.80	9.72	21.90	10.03	20.60	9.89	19.20	9.93	

10. Capacity Table

Heating

TC : Total Capacity, PI : Power Input

Combination, % (Capacity index)	Outdoor Air Temp.		Indoor temperature										
			16 (°C, DB)		18 (°C, DB)		20 (°C, DB)		22 (°C, DB)		24 (°C, DB)		
	DB	WB	TC(kW)	PI(kW)	TC(kW)	PI(kW)	TC(kW)	PI(kW)	TC(kW)	PI(kW)	TC(kW)	PI(kW)	
90	15.0	14.0	32.80	5.47	30.60	5.28	28.40	5.16	26.90	5.21	25.60	5.29	
	13.0	12.0	32.80	5.66	30.60	5.46	28.40	5.34	26.90	5.39	25.60	5.47	
	11.0	10.0	32.80	5.87	30.60	5.67	28.40	5.54	26.90	5.59	25.60	5.68	
	9.0	8.0	32.80	6.16	30.60	5.94	28.40	5.81	26.90	5.87	25.60	5.96	
	7.0	6.0	32.80	6.47	30.60	6.24	28.40	6.11	26.90	6.16	25.60	6.26	
	5.0	4.0	32.80	6.73	30.60	6.49	28.40	6.35	26.90	6.41	25.60	6.51	
	3.0	2.0	32.80	7.04	30.60	6.79	28.40	6.64	26.90	6.71	25.60	6.81	
	0.0	-1.0	32.80	7.51	30.60	7.25	28.40	7.09	26.90	7.15	25.60	7.27	
	-3.0	-4.0	32.80	8.00	30.60	7.72	28.40	7.55	26.90	7.62	25.60	7.74	
	-5.0	-6.0	31.90	8.17	29.90	8.10	28.40	8.17	26.90	8.24	25.60	8.38	
	-7.0	-8.0	30.90	8.29	29.30	8.44	28.30	8.77	26.90	8.85	25.50	8.99	
	-10.0	-11.0	29.40	8.39	28.60	8.83	27.40	9.43	26.70	8.88	25.40	9.03	
	-12.0	-13.0	28.70	8.59	27.90	9.08	26.90	9.73	26.00	9.10	24.70	9.25	
	-15.0	-16.0	28.10	8.88	27.20	9.31	26.20	9.90	25.30	8.98	24.00	9.13	
	-17.0	-18.0	27.50	9.11	26.70	9.54	25.80	10.16	24.60	9.09	23.30	9.24	
	-20.0	-21.0	26.50	9.36	25.90	9.75	25.30	10.34	23.70	9.36	22.60	9.29	
	-22.0	-23.0	24.50	9.09	23.90	9.45	23.20	10.01	21.70	9.06	20.70	9.02	
	-25.0	-26.0	21.60	8.65	20.90	8.96	20.10	9.45	18.90	8.57	18.00	8.57	
	80	15.0	14.0	29.10	4.96	27.20	4.78	25.20	4.68	23.90	4.72	22.70	4.80
		13.0	12.0	29.10	5.12	27.20	4.94	25.20	4.83	23.90	4.87	22.70	4.95
		11.0	10.0	29.10	5.26	27.20	5.08	25.20	4.96	23.90	5.01	22.70	5.09
		9.0	8.0	29.10	5.52	27.20	5.33	25.20	5.21	23.90	5.26	22.70	5.34
		7.0	6.0	29.10	5.80	27.20	5.59	25.20	5.47	23.90	5.52	22.70	5.61
		5.0	4.0	29.10	6.13	27.20	5.92	25.20	5.78	23.90	5.84	22.70	5.93
		3.0	2.0	29.10	6.35	27.20	6.13	25.20	5.99	23.90	6.05	22.70	6.14
0.0		-1.0	29.10	6.84	27.20	6.60	25.20	6.45	23.90	6.51	22.70	6.62	
-3.0		-4.0	29.10	7.11	27.20	6.93	25.20	6.89	23.90	6.96	22.70	7.07	
-5.0		-6.0	28.90	7.23	26.70	7.19	25.20	7.29	23.90	7.36	22.70	7.48	
-7.0		-8.0	28.20	7.27	26.30	7.39	25.10	7.63	23.90	7.70	22.70	7.82	
-10.0		-11.0	27.20	7.48	25.70	7.60	24.70	7.84	23.50	7.92	22.30	8.04	
-12.0		-13.0	26.30	7.58	25.00	7.77	24.10	8.10	23.10	8.18	22.20	8.31	
-15.0		-16.0	25.40	7.94	24.50	8.05	23.50	8.33	22.50	8.22	21.60	8.35	
-17.0		-18.0	24.70	8.11	23.90	8.25	23.00	8.56	22.10	8.49	21.00	8.62	
-20.0		-21.0	23.80	8.27	23.00	8.45	22.30	8.79	21.20	8.40	20.20	8.54	
-22.0		-23.0	22.00	8.04	21.20	8.19	20.40	8.51	19.50	8.14	18.50	8.29	
-25.0		-26.0	19.40	7.65	18.60	7.77	17.70	8.04	16.90	7.70	16.00	7.87	
70		15.0	14.0	25.50	4.35	23.80	4.19	22.10	4.10	20.90	4.14	19.90	4.20
		13.0	12.0	25.50	4.47	23.80	4.31	22.10	4.22	20.90	4.26	19.90	4.33
		11.0	10.0	25.50	4.59	23.80	4.43	22.10	4.33	20.90	4.37	19.90	4.44
		9.0	8.0	25.50	4.79	23.80	4.62	22.10	4.51	20.90	4.56	19.90	4.63
		7.0	6.0	25.50	5.01	23.80	4.83	22.10	4.72	20.90	4.77	19.90	4.85
		5.0	4.0	25.50	5.28	23.80	5.09	22.10	4.98	20.90	5.03	19.90	5.11
		3.0	2.0	25.50	5.48	23.80	5.29	22.10	5.17	20.90	5.22	19.90	5.30
	0.0	-1.0	25.50	5.88	23.80	5.67	22.10	5.55	20.90	5.60	19.90	5.69	
	-3.0	-4.0	25.50	6.27	23.80	6.05	22.10	5.92	20.90	5.97	19.90	6.07	
	-5.0	-6.0	25.00	6.52	23.70	6.36	22.10	6.29	20.90	6.35	19.90	6.45	
	-7.0	-8.0	24.60	6.65	23.50	6.59	22.00	6.63	20.90	6.69	19.80	6.80	
	-10.0	-11.0	24.10	6.77	23.10	6.84	21.90	6.99	20.80	7.05	19.80	7.17	
	-12.0	-13.0	23.70	7.02	22.90	7.10	21.80	7.26	21.00	7.64	19.90	7.58	
	-15.0	-16.0	23.40	7.23	22.60	7.41	21.70	7.73	21.00	7.80	20.00	7.93	
	-17.0	-18.0	23.10	7.54	22.30	7.72	21.60	8.06	20.50	8.14	19.50	8.27	
	-20.0	-21.0	22.40	7.66	21.70	7.84	20.90	8.18	20.00	8.26	18.80	8.39	
	-22.0	-23.0	20.70	7.10	20.00	7.58	19.10	7.89	18.30	7.93	17.10	8.04	
	-25.0	-26.0	18.20	7.02	17.50	7.14	16.60	7.41	15.70	7.38	14.50	7.45	
	60	15.0	14.0	21.80	3.73	20.40	3.60	18.90	3.52	18.00	3.56	17.10	3.61
		13.0	12.0	21.80	3.83	20.40	3.69	18.90	3.61	18.00	3.64	17.10	3.70
		11.0	10.0	21.80	3.92	20.40	3.79	18.90	3.70	18.00	3.74	17.10	3.80
		9.0	8.0	21.80	4.05	20.40	3.91	18.90	3.82	18.00	3.86	17.10	3.92
		7.0	6.0	21.80	4.23	20.40	4.08	18.90	3.99	18.00	4.02	17.10	4.09
		5.0	4.0	21.80	4.44	20.40	4.28	18.90	4.19	18.00	4.23	17.10	4.29
		3.0	2.0	21.80	4.62	20.40	4.45	18.90	4.35	18.00	4.39	17.10	4.46
0.0		-1.0	21.80	4.93	20.40	4.76	18.90	4.65	18.00	4.69	17.10	4.77	
-3.0		-4.0	21.80	5.25	20.40	5.07	18.90	4.96	18.00	5.00	17.10	5.08	
-5.0		-6.0	21.80	5.60	20.30	5.41	18.90	5.30	18.00	5.35	17.10	5.43	
-7.0		-8.0	21.40	5.83	20.20	5.69	18.80	5.64	17.90	5.69	17.00	5.79	
-10.0		-11.0	20.90	6.02	20.10	5.96	18.80	6.00	17.80	6.06	17.00	6.15	
-12.0		-13.0	20.50	6.37	19.90	6.39	18.90	6.53	18.00	6.59	17.10	6.70	
-15.0		-16.0	20.30	6.87	19.80	6.99	19.10	7.24	18.10	7.31	17.20	7.43	
-17.0		-18.0	20.00	7.20	19.60	7.37	19.10	7.69	18.10	7.76	17.20	7.89	
-20.0		-21.0	19.80	7.39	19.40	7.57	18.90	7.90	18.10	7.97	17.40	8.10	
-22.0		-23.0	18.10	7.08	17.70	7.23	17.10	7.52	16.30	7.55	15.50	7.65	
-25.0		-26.0	15.70	6.56	15.10	6.67	14.40	6.90	13.60	6.86	12.90	6.91	

10. Capacity Table

Heating

TC : Total Capacity, PI : Power Input

Combination, % (Capacity index)	Outdoor Air Temp.		Indoor temperature									
			16 (°C, DB)		18 (°C, DB)		20 (°C, DB)		22 (°C, DB)		24 (°C, DB)	
	DB	WB	TC(kW)	PI(kW)	TC(kW)	PI(kW)	TC(kW)	PI(kW)	TC(kW)	PI(kW)	TC(kW)	PI(kW)
50	15.0	14.0	18.20	3.12	17.00	3.01	15.80	2.95	15.00	3.01	14.20	3.10
	13.0	12.0	18.20	3.17	17.00	3.06	15.80	3.00	15.00	3.06	14.20	3.14
	11.0	10.0	18.20	3.24	17.00	3.13	15.80	3.06	15.00	3.13	14.20	3.22
	9.0	8.0	18.20	3.28	17.00	3.17	15.80	3.10	15.00	3.17	14.20	3.26
	7.0	6.0	18.20	3.40	17.00	3.28	15.80	3.21	15.00	3.27	14.20	3.37
	5.0	4.0	18.20	3.54	17.00	3.42	15.80	3.35	15.00	3.41	14.20	3.51
	3.0	2.0	18.20	3.70	17.00	3.57	15.80	3.49	15.00	3.56	14.20	3.67
	0.0	-1.0	18.20	3.91	17.00	3.78	15.80	3.70	15.00	3.77	14.20	3.88
	-3.0	-4.0	18.20	4.16	17.00	4.02	15.80	3.93	15.00	4.01	14.20	4.13
	-5.0	-6.0	18.20	4.50	17.00	4.34	15.80	4.25	15.00	4.34	14.20	4.46
	-7.0	-8.0	18.10	4.89	16.90	4.72	15.70	4.63	14.90	4.72	14.20	4.85
	-10.0	-11.0	18.10	5.20	16.90	5.02	15.70	4.91	14.90	5.01	14.10	5.16
	-12.0	-13.0	18.20	5.60	17.00	5.41	15.80	5.29	15.00	5.40	14.20	5.56
	-15.0	-16.0	18.30	6.07	17.10	5.86	15.90	5.74	15.10	5.85	14.40	6.02
	-17.0	-18.0	18.50	6.63	17.30	6.40	16.10	6.26	15.30	6.39	14.50	6.57
	-20.0	-21.0	18.70	7.27	17.50	7.02	16.20	6.87	15.40	7.01	14.60	7.21
	-22.0	-23.0	16.80	6.82	15.50	6.56	14.30	6.39	13.50	6.48	12.80	6.64
	-25.0	-26.0	13.90	6.09	12.80	5.81	11.60	5.61	10.80	5.62	10.00	5.70

10. Capacity Table

AM120KXMDGH/EU

Cooling

TC : Total Capacity, PI : Power Input

Combination, % (Capacity index)	Outdoor Air Temp.	Indoor temperature													
		20 (°C, DB) 14 (°C, WB)		23 (°C, DB) 16 (°C, WB)		26 (°C, DB) 18 (°C, WB)		27 (°C, DB) 19 (°C, WB)		28 (°C, DB) 20 (°C, WB)		30 (°C, DB) 22 (°C, WB)		32 (°C, DB) 24 (°C, WB)	
		TC(kW)	PI(kW)	TC(kW)	PI(kW)	TC(kW)	PI(kW)	TC(kW)	PI(kW)	TC(kW)	PI(kW)	TC(kW)	PI(kW)	TC(kW)	PI(kW)
130	10.0	30.10	4.06	36.10	4.81	42.00	5.52	44.70	5.80	47.80	6.20	51.40	6.59	55.90	6.73
	12.0	29.80	4.15	35.70	4.93	41.60	5.67	44.30	5.95	47.40	6.35	50.90	6.78	55.30	6.94
	14.0	29.50	4.28	35.30	5.09	41.10	5.85	43.70	6.15	46.80	6.55	50.30	7.00	54.70	7.16
	16.0	29.30	4.40	35.00	5.23	40.80	6.07	43.50	6.38	46.50	6.78	50.00	7.23	54.30	7.41
	18.0	28.90	4.64	34.60	5.54	40.30	6.43	42.90	6.76	45.90	7.16	49.40	7.63	53.60	7.63
	20.0	28.50	4.87	34.10	5.83	39.70	6.78	42.30	7.10	45.20	7.52	48.60	8.02	52.80	7.90
	21.0	28.10	5.05	33.60	6.19	39.10	7.19	41.70	7.52	44.60	7.95	47.90	8.48	52.10	8.10
	23.0	27.60	5.38	33.00	6.59	38.40	7.61	40.90	7.97	43.80	8.41	47.00	8.97	51.10	8.56
	25.0	27.10	5.75	32.40	7.04	37.80	8.10	40.20	8.46	43.00	8.93	46.30	9.50	50.30	8.99
	27.0	26.60	6.09	31.80	7.45	37.00	8.54	39.40	8.91	42.20	9.37	45.30	9.98	49.30	9.56
	29.0	26.00	6.41	31.10	7.84	36.20	8.95	38.60	9.33	41.30	9.80	44.40	10.41	48.20	10.09
	31.0	25.50	6.76	30.50	8.07	35.50	9.29	37.80	9.76	40.40	10.25	43.40	10.86	47.20	10.68
	33.0	25.10	7.07	30.00	8.41	35.00	9.65	37.20	10.13	39.80	10.61	42.80	11.22	46.10	11.20
	35.0	24.60	7.43	29.40	8.77	34.30	10.06	36.50	10.54	39.10	11.00	42.00	11.60	44.30	11.59
	37.0	23.90	7.76	28.60	9.15	33.30	10.38	35.50	10.78	38.00	11.23	40.80	11.79	43.10	12.00
39.0	23.20	8.05	28.00	9.52	32.30	10.75	34.40	11.14	36.80	11.61	39.60	12.13	41.80	12.26	
120	10.0	29.00	3.74	34.70	4.44	40.40	5.12	43.00	5.44	45.60	5.73	48.60	6.01	50.70	6.22
	12.0	29.00	3.84	34.70	4.57	40.40	5.28	43.00	5.56	45.60	5.90	48.60	6.22	50.70	6.46
	14.0	28.70	4.08	34.30	4.85	39.90	5.62	42.50	5.91	45.10	6.25	48.10	6.62	50.10	6.67
	16.0	28.30	4.21	33.90	5.01	39.40	5.80	42.20	6.13	44.50	6.48	47.40	6.85	49.60	6.87
	18.0	28.20	4.34	33.70	5.17	39.20	6.01	41.70	6.35	44.20	6.71	47.10	7.09	49.20	7.10
	20.0	27.80	4.53	33.20	5.42	38.70	6.31	41.10	6.68	43.60	7.03	46.50	7.43	48.50	7.37
	21.0	27.40	4.68	32.70	5.74	38.10	6.68	40.50	7.05	43.00	7.40	45.80	7.83	47.80	7.55
	23.0	26.90	4.99	32.20	6.11	37.50	7.11	39.90	7.48	42.20	7.84	45.00	8.31	47.00	7.91
	25.0	26.60	5.33	31.80	6.52	37.00	7.59	39.30	7.95	41.70	8.31	44.40	8.79	46.40	8.41
	27.0	26.10	5.68	31.20	6.95	36.30	8.07	38.70	8.43	40.90	8.79	43.70	9.31	45.60	8.90
	29.0	25.60	5.97	30.60	7.29	35.60	8.44	37.90	8.80	40.20	9.18	42.80	9.69	44.70	9.42
	31.0	25.10	6.27	30.00	7.65	34.90	8.84	37.20	9.18	39.40	9.57	42.00	10.08	43.80	9.96
	33.0	24.60	6.60	29.40	8.05	34.20	9.25	36.40	9.62	38.60	10.00	41.10	10.51	43.00	10.35
	35.0	24.10	6.90	28.80	8.41	33.50	9.62	35.70	9.99	37.80	10.36	40.30	10.87	42.10	10.76
	37.0	23.50	7.20	28.20	8.54	32.70	9.95	34.80	10.33	36.90	10.69	39.40	11.18	40.90	11.12
39.0	23.10	7.60	27.60	8.94	32.00	10.24	34.00	10.61	35.80	11.06	38.20	11.52	39.90	11.41	
110	10.0	25.60	3.42	30.60	4.05	35.90	4.71	38.10	5.00	40.50	5.34	45.10	5.83	47.30	6.06
	12.0	25.60	3.51	30.60	4.17	35.90	4.85	38.10	5.12	40.50	5.48	45.10	6.02	47.30	6.29
	14.0	25.60	3.61	30.60	4.31	35.90	5.01	38.10	5.30	40.50	5.66	45.10	6.23	47.30	6.54
	16.0	25.60	3.73	30.60	4.44	35.90	5.18	38.10	5.47	40.50	5.86	45.10	6.47	47.30	6.78
	18.0	25.60	3.85	30.60	4.59	35.90	5.38	38.10	5.68	40.50	6.06	45.10	6.72	47.30	7.04
	20.0	25.60	3.99	30.60	4.78	35.90	5.61	38.10	5.93	40.50	6.33	44.80	6.97	47.30	7.37
	21.0	25.60	4.24	30.60	5.09	35.90	5.98	38.10	6.32	40.50	6.71	44.40	7.28	47.00	7.53
	23.0	25.60	4.47	30.60	5.48	35.90	6.45	38.10	6.78	40.50	7.20	43.60	7.68	46.20	7.85
	25.0	25.60	4.87	30.60	5.96	35.90	7.02	38.10	7.35	40.20	7.74	42.90	8.17	45.40	8.29
	27.0	25.60	5.22	30.60	6.37	35.90	7.51	38.10	7.85	39.70	8.12	42.00	8.54	44.80	8.84
	29.0	25.20	5.56	30.10	6.79	35.30	7.99	37.50	8.33	39.00	8.59	41.30	9.02	44.10	9.25
	31.0	24.70	5.84	29.60	7.12	34.70	8.39	36.90	8.72	38.30	8.93	40.60	9.37	43.20	9.77
	33.0	24.30	6.16	29.10	7.50	34.10	8.83	36.30	9.15	37.50	9.33	39.80	9.78	42.40	10.12
	35.0	23.80	6.49	28.60	7.90	33.50	9.25	35.60	9.61	36.80	9.74	39.00	10.19	41.50	10.56
	37.0	23.40	6.72	28.00	8.07	32.80	9.55	34.80	9.90	36.00	10.04	38.20	10.47	40.70	10.93
39.0	23.00	7.03	27.50	8.31	32.10	9.93	34.10	10.27	35.00	10.35	37.20	10.77	39.70	11.20	
100	10.0	22.70	3.16	27.20	3.75	31.60	4.31	33.50	4.57	35.60	4.86	39.60	5.36	43.70	5.73
	12.0	22.70	3.25	27.20	3.86	31.60	4.44	33.50	4.68	35.60	4.99	39.60	5.54	43.70	5.98
	14.0	22.70	3.36	27.20	4.01	31.60	4.61	33.50	4.86	35.60	5.18	39.60	5.77	43.70	6.26
	16.0	22.70	3.48	27.20	4.14	31.60	4.78	33.50	5.04	35.60	5.37	39.60	5.99	43.70	6.54
	18.0	22.70	3.59	27.20	4.28	31.60	4.94	33.50	5.22	35.60	5.57	39.60	6.21	43.70	6.82
	20.0	22.70	3.75	27.20	4.47	31.60	5.19	33.50	5.50	35.60	5.86	39.60	6.50	43.70	7.17
	21.0	22.70	3.91	27.20	4.75	31.60	5.54	33.50	5.85	35.60	6.23	39.60	6.90	43.20	7.36
	23.0	22.70	4.15	27.20	5.07	31.60	5.91	33.50	6.24	35.60	6.63	39.60	7.32	42.60	7.65
	25.0	22.70	4.45	27.20	5.43	31.60	6.34	33.50	6.69	35.60	7.09	39.60	7.80	41.90	8.00
	27.0	22.70	4.76	27.20	5.79	31.60	6.76	33.50	7.12	35.60	7.53	39.60	8.28	41.30	8.40
	29.0	22.70	5.08	27.20	6.18	31.60	7.21	33.50	7.59	35.60	7.99	39.60	8.77	40.70	8.78
	31.0	22.70	5.43	27.20	6.61	31.60	7.70	33.50	8.10	35.60	8.47	39.20	9.20	40.10	9.16
	33.0	22.70	5.79	27.20	7.03	31.60	8.20	33.50	8.49	35.60	8.93	38.40	9.51	39.30	9.56
	35.0	22.70	6.25	27.20	7.58	31.60	8.83	33.50	8.77	35.20	9.46	37.60	9.95	38.30	9.88
	37.0	22.70	6.62	27.20	7.95	31.30	9.25	32.80	9.26	34.50	9.76	36.20	10.09	36.90	10.20
39.0	22.70	7.10	27.20	8.43	31.20	9.69	32.20	9.73	33.50	10.00	34.80	10.21	35.50	10.32	
90	10.0	20.70	2.79	24.80	3.29	29.00	3.80	30.50	3.99	32.50	4.26	36.20	4.72	40.00	5.17
	12.0	20.70	2.84	24.80	3.35	29.00	3.88	30.50	4.08	32.50	4.35	36.20	4.82	40.00	5.29
	14.0	20.70	2.92	24.80	3.44	29.00	3.98	30.50	4.17	32.50	4.46	36.20	4.93	40.00	5.43
	16.0	20.70	3.00	24.80	3.54	29.00	4.11	30.50	4.29	32.50	4.58	36.20	5.08	40.00	5.60
	18.0	20.70	3.08	24.80	3.64	29.00	4.21	30.50	4.42	32.50	4.70	36.20	5.22	40.00	5.81
	20.0	20.70	3.20	24.80	3.78	29.00	4.38	30.50	4.58	32.50	4.89	36.20	5.49	40.00	6.08
	21.0	20.70	3.26	24.80	3.92	29.00	4.56	30.50	4.78	32.50	5.10	36.20	5.74	40.00	6.25
	23.0	20.70	3.41	24.80	4.07	29.00	4.83	30.50	5.07	32.50	5.39	36.20	6.07	40.00	6.58
	25.0	20.70	3.60	24.80	4.37	29.00	5.13	30.50	5.37	32.50	5.72	36.20	6.42	40.00	6.94
	27.0	20.70	3.85	24.80	4.66	29.00	5.47	30.50	5.73	32.50	6.08	36.20	6.82	40.00	7.39
	29.0	20.70	4.10	24.80	4.93	29.00	5.85	30.50	6.11	32.50	6.48	36.20	7.26	40.00	7.85
	31.0	20.70	4.38	24.80	5.26	29.00	6.23	30.50	6.50	32.50	6.88	36.20	7.66	40.00	8.31
	33.0	20.70	4.68	24.80	5.60	29.00	6.64	30.50	6.86	32.50	7.31	36.20	8.06	39.10	8.61
	35.0	20.70	5.02	24.80	5.95	29.00	7.11	30.50	7.21	32.50	7.80	36.20	8.59	38.10	8.90
	37.0	20.70	5.35	24.80	6.34	29.00	7.58	30.50	7.77	32.50	8.27	35.70	8.94	36.80	9.15
39.0	20.70	5.79	24.80	6.85											

10. Capacity Table

Cooling

TC : Total Capacity, PI : Power Input

Combination, % (Capacity Index)	Outdoor Air Temp.	Indoor temperature													
		20 (°C, DB) 14 (°C, WB)		23 (°C, DB) 16 (°C, WB)		26 (°C, DB) 18 (°C, WB)		27 (°C, DB) 19 (°C, WB)		28 (°C, DB) 20 (°C, WB)		30 (°C, DB) 22 (°C, WB)		32 (°C, DB) 24 (°C, WB)	
		TC(kW)	PI(kW)	TC(kW)	PI(kW)	TC(kW)	PI(kW)	TC(kW)	PI(kW)	TC(kW)	PI(kW)	TC(kW)	PI(kW)	TC(kW)	PI(kW)
80	10.0	18.70	2.43	22.30	2.84	25.90	3.26	27.10	3.40	29.00	3.64	32.40	4.06	35.80	4.42
	12.0	18.70	2.46	22.30	2.89	25.90	3.32	27.10	3.46	29.00	3.70	32.40	4.12	35.80	4.50
	14.0	18.70	2.50	22.30	2.94	25.90	3.37	27.10	3.51	29.00	3.76	32.40	4.18	35.80	4.58
	16.0	18.70	2.58	22.30	3.03	25.90	3.48	27.10	3.62	29.00	3.87	32.40	4.32	35.80	4.74
	18.0	18.70	2.65	22.30	3.11	25.90	3.57	27.10	3.71	29.00	3.97	32.40	4.43	35.80	4.88
	20.0	18.70	2.75	22.30	3.22	25.90	3.71	27.10	3.85	29.00	4.11	32.40	4.61	35.80	5.12
	21.0	18.70	2.79	22.30	3.29	25.90	3.78	27.10	3.91	29.00	4.19	32.40	4.72	35.80	5.25
	23.0	18.70	2.91	22.30	3.41	25.90	3.95	27.10	4.11	29.00	4.39	32.40	4.94	35.80	5.53
	25.0	18.70	3.03	22.30	3.59	25.90	4.16	27.10	4.32	29.00	4.61	32.40	5.18	35.80	5.80
	27.0	18.70	3.23	22.30	3.82	25.90	4.44	27.10	4.61	29.00	4.91	32.40	5.51	35.80	6.17
	29.0	18.70	3.46	22.30	4.09	25.90	4.74	27.10	4.91	29.00	5.23	32.40	5.87	35.80	6.58
	31.0	18.70	3.68	22.30	4.35	25.90	5.04	27.10	5.23	29.00	5.55	32.40	6.22	35.80	6.93
	33.0	18.70	3.92	22.30	4.63	25.90	5.37	27.10	5.56	29.00	5.90	32.40	6.57	35.80	7.30
	35.0	18.70	4.15	22.30	4.95	25.90	5.74	27.10	5.93	29.00	6.28	32.40	6.99	35.80	7.73
	37.0	18.70	4.39	22.30	5.27	25.90	6.10	27.10	6.30	29.00	6.67	32.40	7.39	35.80	8.17
	39.0	18.70	4.75	22.30	5.70	25.90	6.60	27.10	6.80	29.00	7.21	32.40	7.94	35.80	8.77
70	10.0	16.70	2.04	19.80	2.38	22.80	2.70	23.80	2.83	25.60	3.03	28.50	3.35	31.90	3.69
	12.0	16.70	2.09	19.80	2.44	22.80	2.78	23.80	2.88	25.60	3.11	28.50	3.45	31.90	3.81
	14.0	16.70	2.14	19.80	2.49	22.80	2.84	23.80	2.94	25.60	3.17	28.50	3.53	31.90	3.89
	16.0	16.70	2.22	19.80	2.58	22.80	2.95	23.80	3.02	25.60	3.28	28.50	3.65	31.90	4.05
	18.0	16.70	2.28	19.80	2.67	22.80	3.04	23.80	3.11	25.60	3.38	28.50	3.76	31.90	4.18
	20.0	16.70	2.36	19.80	2.76	22.80	3.14	23.80	3.21	25.60	3.48	28.50	3.88	31.90	4.34
	21.0	16.70	2.41	19.80	2.80	22.80	3.21	23.80	3.27	25.60	3.54	28.50	3.96	31.90	4.45
	23.0	16.70	2.50	19.80	2.91	22.80	3.32	23.80	3.42	25.60	3.70	28.50	4.16	31.90	4.66
	25.0	16.70	2.55	19.80	3.02	22.80	3.47	23.80	3.59	25.60	3.86	28.50	4.34	31.90	4.86
	27.0	16.70	2.69	19.80	3.19	22.80	3.67	23.80	3.79	25.60	4.07	28.50	4.57	31.90	5.13
	29.0	16.70	2.85	19.80	3.33	22.80	3.84	23.80	4.02	25.60	4.24	28.50	4.76	31.90	5.35
	31.0	16.70	3.02	19.80	3.54	22.80	4.07	23.80	4.27	25.60	4.48	28.50	5.03	31.90	5.64
	33.0	16.70	3.22	19.80	3.76	22.80	4.32	23.80	4.51	25.60	4.75	28.50	5.33	31.90	5.97
	35.0	16.70	3.40	19.80	4.02	22.80	4.62	23.80	4.82	25.60	5.07	28.50	5.68	31.90	6.34
	37.0	16.70	3.65	19.80	4.34	22.80	5.00	23.80	5.12	25.60	5.47	28.50	6.11	31.90	6.81
	39.0	16.70	3.93	19.80	4.68	22.80	5.37	23.80	5.53	25.60	5.86	28.50	6.55	31.90	7.27
60	10.0	14.50	1.72	17.20	2.00	19.80	2.27	20.40	2.34	22.20	2.54	24.70	2.81	27.80	3.09
	12.0	14.50	1.77	17.20	2.05	19.80	2.33	20.40	2.39	22.20	2.59	24.70	2.88	27.80	3.18
	14.0	14.50	1.81	17.20	2.10	19.80	2.39	20.40	2.44	22.20	2.65	24.70	2.95	27.80	3.26
	16.0	14.50	1.86	17.20	2.18	19.80	2.46	20.40	2.51	22.20	2.73	24.70	3.04	27.80	3.38
	18.0	14.50	1.93	17.20	2.24	19.80	2.54	20.40	2.58	22.20	2.81	24.70	3.13	27.80	3.49
	20.0	14.50	1.99	17.20	2.31	19.80	2.63	20.40	2.66	22.20	2.90	24.70	3.23	27.80	3.61
	21.0	14.50	2.03	17.20	2.36	19.80	2.67	20.40	2.71	22.20	2.95	24.70	3.29	27.80	3.67
	23.0	14.50	2.08	17.20	2.44	19.80	2.77	20.40	2.82	22.20	3.06	24.70	3.44	27.80	3.86
	25.0	14.50	2.13	17.20	2.50	19.80	2.89	20.40	2.95	22.20	3.19	24.70	3.60	27.80	4.05
	27.0	14.50	2.23	17.20	2.64	19.80	3.05	20.40	3.10	22.20	3.36	24.70	3.77	27.80	4.26
	29.0	14.50	2.35	17.20	2.80	19.80	3.20	20.40	3.29	22.20	3.52	24.70	3.95	27.80	4.46
	31.0	14.50	2.49	17.20	2.96	19.80	3.39	20.40	3.48	22.20	3.72	24.70	4.18	27.80	4.71
	33.0	14.50	2.64	17.20	3.13	19.80	3.59	20.40	3.67	22.20	3.93	24.70	4.41	27.80	4.97
	35.0	14.50	2.82	17.20	3.36	19.80	3.83	20.40	3.92	22.20	4.18	24.70	4.69	27.80	5.29
	37.0	14.50	3.02	17.20	3.52	19.80	4.11	20.40	4.17	22.20	4.48	24.70	5.01	27.80	5.65
	39.0	14.50	3.26	17.20	3.79	19.80	4.43	20.40	4.50	22.20	4.81	24.70	5.38	27.80	6.06
50	10.0	12.30	1.43	14.50	1.65	16.70	1.85	17.00	1.89	18.80	2.07	21.00	2.30	23.70	2.54
	12.0	12.30	1.46	14.50	1.68	16.70	1.90	17.00	1.92	18.80	2.12	21.00	2.36	23.70	2.60
	14.0	12.30	1.49	14.50	1.73	16.70	1.94	17.00	1.97	18.80	2.17	21.00	2.41	23.70	2.67
	16.0	12.30	1.54	14.50	1.77	16.70	1.99	17.00	2.03	18.80	2.22	21.00	2.47	23.70	2.74
	18.0	12.30	1.58	14.50	1.83	16.70	2.07	17.00	2.09	18.80	2.29	21.00	2.56	23.70	2.85
	20.0	12.30	1.64	14.50	1.88	16.70	2.13	17.00	2.14	18.80	2.36	21.00	2.64	23.70	2.94
	21.0	12.30	1.66	14.50	1.91	16.70	2.17	17.00	2.19	18.80	2.39	21.00	2.68	23.70	2.99
	23.0	12.30	1.70	14.50	1.96	16.70	2.24	17.00	2.28	18.80	2.49	21.00	2.79	23.70	3.12
	25.0	12.30	1.76	14.50	2.02	16.70	2.30	17.00	2.31	18.80	2.58	21.00	2.91	23.70	3.27
	27.0	12.30	1.82	14.50	2.11	16.70	2.41	17.00	2.48	18.80	2.71	21.00	3.05	23.70	3.43
	29.0	12.30	1.92	14.50	2.22	16.70	2.56	17.00	2.61	18.80	2.84	21.00	3.21	23.70	3.61
	31.0	12.30	2.04	14.50	2.36	16.70	2.72	17.00	2.76	18.80	3.01	21.00	3.39	23.70	3.82
	33.0	12.30	2.15	14.50	2.48	16.70	2.86	17.00	2.90	18.80	3.16	21.00	3.56	23.70	4.01
	35.0	12.30	2.30	14.50	2.65	16.70	3.02	17.00	3.10	18.80	3.37	21.00	3.78	23.70	4.27
	37.0	12.30	2.46	14.50	2.82	16.70	3.21	17.00	3.29	18.80	3.57	21.00	4.02	23.70	4.52
	39.0	12.30	2.64	14.50	3.04	16.70	3.47	17.00	3.51	18.80	3.84	21.00	4.31	23.70	4.86

10. Capacity Table

Heating

TC : Total Capacity, PI : Power Input

Combination, % (Capacity index)	Outdoor Air Temp.		Indoor temperature										
			16 (°C, DB)		18 (°C, DB)		20 (°C, DB)		22 (°C, DB)		24 (°C, DB)		
	DB	WB	TC(kW)	PI(kW)	TC(kW)	PI(kW)	TC(kW)	PI(kW)	TC(kW)	PI(kW)	TC(kW)	PI(kW)	
130	15.0	14.0	51.50	7.54	48.50	7.34	45.50	7.26	43.60	7.38	41.60	7.54	
	13.0	12.0	51.40	7.72	48.50	7.53	45.50	7.45	43.60	7.57	41.60	7.73	
	11.0	10.0	51.50	7.94	48.50	7.73	45.50	7.65	43.60	7.78	41.60	7.95	
	9.0	8.0	51.00	8.21	48.10	8.05	45.50	8.03	43.60	8.16	41.60	8.34	
	7.0	6.0	49.70	8.52	47.60	8.44	45.50	8.51	43.60	8.65	41.60	8.84	
	5.0	4.0	48.80	8.93	46.60	8.82	44.40	8.86	43.00	9.20	41.10	9.61	
	3.0	2.0	47.60	9.49	45.40	9.26	43.60	9.19	41.90	9.49	40.30	9.86	
	0.0	-1.0	46.70	10.52	44.70	10.19	42.50	10.01	41.00	10.36	39.50	10.79	
	-3.0	-4.0	45.40	11.47	43.50	11.14	41.60	10.98	40.20	11.28	38.80	11.65	
	-5.0	-6.0	44.20	11.84	42.10	11.55	40.80	11.45	39.10	11.77	37.80	12.16	
	-7.0	-8.0	43.10	11.97	41.50	11.74	39.60	11.70	38.30	12.01	36.90	12.38	
	-10.0	-11.0	41.30	11.73	40.00	11.66	38.80	11.80	37.40	12.08	36.00	12.44	
	-12.0	-13.0	40.10	11.60	39.10	11.57	37.60	11.75	36.70	12.16	35.30	12.66	
	-15.0	-16.0	39.40	11.52	38.70	11.54	37.40	11.77	36.40	12.17	35.40	12.66	
	-17.0	-18.0	37.70	11.27	37.50	11.42	36.70	11.78	35.80	12.34	35.00	13.01	
	-20.0	-21.0	36.00	11.18	36.20	11.40	35.60	11.84	34.60	12.20	33.50	12.65	
	-22.0	-23.0	34.40	11.17	34.60	11.38	33.90	11.81	32.90	12.18	31.90	12.67	
	-25.0	-26.0	31.40	10.89	31.40	11.08	30.70	11.48	29.80	11.85	28.80	12.38	
	120	15.0	14.0	48.80	7.39	45.80	7.17	42.80	7.06	40.90	7.17	39.00	7.31
		13.0	12.0	48.90	7.61	45.80	7.39	42.80	7.27	40.90	7.38	39.00	7.53
11.0		10.0	48.70	7.86	45.80	7.63	42.80	7.52	40.90	7.64	39.00	7.79	
9.0		8.0	48.70	8.25	45.80	8.01	42.80	7.90	40.90	8.02	39.00	8.18	
7.0		6.0	48.80	8.73	45.80	8.47	42.80	8.35	40.90	8.48	39.00	8.65	
5.0		4.0	48.80	9.29	45.80	9.02	42.80	8.89	40.90	9.03	39.00	9.20	
3.0		2.0	47.60	9.90	45.30	9.68	42.70	9.62	40.80	9.78	39.00	9.99	
0.0		-1.0	47.20	10.79	44.70	10.46	42.60	10.28	41.20	10.67	39.20	11.15	
-3.0		-4.0	46.40	11.53	43.90	11.05	42.10	10.72	40.90	11.17	39.00	11.70	
-5.0		-6.0	45.50	12.20	42.90	11.53	41.40	11.01	39.90	11.39	38.40	11.85	
-7.0		-8.0	44.00	12.56	42.30	11.77	40.30	11.12	39.10	11.47	37.60	11.91	
-10.0		-11.0	42.50	12.91	40.80	12.07	38.80	11.36	37.80	11.77	36.50	12.27	
-12.0		-13.0	40.60	12.80	39.00	12.12	37.10	11.62	35.90	11.95	34.70	12.35	
-15.0		-16.0	39.80	12.74	38.50	12.22	36.70	11.82	35.60	12.30	34.50	12.87	
-17.0		-18.0	38.10	12.49	36.90	12.13	35.70	11.94	34.50	12.40	33.40	12.97	
-20.0		-21.0	36.50	12.15	36.00	12.05	34.80	12.16	33.40	12.62	32.20	13.18	
-22.0		-23.0	35.00	12.15	34.50	12.04	33.30	12.14	31.80	12.61	30.80	13.21	
-25.0		-26.0	32.00	11.87	31.50	11.75	30.10	11.83	28.90	12.29	27.90	12.94	
110		15.0	14.0	46.90	7.24	43.90	7.02	41.00	6.90	39.10	6.99	37.20	7.11
		13.0	12.0	46.90	7.48	43.90	7.25	41.00	7.12	39.10	7.22	37.20	7.34
	11.0	10.0	46.90	7.78	43.90	7.54	41.00	7.41	39.10	7.51	37.20	7.64	
	9.0	8.0	46.90	8.17	43.90	7.91	41.00	7.78	39.10	7.88	37.20	8.02	
	7.0	6.0	46.90	8.62	43.90	8.35	41.00	8.21	39.10	8.32	37.20	8.46	
	5.0	4.0	46.80	9.02	43.80	8.74	40.80	8.59	39.00	8.72	37.20	8.88	
	3.0	2.0	46.20	9.58	43.50	9.33	40.90	9.23	39.00	9.37	37.20	9.54	
	0.0	-1.0	45.30	9.96	42.80	9.94	40.90	10.10	39.00	10.24	37.20	10.43	
	-3.0	-4.0	44.20	10.52	42.60	10.49	40.60	10.64	38.70	10.99	37.20	11.41	
	-5.0	-6.0	43.50	11.13	41.80	11.07	40.10	11.19	38.30	11.59	37.00	12.08	
	-7.0	-8.0	41.80	11.52	40.70	11.56	39.00	11.82	37.70	12.14	36.40	12.53	
	-10.0	-11.0	40.30	12.09	38.90	11.97	37.30	12.09	36.20	12.48	34.80	12.95	
	-12.0	-13.0	38.50	12.15	37.30	11.97	35.60	12.02	34.60	12.40	33.30	12.87	
	-15.0	-16.0	37.70	12.30	36.40	12.26	34.80	12.37	33.80	12.78	32.50	13.28	
	-17.0	-18.0	36.00	12.15	35.10	12.10	33.70	12.22	32.90	12.69	31.50	13.25	
	-20.0	-21.0	35.00	12.20	34.20	12.10	32.80	12.21	31.90	12.64	30.40	13.16	
	-22.0	-23.0	33.40	12.15	32.60	12.05	31.10	12.15	30.30	12.59	28.90	13.14	
	-25.0	-26.0	30.30	11.80	29.50	11.67	27.90	11.75	27.20	12.18	26.00	12.78	
	100	15.0	14.0	43.40	6.92	40.40	6.67	37.50	6.52	35.60	6.58	33.80	6.68
		13.0	12.0	43.40	7.17	40.40	6.91	37.50	6.76	35.60	6.82	33.80	6.92
11.0		10.0	43.40	7.51	40.40	7.24	37.50	7.08	35.60	7.14	33.80	7.26	
9.0		8.0	43.40	7.89	40.40	7.61	37.50	7.44	35.60	7.50	33.80	7.62	
7.0		6.0	43.40	8.31	40.40	8.01	37.50	7.83	35.60	7.90	33.80	8.02	
5.0		4.0	43.40	8.54	40.40	8.23	37.50	8.04	35.60	8.11	33.80	8.24	
3.0		2.0	43.40	9.03	40.40	8.70	37.50	8.50	35.60	8.58	33.80	8.71	
0.0		-1.0	43.10	9.50	40.30	9.19	37.50	9.02	35.60	9.10	33.80	9.25	
-3.0		-4.0	42.00	9.87	39.80	9.66	37.50	9.61	35.60	9.70	33.80	9.85	
-5.0		-6.0	40.90	10.43	39.00	10.29	37.10	10.33	35.60	10.42	33.70	10.55	
-7.0		-8.0	39.50	10.74	37.90	10.63	36.20	10.70	34.80	11.14	33.00	11.30	
-10.0		-11.0	37.80	11.58	36.50	11.61	35.30	11.84	33.50	11.94	31.80	12.09	
-12.0		-13.0	36.20	11.79	35.20	11.87	33.90	12.16	32.20	12.27	30.40	12.42	
-15.0		-16.0	35.10	12.32	34.60	12.42	33.10	12.74	31.40	12.86	29.70	13.02	
-17.0		-18.0	33.50	12.37	32.90	12.36	31.70	12.58	30.00	12.69	28.50	12.85	
-20.0		-21.0	32.50	12.56	31.80	12.45	30.40	12.56	28.70	12.37	27.30	12.83	
-22.0		-23.0	30.90	12.56	30.10	12.45	28.70	12.56	27.20	12.38	25.80	12.88	
-25.0		-26.0	27.70	12.25	26.90	12.12	25.50	12.20	24.10	12.04	22.90	12.60	

10. Capacity Table

Heating

TC : Total Capacity, PI : Power Input

Combination, % (Capacity index)	Outdoor Air Temp.		Indoor temperature									
			16 (°C, DB)		18 (°C, DB)		20 (°C, DB)		22 (°C, DB)		24 (°C, DB)	
	DB	WB	TC(kW)	PI(kW)	TC(kW)	PI(kW)	TC(kW)	PI(kW)	TC(kW)	PI(kW)	TC(kW)	PI(kW)
90	15.0	14.0	39.00	6.34	36.40	6.11	33.70	5.97	32.00	6.02	30.40	6.12
	13.0	12.0	39.00	6.56	36.40	6.32	33.70	6.18	32.00	6.23	30.40	6.33
	11.0	10.0	39.00	6.81	36.40	6.57	33.70	6.42	32.00	6.47	30.40	6.58
	9.0	8.0	39.00	7.15	36.40	6.90	33.70	6.74	32.00	6.80	30.40	6.90
	7.0	6.0	39.00	7.52	36.40	7.25	33.70	7.09	32.00	7.15	30.40	7.26
	5.0	4.0	39.00	7.83	36.40	7.54	33.70	7.37	32.00	7.44	30.40	7.55
	3.0	2.0	39.00	8.20	36.40	7.91	33.70	7.73	32.00	7.79	30.40	7.92
	0.0	-1.0	39.00	8.76	36.40	8.44	33.70	8.25	32.00	8.32	30.40	8.45
	-3.0	-4.0	39.00	9.34	36.40	9.00	33.70	8.80	32.00	8.88	30.40	9.02
	-5.0	-6.0	38.50	9.57	36.20	9.48	33.70	9.55	32.00	9.64	30.40	9.79
	-7.0	-8.0	37.80	9.73	35.40	9.90	33.70	10.28	32.00	10.37	30.40	10.53
	-10.0	-11.0	36.00	9.88	34.20	10.40	32.80	11.10	31.60	10.45	29.80	10.61
	-12.0	-13.0	33.40	10.05	31.90	10.62	31.00	11.37	29.40	10.63	27.90	10.79
	-15.0	-16.0	32.00	10.54	31.30	11.05	30.10	11.74	28.20	10.64	26.80	10.81
	-17.0	-18.0	30.70	10.84	30.20	11.35	29.00	12.08	27.60	10.81	26.00	10.98
	-20.0	-21.0	29.40	11.18	29.20	11.64	28.10	12.34	26.30	11.16	24.80	11.07
	-22.0	-23.0	27.80	11.13	27.60	11.57	26.50	12.27	24.80	11.10	23.40	11.04
-25.0	-26.0	24.90	10.75	24.60	11.16	23.40	11.80	21.90	10.69	20.70	10.69	
80	15.0	14.0	34.60	5.76	32.30	5.55	29.90	5.42	28.40	5.47	27.00	5.56
	13.0	12.0	34.60	5.94	32.30	5.73	29.90	5.60	28.40	5.65	27.00	5.74
	11.0	10.0	34.60	6.11	32.30	5.89	29.90	5.75	28.40	5.80	27.00	5.89
	9.0	8.0	34.60	6.41	32.30	6.18	29.90	6.04	28.40	6.09	27.00	6.19
	7.0	6.0	34.60	6.73	32.30	6.49	29.90	6.34	28.40	6.40	27.00	6.50
	5.0	4.0	34.60	7.12	32.30	6.86	29.90	6.71	28.40	6.77	27.00	6.87
	3.0	2.0	34.60	7.37	32.30	7.11	29.90	6.95	28.40	7.01	27.00	7.12
	0.0	-1.0	34.60	7.94	32.30	7.65	29.90	7.48	28.40	7.55	27.00	7.66
	-3.0	-4.0	34.60	8.26	32.30	8.04	29.90	7.99	28.40	8.06	27.00	8.19
	-5.0	-6.0	33.70	8.39	31.90	8.34	29.90	8.46	28.40	8.53	27.00	8.66
	-7.0	-8.0	32.60	8.44	31.30	8.57	29.90	8.84	28.40	8.92	27.00	9.06
	-10.0	-11.0	31.10	8.67	30.40	8.82	28.90	9.09	27.50	9.17	26.10	9.31
	-12.0	-13.0	29.40	8.70	28.30	8.91	27.20	9.29	25.80	9.37	24.50	9.52
	-15.0	-16.0	28.30	9.21	27.60	9.34	26.50	9.65	25.40	9.52	24.10	9.67
	-17.0	-18.0	27.10	9.41	26.50	9.57	25.60	9.92	24.60	9.83	23.10	9.98
	-20.0	-21.0	26.00	9.60	25.70	9.80	24.80	10.19	23.40	9.73	22.50	9.88
	-22.0	-23.0	24.70	9.54	24.30	9.74	23.40	10.12	22.10	9.67	21.20	9.85
-25.0	-26.0	22.10	9.22	21.70	9.38	20.80	9.73	19.60	9.30	18.80	9.51	
70	15.0	14.0	30.30	5.04	28.20	4.86	26.20	4.75	24.80	4.79	23.60	4.86
	13.0	12.0	30.30	5.19	28.20	5.00	26.20	4.89	24.80	4.93	23.60	5.00
	11.0	10.0	30.30	5.33	28.20	5.13	26.20	5.02	24.80	5.06	23.60	5.14
	9.0	8.0	30.30	5.55	28.20	5.35	26.20	5.23	24.80	5.27	23.60	5.35
	7.0	6.0	30.30	5.81	28.20	5.60	26.20	5.47	24.80	5.52	23.60	5.60
	5.0	4.0	30.30	6.12	28.20	5.90	26.20	5.77	24.80	5.82	23.60	5.91
	3.0	2.0	30.30	6.35	28.20	6.12	26.20	5.98	24.80	6.04	23.60	6.13
	0.0	-1.0	30.30	6.82	28.20	6.57	26.20	6.42	24.80	6.48	23.60	6.58
	-3.0	-4.0	30.30	7.28	28.20	7.01	26.20	6.85	24.80	6.91	23.60	7.02
	-5.0	-6.0	29.90	7.56	28.00	7.36	26.20	7.28	24.80	7.35	23.60	7.46
	-7.0	-8.0	29.40	7.71	27.90	7.63	26.20	7.68	24.80	7.74	23.60	7.86
	-10.0	-11.0	28.90	7.84	27.40	7.93	26.20	8.09	24.80	8.16	23.60	8.29
	-12.0	-13.0	27.60	8.06	26.70	8.15	25.60	8.32	24.30	8.75	23.40	8.68
	-15.0	-16.0	26.80	8.39	26.10	8.59	25.30	8.96	24.00	9.03	22.80	9.17
	-17.0	-18.0	26.20	8.75	25.60	8.95	24.80	9.34	23.60	9.42	22.40	9.57
	-20.0	-21.0	24.90	8.88	24.90	9.09	24.10	9.48	22.90	9.56	21.80	9.71
	-22.0	-23.0	23.60	8.44	23.60	9.00	22.80	9.38	21.60	9.43	20.40	9.57
-25.0	-26.0	21.20	8.44	21.00	8.61	20.20	8.95	19.00	8.93	17.80	9.03	
60	15.0	14.0	25.90	4.32	24.10	4.17	22.40	4.07	21.20	4.11	20.20	4.17
	13.0	12.0	25.90	4.43	24.10	4.27	22.40	4.17	21.20	4.21	20.20	4.27
	11.0	10.0	25.90	4.54	24.10	4.38	22.40	4.28	21.20	4.31	20.20	4.38
	9.0	8.0	25.90	4.69	24.10	4.52	22.40	4.42	21.20	4.46	20.20	4.52
	7.0	6.0	25.90	4.89	24.10	4.71	22.40	4.61	21.20	4.65	20.20	4.72
	5.0	4.0	25.90	5.14	24.10	4.95	22.40	4.84	21.20	4.88	20.20	4.95
	3.0	2.0	25.90	5.34	24.10	5.15	22.40	5.03	21.20	5.07	20.20	5.15
	0.0	-1.0	25.90	5.71	24.10	5.50	22.40	5.37	21.20	5.42	20.20	5.50
	-3.0	-4.0	25.90	6.08	24.10	5.86	22.40	5.73	21.20	5.78	20.20	5.87
	-5.0	-6.0	25.80	6.48	24.10	6.26	22.40	6.12	21.20	6.17	20.20	6.27
	-7.0	-8.0	25.20	6.75	24.10	6.58	22.40	6.52	21.20	6.58	20.20	6.68
	-10.0	-11.0	24.80	6.96	23.70	6.89	22.40	6.93	21.20	6.99	20.20	7.10
	-12.0	-13.0	24.30	7.30	23.30	7.32	22.40	7.47	21.20	7.54	20.20	7.65
	-15.0	-16.0	24.10	7.95	23.50	8.09	22.90	8.38	21.70	8.45	20.60	8.58
	-17.0	-18.0	23.80	8.34	23.40	8.53	22.90	8.90	21.80	8.98	20.70	9.12
	-20.0	-21.0	23.50	8.57	23.30	8.77	22.80	9.15	21.60	9.23	20.50	9.37
	-22.0	-23.0	22.10	8.41	21.90	8.60	21.30	8.95	20.20	9.00	19.10	9.12
-25.0	-26.0	19.60	7.92	19.20	8.07	18.60	8.37	17.40	8.34	16.30	8.42	

10. Capacity Table

Heating

TC : Total Capacity, PI : Power Input

Combination, % (Capacity index)	Outdoor Air Temp.		Indoor temperature									
			16 (°C, DB)		18 (°C, DB)		20 (°C, DB)		22 (°C, DB)		24 (°C, DB)	
	DB	WB	TC(kW)	PI(kW)	TC(kW)	PI(kW)	TC(kW)	PI(kW)	TC(kW)	PI(kW)	TC(kW)	PI(kW)
50	15.0	14.0	21.50	3.60	20.00	3.48	18.60	3.40	17.70	3.47	16.80	3.56
	13.0	12.0	21.50	3.66	20.00	3.53	18.60	3.45	17.70	3.52	16.80	3.62
	11.0	10.0	21.50	3.74	20.00	3.61	18.60	3.53	17.70	3.60	16.80	3.70
	9.0	8.0	21.50	3.79	20.00	3.66	18.60	3.58	17.70	3.65	16.80	3.75
	7.0	6.0	21.50	3.92	20.00	3.78	18.60	3.70	17.70	3.77	16.80	3.87
	5.0	4.0	21.50	4.09	20.00	3.94	18.60	3.86	17.70	3.93	16.80	4.04
	3.0	2.0	21.50	4.27	20.00	4.12	18.60	4.03	17.70	4.10	16.80	4.22
	0.0	-1.0	21.50	4.52	20.00	4.36	18.60	4.26	17.70	4.35	16.80	4.47
	-3.0	-4.0	21.50	4.80	20.00	4.63	18.60	4.53	17.70	4.62	16.80	4.75
	-5.0	-6.0	21.50	5.19	20.00	5.01	18.60	4.90	17.70	4.99	16.80	5.13
	-7.0	-8.0	21.40	5.65	20.00	5.45	18.60	5.33	17.70	5.43	16.80	5.58
	-10.0	-11.0	21.40	6.00	20.00	5.79	18.60	5.66	17.70	5.77	16.80	5.93
	-12.0	-13.0	21.30	6.40	20.00	6.18	18.60	6.04	17.70	6.16	16.80	6.33
	-15.0	-16.0	21.70	7.02	20.50	6.77	19.00	6.62	18.10	6.75	17.10	6.94
	-17.0	-18.0	22.00	7.67	20.80	7.40	19.30	7.23	18.30	7.37	17.40	7.58
	-20.0	-21.0	22.20	8.42	21.10	8.12	19.60	7.94	18.60	8.10	17.60	8.32
	-22.0	-23.0	20.60	8.15	19.50	7.84	18.00	7.65	17.00	7.76	16.10	7.96
	-25.0	-26.0	17.60	7.44	16.60	7.11	15.10	6.89	14.10	6.92	13.20	7.04

10. Capacity Table

AM140KXMDGH/EU

Cooling

TC : Total Capacity, PI : Power Input

Combination, % (Capacity Index)	Outdoor Air Temp.	Indoor temperature													
		20 (°C, DB) 14 (°C, WB)		23 (°C, DB) 16 (°C, WB)		26 (°C, DB) 18 (°C, WB)		27 (°C, DB) 19 (°C, WB)		28 (°C, DB) 20 (°C, WB)		30 (°C, DB) 22 (°C, WB)		32 (°C, DB) 24 (°C, WB)	
		TC(kW)	PI(kW)	TC(kW)	PI(kW)	TC(kW)	PI(kW)	TC(kW)	PI(kW)	TC(kW)	PI(kW)	TC(kW)	PI(kW)	TC(kW)	PI(kW)
130	10.0	36.00	5.11	42.90	5.95	50.10	6.82	53.40	7.16	57.10	7.65	61.40	8.16	66.70	8.19
	12.0	35.60	5.24	42.50	6.10	49.60	6.98	52.90	7.33	56.60	7.80	60.80	8.35	66.10	8.42
	14.0	35.20	5.41	42.00	6.30	49.10	7.21	52.20	7.55	55.90	8.03	60.10	8.61	65.30	8.66
	16.0	35.00	5.58	41.70	6.49	48.70	7.43	51.90	7.77	55.50	8.26	59.70	8.85	64.80	8.92
	18.0	34.50	5.94	41.20	6.90	48.10	7.89	51.30	8.26	54.80	8.74	58.90	9.38	64.10	9.14
	20.0	34.00	6.29	40.60	7.29	47.40	8.34	50.50	8.70	54.00	9.20	58.00	9.88	63.10	9.44
	21.0	33.50	6.80	40.00	7.87	46.70	8.99	49.70	9.37	53.20	9.88	57.20	10.61	62.20	9.72
	23.0	32.90	7.29	39.30	8.42	45.90	9.61	48.80	10.01	52.30	10.53	56.20	11.29	61.10	10.32
	25.0	32.40	7.85	38.60	9.05	45.10	10.33	48.00	10.74	51.40	11.27	55.20	12.07	60.00	10.87
	27.0	31.70	8.37	37.80	9.63	44.20	10.98	47.10	11.39	50.40	11.93	54.10	12.76	58.80	11.70
	29.0	31.10	8.86	37.00	10.16	43.30	11.57	46.10	11.98	49.30	12.53	53.00	13.37	57.60	12.46
	31.0	30.40	9.38	36.30	10.74	42.30	12.21	45.10	12.62	48.30	13.17	51.90	14.02	56.40	13.32
	33.0	30.00	9.80	35.70	11.18	41.80	12.69	44.50	13.10	47.60	13.64	51.10	14.47	55.00	14.08
	35.0	29.40	10.33	35.10	11.72	40.90	13.28	43.60	13.67	46.60	14.19	50.10	14.98	52.90	14.75
	37.0	28.60	11.01	34.10	12.45	39.80	14.08	42.40	14.47	45.40	14.99	48.80	15.75	51.50	15.45
	39.0	27.70	11.65	33.40	13.13	38.60	14.81	41.10	15.20	44.00	15.90	47.30	16.44	49.90	15.95
120	10.0	34.70	4.67	41.30	5.45	48.30	6.23	51.30	6.57	54.40	6.99	58.00	7.35	60.60	7.63
	12.0	34.70	4.79	41.30	5.60	48.30	6.39	51.30	6.73	54.40	7.15	58.00	7.53	60.60	7.86
	14.0	34.20	5.18	40.80	6.02	47.70	6.89	50.80	7.23	53.80	7.63	57.40	8.09	59.80	8.09
	16.0	33.80	5.36	40.30	6.24	47.10	7.15	50.40	7.48	53.10	7.87	56.60	8.36	59.20	8.31
	18.0	33.60	5.52	40.10	6.42	46.80	7.34	49.80	7.68	52.80	8.07	56.30	8.59	58.80	8.51
	20.0	33.20	5.82	39.50	6.75	46.20	7.72	49.10	8.06	52.10	8.46	55.50	9.00	58.00	8.82
	21.0	32.70	6.25	39.00	7.24	45.50	8.29	48.40	8.64	51.30	9.04	54.70	9.62	57.10	9.06
	23.0	32.10	6.71	38.30	7.75	44.70	8.87	47.60	9.24	50.40	9.64	53.80	10.26	56.20	9.52
	25.0	31.70	7.20	37.80	8.32	44.20	9.50	47.00	9.88	49.70	10.28	53.10	10.95	55.40	10.19
	27.0	31.20	7.74	37.20	8.92	43.40	10.18	46.20	10.56	48.80	10.97	52.20	11.68	54.50	10.87
	29.0	30.60	8.14	36.40	9.36	42.60	10.68	45.30	11.06	48.00	11.48	51.20	12.18	53.40	11.60
	31.0	30.00	8.59	35.70	9.85	41.70	11.21	44.40	11.60	47.00	12.01	50.10	12.71	52.40	12.37
	33.0	29.40	9.09	35.00	10.40	40.90	11.82	43.50	12.21	46.10	12.62	49.10	13.32	51.30	12.91
	35.0	28.80	9.53	34.30	10.86	40.00	12.33	42.60	12.72	45.10	13.12	48.10	13.81	50.30	13.48
	37.0	28.00	10.06	33.60	11.42	39.00	12.93	41.60	13.30	44.00	13.68	47.00	14.32	48.80	14.12
	39.0	27.60	10.80	32.80	12.23	38.20	13.82	40.60	14.18	42.80	14.55	45.60	15.17	47.60	14.61
110	10.0	30.50	4.37	36.40	5.10	42.80	5.86	45.50	6.19	48.40	6.59	53.90	7.24	56.50	7.55
	12.0	30.50	4.47	36.40	5.23	42.80	6.00	45.50	6.33	48.40	6.74	53.90	7.42	56.50	7.76
	14.0	30.50	4.61	36.40	5.38	42.80	6.19	45.50	6.52	48.40	6.91	53.90	7.64	56.50	8.02
	16.0	30.50	4.74	36.40	5.54	42.80	6.37	45.50	6.69	48.40	7.10	53.90	7.85	56.50	8.27
	18.0	30.50	4.89	36.40	5.69	42.80	6.55	45.50	6.87	48.40	7.27	53.90	8.06	56.50	8.51
	20.0	30.50	5.08	36.40	5.92	42.80	6.82	45.50	7.14	48.40	7.52	53.50	8.31	56.50	8.84
	21.0	30.50	5.49	36.40	6.38	42.80	7.35	45.50	7.67	48.40	8.06	53.00	8.74	56.10	9.03
	23.0	30.50	5.94	36.40	6.89	42.80	7.94	45.50	8.28	48.40	8.68	52.10	9.27	55.10	9.42
	25.0	30.50	6.53	36.40	7.56	42.80	8.69	45.50	9.05	48.00	9.41	51.20	9.95	54.20	10.01
	27.0	30.50	6.99	36.40	8.08	42.80	9.28	45.50	9.65	47.40	9.88	50.20	10.44	53.50	10.76
	29.0	30.00	7.50	35.90	8.67	42.10	9.95	44.80	10.32	46.60	10.53	49.30	11.10	52.60	11.30
	31.0	29.60	7.89	35.30	9.09	41.50	10.43	44.10	10.80	45.70	10.97	48.40	11.56	51.60	12.03
	33.0	29.00	8.36	34.60	9.60	40.70	11.01	43.30	11.39	44.80	11.52	47.50	12.11	50.60	12.50
	35.0	28.50	8.85	34.00	10.14	40.00	11.60	42.50	11.98	43.90	12.07	46.50	12.66	49.60	13.10
	37.0	27.90	9.27	33.30	10.58	39.10	12.08	41.60	12.46	43.00	12.54	45.60	13.12	48.60	13.69
	39.0	27.40	9.82	32.70	11.15	38.30	12.71	40.70	13.07	41.80	13.10	44.40	13.63	47.40	14.16
100	10.0	27.10	4.06	32.30	4.73	37.70	5.39	40.00	5.68	42.50	6.03	47.30	6.65	52.10	7.29
	12.0	27.10	4.16	32.30	4.85	37.70	5.54	40.00	5.82	42.50	6.18	47.30	6.83	52.10	7.50
	14.0	27.10	4.33	32.30	5.03	37.70	5.75	40.00	6.03	42.50	6.41	47.30	7.08	52.10	7.81
	16.0	27.10	4.47	32.30	5.20	37.70	5.93	40.00	6.23	42.50	6.59	47.30	7.30	52.10	8.08
	18.0	27.10	4.62	32.30	5.36	37.70	6.13	40.00	6.42	42.50	6.79	47.30	7.52	52.10	8.35
	20.0	27.10	4.84	32.30	5.63	37.70	6.43	40.00	6.71	42.50	7.09	47.30	7.86	52.10	8.74
	21.0	27.10	5.25	32.30	6.08	37.70	6.95	40.00	7.24	42.50	7.62	47.30	8.46	51.60	8.99
	23.0	27.10	5.60	32.30	6.48	37.70	7.39	40.00	7.69	42.50	8.07	47.30	8.97	50.80	9.34
	25.0	27.10	6.02	32.30	6.95	37.70	7.94	40.00	8.25	42.50	8.64	47.30	9.59	50.00	9.76
	27.0	27.10	6.43	32.30	7.42	37.70	8.46	40.00	8.77	42.50	9.17	47.30	10.19	49.30	10.28
	29.0	27.10	6.87	32.30	7.91	37.70	9.01	40.00	9.33	42.50	9.74	47.30	10.80	48.60	10.77
	31.0	27.10	7.37	32.30	8.46	37.70	9.63	40.00	9.96	42.50	10.36	46.80	11.35	47.90	11.26
	33.0	27.10	7.87	32.30	9.02	37.70	10.25	40.00	10.37	42.50	10.99	45.80	11.75	46.90	11.78
	35.0	27.10	8.56	32.30	9.78	37.70	11.10	40.00	10.99	42.00	11.71	44.90	12.38	45.70	12.21
	37.0	27.10	9.17	32.30	10.44	37.40	11.75	39.20	11.42	41.20	12.19	43.30	12.64	44.10	12.81
	39.0	27.10	9.99	32.30	11.33	37.20	12.44	38.40	12.28	40.00	12.61	41.60	12.91	42.40	13.07
90	10.0	24.80	3.62	29.50	4.22	34.60	4.84	36.40	5.05	38.80	5.37	43.30	5.93	47.70	6.49
	12.0	24.80	3.70	29.50	4.31	34.60	4.95	36.40	5.16	38.80	5.48	43.30	6.07	47.70	6.65
	14.0	24.80	3.80	29.50	4.42	34.60	5.08	36.40	5.29	38.80	5.63	43.30	6.23	47.70	6.84
	16.0	24.80	3.93	29.50	4.58	34.60	5.26	36.40	5.47	38.80	5.81	43.30	6.44	47.70	7.10
	18.0	24.80	4.07	29.50	4.72	34.60	5.43	36.40	5.63	38.80	5.97	43.30	6.63	47.70	7.33
	20.0	24.80	4.25	29.50	4.94	34.60	5.67	36.40	5.89	38.80	6.23	43.30	6.92	47.70	7.67
	21.0	24.80	4.48	29.50	5.20	34.60	5.97	36.40	6.18	38.80	6.53	43.30	7.26	47.70	7.90
	23.0	24.80	4.73	29.50	5.49	34.60	6.30	36.40	6.51	38.80	6.85	43.30	7.64	47.70	8.30
	25.0	24.80	5.02	29.50	5.82	34.60	6.68	36.40	6.88	38.80	7.23	43.30	8.06	47.70	8.73
	27.0	24.80	5.37	29.50	6.21	34.60	7.13	36.40	7.33	38.80	7.69	43.30	8.56	47.70	9.31
	29.0	24.80	5.75	29.50	6.63	34.60	7.61	36.40	7.81	38.80	8.18	43.30	9.09	47.70	9.90
	31.0	24.80	6.16	29.50	7.08	34.60	8.10	36.40	8.32	38.80	8.68	43.30	9.64	47.70	10.49
	33.0	24.80	6.57	29.50	7.54	34.60	8.63	36.40	8.75	38.80	9.21	43.30	10.21	46.60	10.92
	35.0	24.80	7.11	29.50	8.12	34.60	9.28	36.40	9.13	38.80	9.88	43.30	10.92	45.50	11.32
	37.0	24.80	7.60	29.50	8.67	34.60	9.89	36.40	9.89	38					

10. Capacity Table

Cooling

TC : Total Capacity, PI : Power Input

Combination, % (Capacity index)	Outdoor Air Temp.	Indoor temperature														
		20 (°C, DB) 14 (°C, WB)		23 (°C, DB) 16 (°C, WB)		26 (°C, DB) 18 (°C, WB)		27 (°C, DB) 19 (°C, WB)		28 (°C, DB) 20 (°C, WB)		30 (°C, DB) 22 (°C, WB)		32 (°C, DB) 24 (°C, WB)		
		TC(kW)	PI(kW)	TC(kW)	PI(kW)	TC(kW)	PI(kW)	TC(kW)	PI(kW)	TC(kW)	PI(kW)	TC(kW)	PI(kW)	TC(kW)	PI(kW)	
80	10.0	22.40	3.18	26.60	3.70	31.00	4.21	32.40	4.38	34.70	4.67	38.70	5.16	42.80	5.63	
	12.0	22.40	3.23	26.60	3.76	31.00	4.28	32.40	4.44	34.70	4.74	38.70	5.25	42.80	5.74	
	14.0	22.40	3.28	26.60	3.81	31.00	4.35	32.40	4.50	34.70	4.81	38.70	5.32	42.80	5.84	
	16.0	22.40	3.41	26.60	3.95	31.00	4.51	32.40	4.67	34.70	4.98	38.70	5.52	42.80	6.07	
	18.0	22.40	3.51	26.60	4.08	31.00	4.65	32.40	4.80	34.70	5.11	38.70	5.67	42.80	6.25	
	20.0	22.40	3.67	26.60	4.25	31.00	4.85	32.40	5.01	34.70	5.32	38.70	5.91	42.80	6.54	
	21.0	22.40	3.75	26.60	4.35	31.00	4.96	32.40	5.10	34.70	5.42	38.70	6.03	42.80	6.67	
	23.0	22.40	3.93	26.60	4.55	31.00	5.19	32.40	5.33	34.70	5.65	38.70	6.29	42.80	6.97	
	25.0	22.40	4.11	26.60	4.75	31.00	5.42	32.40	5.57	34.70	5.88	38.70	6.54	42.80	7.26	
	27.0	22.40	4.41	26.60	5.07	31.00	5.79	32.40	5.93	34.70	6.25	38.70	6.96	42.80	7.74	
	29.0	22.40	4.71	26.60	5.43	31.00	6.19	32.40	6.33	34.70	6.66	38.70	7.41	42.80	8.23	
	31.0	22.40	5.03	26.60	5.78	31.00	6.57	32.40	6.72	34.70	7.06	38.70	7.84	42.80	8.71	
	33.0	22.40	5.37	26.60	6.16	31.00	7.01	32.40	7.15	34.70	7.48	38.70	8.30	42.80	9.24	
	35.0	22.40	5.77	26.60	6.59	31.00	7.49	32.40	7.63	34.70	7.98	38.70	8.83	42.80	9.82	
	37.0	22.40	6.18	26.60	7.04	31.00	7.98	32.40	8.11	34.70	8.46	38.70	9.34	42.80	10.38	
	39.0	22.40	6.76	26.60	7.69	31.00	8.70	32.40	8.83	34.70	9.20	38.70	10.13	42.80	11.24	
	70	10.0	19.90	2.70	23.60	3.14	27.30	3.54	28.40	3.70	30.60	3.96	34.00	4.34	38.10	4.73
		12.0	19.90	2.79	23.60	3.23	27.30	3.66	28.40	3.78	30.60	4.08	34.00	4.47	38.10	4.90
14.0		19.90	2.86	23.60	3.31	27.30	3.75	28.40	3.84	30.60	4.16	34.00	4.58	38.10	5.03	
16.0		19.90	2.98	23.60	3.46	27.30	3.92	28.40	3.98	30.60	4.33	34.00	4.78	38.10	5.27	
18.0		19.90	3.10	23.60	3.58	27.30	4.07	28.40	4.11	30.60	4.47	34.00	4.95	38.10	5.47	
20.0		19.90	3.22	23.60	3.73	27.30	4.22	28.40	4.27	30.60	4.64	34.00	5.13	38.10	5.68	
21.0		19.90	3.30	23.60	3.81	27.30	4.32	28.40	4.37	30.60	4.73	34.00	5.25	38.10	5.81	
23.0		19.90	3.46	23.60	3.99	27.30	4.51	28.40	4.58	30.60	4.93	34.00	5.46	38.10	6.06	
25.0		19.90	3.58	23.60	4.13	27.30	4.68	28.40	4.77	30.60	5.08	34.00	5.63	38.10	6.26	
27.0		19.90	3.79	23.60	4.36	27.30	4.94	28.40	5.02	30.60	5.34	34.00	5.93	38.10	6.59	
29.0		19.90	3.94	23.60	4.52	27.30	5.11	28.40	5.32	30.60	5.52	34.00	6.11	38.10	6.81	
31.0		19.90	4.17	23.60	4.78	27.30	5.40	28.40	5.64	30.60	5.81	34.00	6.43	38.10	7.16	
33.0		19.90	4.46	23.60	5.10	27.30	5.76	28.40	5.95	30.60	6.16	34.00	6.82	38.10	7.59	
35.0		19.90	4.79	23.60	5.46	27.30	6.16	28.40	6.37	30.60	6.56	34.00	7.24	38.10	8.06	
37.0		19.90	5.24	23.60	5.95	27.30	6.71	28.40	6.77	30.60	7.12	34.00	7.83	38.10	8.72	
39.0		19.90	5.69	23.60	6.46	27.30	7.26	28.40	7.38	30.60	7.68	34.00	8.42	38.10	9.37	
60		10.0	17.30	2.32	20.50	2.69	23.60	3.03	24.40	3.12	26.50	3.38	29.50	3.72	33.20	4.06
		12.0	17.30	2.39	20.50	2.77	23.60	3.13	24.40	3.19	26.50	3.47	29.50	3.82	33.20	4.18
	14.0	17.30	2.45	20.50	2.84	23.60	3.20	24.40	3.26	26.50	3.54	29.50	3.92	33.20	4.31	
	16.0	17.30	2.55	20.50	2.94	23.60	3.33	24.40	3.37	26.50	3.67	29.50	4.07	33.20	4.47	
	18.0	17.30	2.65	20.50	3.06	23.60	3.47	24.40	3.50	26.50	3.80	29.50	4.22	33.20	4.66	
	20.0	17.30	2.76	20.50	3.18	23.60	3.59	24.40	3.61	26.50	3.93	29.50	4.38	33.20	4.83	
	21.0	17.30	2.82	20.50	3.24	23.60	3.68	24.40	3.70	26.50	4.02	29.50	4.46	33.20	4.94	
	23.0	17.30	2.96	20.50	3.41	23.60	3.85	24.40	3.88	26.50	4.20	29.50	4.67	33.20	5.18	
	25.0	17.30	3.09	20.50	3.54	23.60	4.01	24.40	4.05	26.50	4.35	29.50	4.84	33.20	5.37	
	27.0	17.30	3.24	20.50	3.73	23.60	4.21	24.40	4.25	26.50	4.55	29.50	5.05	33.20	5.63	
	29.0	17.30	3.40	20.50	3.89	23.60	4.40	24.40	4.47	26.50	4.72	29.50	5.26	33.20	5.85	
	31.0	17.30	3.60	20.50	4.12	23.60	4.65	24.40	4.74	26.50	4.99	29.50	5.54	33.20	6.16	
	33.0	17.30	3.82	20.50	4.36	23.60	4.92	24.40	4.99	26.50	5.25	29.50	5.82	33.20	6.48	
	35.0	17.30	4.11	20.50	4.68	23.60	5.27	24.40	5.33	26.50	5.61	29.50	6.20	33.20	6.89	
	37.0	17.30	4.44	20.50	5.04	23.60	5.67	24.40	5.67	26.50	6.01	29.50	6.63	33.20	7.38	
	39.0	17.30	4.85	20.50	5.49	23.60	6.17	24.40	6.18	26.50	6.51	29.50	7.15	33.20	7.95	
	50	10.0	14.70	1.94	17.30	2.24	20.00	2.52	20.40	2.56	22.40	2.81	25.00	3.11	28.30	3.39
		12.0	14.70	1.98	17.30	2.29	20.00	2.59	20.40	2.62	22.40	2.88	25.00	3.19	28.30	3.50
14.0		14.70	2.04	17.30	2.36	20.00	2.66	20.40	2.69	22.40	2.95	25.00	3.27	28.30	3.60	
16.0		14.70	2.11	17.30	2.43	20.00	2.75	20.40	2.77	22.40	3.04	25.00	3.38	28.30	3.72	
18.0		14.70	2.20	17.30	2.54	20.00	2.87	20.40	2.89	22.40	3.16	25.00	3.51	28.30	3.87	
20.0		14.70	2.28	17.30	2.63	20.00	2.97	20.40	2.97	22.40	3.26	25.00	3.64	28.30	4.02	
21.0		14.70	2.33	17.30	2.68	20.00	3.03	20.40	3.04	22.40	3.32	25.00	3.71	28.30	4.11	
23.0		14.70	2.47	17.30	2.84	20.00	3.20	20.40	3.20	22.40	3.50	25.00	3.90	28.30	4.33	
25.0		14.70	2.58	17.30	2.96	20.00	3.34	20.40	3.34	22.40	3.63	25.00	4.06	28.30	4.50	
27.0		14.70	2.70	17.30	3.09	20.00	3.49	20.40	3.49	22.40	3.78	25.00	4.22	28.30	4.69	
29.0		14.70	2.85	17.30	3.25	20.00	3.67	20.40	3.66	22.40	3.95	25.00	4.41	28.30	4.91	
31.0		14.70	3.02	17.30	3.45	20.00	3.89	20.40	3.87	22.40	4.18	25.00	4.66	28.30	5.18	
33.0		14.70	3.19	17.30	3.62	20.00	4.08	20.40	4.05	22.40	4.37	25.00	4.85	28.30	5.40	
35.0		14.70	3.43	17.30	3.89	20.00	4.38	20.40	4.34	22.40	4.67	25.00	5.18	28.30	5.76	
37.0		14.70	3.67	17.30	4.15	20.00	4.66	20.40	4.62	22.40	4.95	25.00	5.48	28.30	6.10	
39.0		14.70	4.02	17.30	4.53	20.00	5.08	20.40	5.02	22.40	5.37	25.00	5.93	28.30	6.59	

10. Capacity Table

Heating

TC : Total Capacity, PI : Power Input

Combination, % (Capacity index)	Outdoor Air Temp.		Indoor temperature										
			16 (°C, DB)		18 (°C, DB)		20 (°C, DB)		22 (°C, DB)		24 (°C, DB)		
	DB	WB	TC(kW)	PI(kW)	TC(kW)	PI(kW)	TC(kW)	PI(kW)	TC(kW)	PI(kW)	TC(kW)	PI(kW)	
130	15.0	14.0	61.70	9.49	58.10	9.25	54.50	9.14	52.20	9.30	49.90	9.50	
	13.0	12.0	61.60	9.72	58.10	9.48	54.50	9.39	52.20	9.55	49.90	9.75	
	11.0	10.0	61.60	10.00	58.10	9.74	54.50	9.64	52.20	9.81	49.90	10.02	
	9.0	8.0	61.00	10.33	57.60	10.14	54.50	10.12	52.20	10.29	49.90	10.51	
	7.0	6.0	60.10	10.72	57.00	10.63	54.50	10.72	52.20	10.90	49.90	11.14	
	5.0	4.0	59.00	11.24	56.40	11.11	53.80	11.16	52.00	11.59	49.80	12.12	
	3.0	2.0	57.80	11.95	55.20	11.67	53.00	11.58	51.00	11.96	49.10	12.43	
	0.0	-1.0	56.30	13.25	53.60	12.84	51.00	12.62	49.20	13.07	47.40	13.61	
	-3.0	-4.0	55.00	14.46	52.20	14.04	49.80	13.85	48.20	14.23	46.50	14.70	
	-5.0	-6.0	53.10	14.92	50.70	14.56	48.10	14.43	46.60	14.84	45.00	15.34	
	-7.0	-8.0	50.90	15.08	48.70	14.80	46.60	14.76	45.00	15.15	43.40	15.63	
	-10.0	-11.0	48.80	14.79	47.00	14.71	45.10	14.88	43.50	15.25	41.90	15.70	
	-12.0	-13.0	46.60	14.63	45.00	14.59	43.30	14.82	42.20	15.35	40.70	15.99	
	-15.0	-16.0	44.80	14.53	43.40	14.56	42.00	14.85	40.80	15.36	39.70	15.98	
	-17.0	-18.0	42.60	14.26	41.80	14.45	40.90	14.91	39.90	15.62	39.00	16.47	
	-20.0	-21.0	40.90	14.19	40.30	14.47	39.70	15.03	38.50	15.50	37.40	16.07	
	-22.0	-23.0	38.00	13.85	37.30	14.10	36.60	14.62	35.50	15.08	34.40	15.69	
	-25.0	-26.0	33.00	12.97	32.10	13.14	31.20	13.55	30.30	14.00	29.40	14.64	
	120	15.0	14.0	58.50	9.30	54.90	9.03	51.30	8.90	49.00	9.04	46.80	9.22
		13.0	12.0	58.50	9.59	54.90	9.31	51.30	9.16	49.00	9.31	46.80	9.50
11.0		10.0	58.40	9.90	54.80	9.62	51.30	9.49	49.00	9.63	46.80	9.83	
9.0		8.0	58.40	10.40	54.80	10.10	51.30	9.96	49.00	10.11	46.80	10.32	
7.0		6.0	58.40	11.00	54.90	10.68	51.30	10.53	49.00	10.69	46.80	10.91	
5.0		4.0	58.40	11.70	54.90	11.37	51.30	11.21	49.10	11.38	46.80	11.61	
3.0		2.0	57.00	12.47	54.30	12.20	51.20	12.13	49.00	12.34	46.80	12.60	
0.0		-1.0	56.00	13.59	53.10	13.18	50.50	12.96	48.90	13.46	46.80	14.06	
-3.0		-4.0	54.60	14.24	52.20	13.92	49.60	13.52	48.10	14.08	46.20	14.76	
-5.0		-6.0	53.10	14.64	50.60	14.54	48.30	13.88	46.60	14.36	44.40	14.94	
-7.0		-8.0	51.60	15.23	49.40	14.84	46.60	14.02	45.30	14.47	43.50	15.03	
-10.0		-11.0	49.60	15.65	46.80	15.22	44.00	14.33	42.90	14.86	41.40	15.49	
-12.0		-13.0	47.80	15.52	44.60	15.29	42.40	14.66	41.10	15.08	40.10	15.60	
-15.0		-16.0	45.10	15.45	43.20	15.42	41.20	14.92	39.90	15.52	38.70	16.26	
-17.0		-18.0	43.10	15.19	41.10	15.35	39.80	15.11	38.50	15.70	37.70	16.42	
-20.0		-21.0	41.10	15.42	39.90	15.30	38.50	15.44	36.90	16.03	35.70	16.74	
-22.0		-23.0	38.40	15.09	37.00	14.94	35.60	15.05	34.10	15.63	33.00	16.38	
-25.0		-26.0	33.50	14.17	32.00	13.98	30.50	14.01	29.30	14.57	28.30	15.35	
110		15.0	14.0	56.10	9.12	52.60	8.84	49.10	8.70	46.90	8.82	44.60	8.97
		13.0	12.0	56.20	9.42	52.60	9.13	49.10	8.98	46.90	9.10	44.60	9.27
	11.0	10.0	56.20	9.80	52.70	9.50	49.10	9.34	46.90	9.47	44.60	9.64	
	9.0	8.0	56.20	10.29	52.70	9.97	49.10	9.81	46.90	9.94	44.60	10.12	
	7.0	6.0	56.20	10.86	52.70	10.53	49.10	10.35	46.90	10.49	44.60	10.68	
	5.0	4.0	56.00	11.37	52.50	11.02	49.00	10.83	46.80	10.99	44.60	11.21	
	3.0	2.0	54.80	12.07	52.20	11.76	49.00	11.64	46.80	11.81	44.60	12.04	
	0.0	-1.0	53.20	12.55	51.40	12.53	49.00	12.73	46.80	12.92	44.60	13.16	
	-3.0	-4.0	51.90	13.26	49.60	13.22	47.30	13.42	45.90	13.86	43.70	14.40	
	-5.0	-6.0	50.50	14.03	48.00	13.95	46.10	14.12	45.00	14.62	43.40	15.24	
	-7.0	-8.0	49.00	14.53	46.60	14.58	44.70	14.91	43.30	15.31	41.80	15.82	
	-10.0	-11.0	47.10	15.25	44.80	15.09	42.90	15.26	41.70	15.75	40.10	16.35	
	-12.0	-13.0	45.50	15.32	43.20	15.10	41.30	15.17	40.20	15.66	38.60	16.26	
	-15.0	-16.0	44.10	15.51	42.10	15.47	40.20	15.61	39.10	16.14	37.60	16.77	
	-17.0	-18.0	42.00	15.37	40.40	15.32	38.70	15.48	37.90	16.07	36.20	16.79	
	-20.0	-21.0	40.70	15.49	39.00	15.37	37.40	15.51	36.40	16.06	34.80	16.73	
	-22.0	-23.0	37.70	15.06	36.00	14.92	34.30	15.03	33.40	15.57	31.90	16.27	
	-25.0	-26.0	32.50	13.99	30.70	13.79	29.00	13.81	28.20	14.33	26.90	15.05	
	100	15.0	14.0	52.00	8.72	48.50	8.41	45.00	8.23	42.80	8.30	40.60	8.44
		13.0	12.0	52.00	9.04	48.50	8.72	45.00	8.53	42.80	8.61	40.60	8.74
11.0		10.0	52.00	9.47	48.50	9.14	45.00	8.93	42.80	9.02	40.60	9.16	
9.0		8.0	52.00	9.95	48.50	9.60	45.00	9.38	42.80	9.47	40.60	9.62	
7.0		6.0	52.00	10.47	48.50	10.10	45.00	9.88	42.80	9.97	40.60	10.13	
5.0		4.0	52.00	10.76	48.50	10.38	45.00	10.15	42.80	10.24	40.60	10.41	
3.0		2.0	52.00	11.38	48.50	10.97	45.00	10.73	42.80	10.83	40.60	11.01	
0.0		-1.0	51.60	11.98	48.30	11.60	45.00	11.39	42.80	11.49	40.60	11.68	
-3.0		-4.0	50.40	12.45	47.70	12.19	45.00	12.13	42.80	12.24	40.60	12.44	
-5.0		-6.0	48.50	13.16	46.30	12.98	44.10	13.03	42.30	13.15	40.10	13.33	
-7.0		-8.0	47.10	13.54	45.10	13.41	43.10	13.51	41.40	14.07	39.30	14.28	
-10.0		-11.0	44.70	14.62	42.90	14.65	41.60	14.94	39.50	15.08	37.40	15.28	
-12.0		-13.0	43.00	14.88	41.50	14.98	39.90	15.36	37.90	15.50	35.90	15.71	
-15.0		-16.0	41.80	15.66	40.70	15.68	38.90	16.10	36.90	16.25	35.00	16.46	
-17.0		-18.0	39.70	15.67	38.40	15.66	37.10	15.94	35.00	16.09	33.40	16.30	
-20.0		-21.0	38.00	15.96	36.50	15.83	34.90	15.97	33.00	15.74	31.40	16.33	
-22.0		-23.0	35.00	15.55	33.40	15.40	31.80	15.51	30.10	15.30	28.60	15.93	
-25.0		-26.0	29.70	14.45	28.00	14.24	26.30	14.26	24.90	14.08	23.70	14.77	

10. Capacity Table

Heating

TC : Total Capacity, PI : Power Input

Combination, % (Capacity index)	Outdoor Air Temp.		Indoor temperature										
			16 (°C, DB)		18 (°C, DB)		20 (°C, DB)		22 (°C, DB)		24 (°C, DB)		
	DB	WB	TC(kW)	PI(kW)	TC(kW)	PI(kW)	TC(kW)	PI(kW)	TC(kW)	PI(kW)	TC(kW)	PI(kW)	
90	15.0	14.0	46.80	7.99	43.70	7.71	40.50	7.54	38.50	7.61	36.60	7.73	
	13.0	12.0	46.80	8.27	43.70	7.98	40.50	7.80	38.50	7.88	36.60	8.00	
	11.0	10.0	46.80	8.59	43.70	8.29	40.50	8.11	38.50	8.18	36.60	8.31	
	9.0	8.0	46.80	9.02	43.70	8.70	40.50	8.51	38.50	8.59	36.60	8.73	
	7.0	6.0	46.80	9.49	43.70	9.15	40.50	8.95	38.50	9.03	36.60	9.18	
	5.0	4.0	46.80	9.87	43.70	9.52	40.50	9.31	38.50	9.40	36.60	9.55	
	3.0	2.0	46.80	10.34	43.70	9.98	40.50	9.76	38.50	9.85	36.60	10.01	
	0.0	-1.0	46.80	11.05	43.70	10.66	40.50	10.42	38.50	10.52	36.60	10.69	
	-3.0	-4.0	46.80	11.78	43.70	11.36	40.50	11.11	38.50	11.22	36.60	11.40	
	-5.0	-6.0	46.20	12.07	43.40	11.96	40.50	12.06	38.50	12.17	36.60	12.37	
	-7.0	-8.0	45.30	12.27	42.40	12.50	40.40	12.98	38.40	13.10	36.40	13.32	
	-10.0	-11.0	43.20	12.47	40.80	13.13	39.10	14.03	37.80	13.21	35.60	13.42	
	-12.0	-13.0	40.50	12.69	38.40	13.41	37.30	14.37	35.40	13.44	33.60	13.65	
	-15.0	-16.0	38.80	13.32	37.50	13.96	36.10	14.85	33.90	13.47	32.20	13.68	
	-17.0	-18.0	36.70	13.74	35.60	14.39	34.10	15.33	32.50	13.72	30.60	13.94	
	-20.0	-21.0	34.30	14.22	33.40	14.80	32.10	15.70	30.10	14.21	28.50	14.10	
	-22.0	-23.0	31.40	13.75	30.40	14.29	29.10	15.12	27.30	13.70	25.80	13.64	
	-25.0	-26.0	26.40	12.60	25.30	13.01	23.90	13.68	22.40	12.41	21.20	12.43	
	80	15.0	14.0	41.60	7.27	38.80	7.01	36.00	6.86	34.20	6.92	32.50	7.03
		13.0	12.0	41.60	7.51	38.80	7.24	36.00	7.08	34.20	7.15	32.50	7.26
11.0		10.0	41.60	7.71	38.80	7.44	36.00	7.28	34.20	7.34	32.50	7.46	
9.0		8.0	41.60	8.10	38.80	7.81	36.00	7.64	34.20	7.71	32.50	7.83	
7.0		6.0	41.60	8.50	38.80	8.20	36.00	8.02	34.20	8.09	32.50	8.22	
5.0		4.0	41.60	8.99	38.80	8.67	36.00	8.48	34.20	8.56	32.50	8.70	
3.0		2.0	41.60	9.31	38.80	8.98	36.00	8.78	34.20	8.86	32.50	9.01	
0.0		-1.0	41.60	10.03	38.80	9.67	36.00	9.46	34.20	9.55	32.50	9.70	
-3.0		-4.0	41.60	10.43	38.80	10.16	36.00	10.11	34.20	10.20	32.50	10.36	
-5.0		-6.0	40.40	10.60	38.40	10.54	36.00	10.69	34.20	10.79	32.50	10.96	
-7.0		-8.0	39.20	10.66	37.50	10.83	35.90	11.18	34.10	11.28	32.40	11.46	
-10.0		-11.0	37.40	10.96	36.30	11.14	34.60	11.50	32.80	11.60	31.20	11.79	
-12.0		-13.0	36.10	11.01	34.40	11.27	33.10	11.76	31.40	11.87	29.80	12.06	
-15.0		-16.0	34.40	11.64	33.10	11.82	31.90	12.22	30.50	12.06	28.90	12.25	
-17.0		-18.0	33.00	11.94	31.90	12.15	30.70	12.60	29.60	12.49	27.80	12.69	
-20.0		-21.0	31.50	12.22	30.50	12.48	29.60	12.99	27.90	12.41	26.80	12.61	
-22.0		-23.0	28.90	11.80	27.90	12.02	26.80	12.48	25.30	11.94	24.30	12.16	
-25.0		-26.0	24.40	10.78	23.20	10.92	22.10	11.25	20.90	10.78	19.90	11.02	
70		15.0	14.0	36.40	6.37	34.00	6.15	31.50	6.01	29.90	6.07	28.40	6.16
		13.0	12.0	36.40	6.56	34.00	6.32	31.50	6.19	29.90	6.24	28.40	6.34
	11.0	10.0	36.40	6.73	34.00	6.49	31.50	6.35	29.90	6.41	28.40	6.51	
	9.0	8.0	36.40	7.02	34.00	6.77	31.50	6.62	29.90	6.68	28.40	6.79	
	7.0	6.0	36.40	7.34	34.00	7.08	31.50	6.93	29.90	6.99	28.40	7.10	
	5.0	4.0	36.40	7.74	34.00	7.47	31.50	7.30	29.90	7.37	28.40	7.49	
	3.0	2.0	36.40	8.03	34.00	7.75	31.50	7.58	29.90	7.65	28.40	7.77	
	0.0	-1.0	36.40	8.62	34.00	8.31	31.50	8.13	29.90	8.21	28.40	8.34	
	-3.0	-4.0	36.40	9.20	34.00	8.87	31.50	8.68	29.90	8.76	28.40	8.90	
	-5.0	-6.0	35.90	9.56	33.70	9.32	31.50	9.22	29.90	9.31	28.40	9.46	
	-7.0	-8.0	35.40	9.75	33.50	9.65	31.40	9.72	29.80	9.81	28.30	9.97	
	-10.0	-11.0	34.70	9.92	32.80	10.03	31.30	10.25	29.70	10.34	28.30	10.51	
	-12.0	-13.0	33.50	10.19	32.20	10.31	30.90	10.54	29.40	11.09	28.20	11.01	
	-15.0	-16.0	32.90	10.62	31.60	10.87	30.70	11.34	29.20	11.45	27.70	11.63	
	-17.0	-18.0	31.70	11.11	30.50	11.37	29.60	11.87	28.10	11.98	26.70	12.17	
	-20.0	-21.0	30.20	11.31	29.60	11.58	28.70	12.08	27.30	12.20	25.90	12.39	
	-22.0	-23.0	27.60	10.39	27.00	11.08	26.00	11.52	24.60	11.57	23.20	11.72	
	-25.0	-26.0	23.20	9.79	22.40	9.93	21.30	10.24	19.90	10.16	18.50	10.20	
	60	15.0	14.0	31.20	5.47	29.10	5.28	27.00	5.16	25.70	5.21	24.40	5.30
		13.0	12.0	31.20	5.61	29.10	5.41	27.00	5.29	25.70	5.34	24.40	5.43
11.0		10.0	31.20	5.75	29.10	5.55	27.00	5.43	25.70	5.48	24.40	5.57	
9.0		8.0	31.20	5.94	29.10	5.73	27.00	5.60	25.70	5.66	24.40	5.75	
7.0		6.0	31.20	6.19	29.10	5.97	27.00	5.84	25.70	5.90	24.40	5.99	
5.0		4.0	31.20	6.51	29.10	6.28	27.00	6.14	25.70	6.19	24.40	6.29	
3.0		2.0	31.20	6.77	29.10	6.53	27.00	6.38	25.70	6.44	24.40	6.54	
0.0		-1.0	31.20	7.23	29.10	6.97	27.00	6.82	25.70	6.88	24.40	6.99	
-3.0		-4.0	31.20	7.70	29.10	7.43	27.00	7.27	25.70	7.33	24.40	7.45	
-5.0		-6.0	31.10	8.21	29.10	7.93	27.00	7.77	25.70	7.84	24.40	7.96	
-7.0		-8.0	30.30	8.55	28.90	8.34	26.90	8.27	25.60	8.35	24.30	8.48	
-10.0		-11.0	29.90	8.82	28.40	8.73	26.80	8.80	25.50	8.88	24.20	9.02	
-12.0		-13.0	29.30	9.25	27.90	9.28	26.80	9.48	25.40	9.57	24.10	9.72	
-15.0		-16.0	29.00	10.07	28.00	10.25	27.30	10.63	25.90	10.73	24.60	10.90	
-17.0		-18.0	28.70	10.59	27.90	10.85	27.30	11.32	26.00	11.43	24.70	11.61	
-20.0		-21.0	28.30	10.92	27.40	11.18	26.90	11.67	25.50	11.78	24.30	11.97	
-22.0		-23.0	25.50	10.29	24.60	10.50	24.00	10.91	22.60	10.95	21.30	11.07	
-25.0		-26.0	20.80	8.96	19.80	9.05	19.00	9.30	17.60	9.19	16.40	9.19	

10. Capacity Table

Heating

TC : Total Capacity, PI : Power Input

Combination, % (Capacity index)	Outdoor Air Temp.		Indoor temperature									
			16 (°C, DB)		18 (°C, DB)		20 (°C, DB)		22 (°C, DB)		24 (°C, DB)	
	DB	WB	TC(kW)	PI(kW)	TC(kW)	PI(kW)	TC(kW)	PI(kW)	TC(kW)	PI(kW)	TC(kW)	PI(kW)
50	15.0	14.0	25.90	4.58	24.20	4.42	22.50	4.33	21.40	4.41	20.30	4.54
	13.0	12.0	25.90	4.65	24.20	4.48	22.50	4.39	21.40	4.48	20.30	4.61
	11.0	10.0	25.90	4.75	24.20	4.59	22.50	4.49	21.40	4.58	20.30	4.71
	9.0	8.0	25.90	4.81	24.20	4.65	22.50	4.55	21.40	4.64	20.30	4.78
	7.0	6.0	25.90	4.98	24.20	4.81	22.50	4.70	21.40	4.80	20.30	4.94
	5.0	4.0	25.90	5.19	24.20	5.01	22.50	4.90	21.40	5.00	20.30	5.15
	3.0	2.0	25.90	5.42	24.20	5.23	22.50	5.12	21.40	5.23	20.30	5.38
	0.0	-1.0	25.90	5.74	24.20	5.54	22.50	5.42	21.40	5.53	20.30	5.69
	-3.0	-4.0	25.90	6.10	24.20	5.89	22.50	5.76	21.40	5.88	20.30	6.05
	-5.0	-6.0	25.90	6.59	24.20	6.36	22.50	6.23	21.40	6.36	20.30	6.54
	-7.0	-8.0	25.90	7.17	24.10	6.93	22.40	6.78	21.30	6.92	20.20	7.12
	-10.0	-11.0	25.80	7.62	24.10	7.36	22.40	7.20	21.20	7.35	20.20	7.56
	-12.0	-13.0	25.70	8.13	24.00	7.85	22.30	7.68	21.20	7.84	20.10	8.06
	-15.0	-16.0	26.20	8.91	24.50	8.60	22.70	8.42	21.60	8.59	20.50	8.84
	-17.0	-18.0	26.60	9.75	24.80	9.42	23.00	9.22	21.90	9.41	20.80	9.68
	-20.0	-21.0	26.90	10.74	25.10	10.37	23.40	10.15	22.20	10.36	21.10	10.65
	-22.0	-23.0	23.70	9.88	22.00	9.49	20.30	9.24	19.10	9.35	18.00	9.57
	-25.0	-26.0	18.30	8.13	16.60	7.70	15.00	7.37	13.90	7.31	12.80	7.34

11. Capacity Correction

AM040KXMDEH/EU, AM050KXMDEH/EU

Cooling



		Pipe Length (m)				
		10	20	30	40	50
Level Difference (m)	15	-	0.98	0.96	0.95	0.93
	10	1.00	0.98	0.96	0.95	0.93
	0	1.00	0.98	0.96	0.95	0.93
	-10	1.00	0.98	0.96	0.94	0.93
	-15	-	0.98	0.96	0.94	0.92

Heating



		Pipe Length (m)					
		7.5	10	20	30	40	50
Level Difference (m)	15	-	-	0.99	0.99	0.98	0.98
	10	-	1.00	0.99	0.99	0.98	0.98
	0	1.00	1.00	0.99	0.99	0.98	0.98
	-10	-	1.00	0.99	0.99	0.98	0.98
	-15	-	-	0.99	0.99	0.98	0.98

11. Capacity Correction

AM080FXMDGH/EU, AM080MXMDGH/EU

Cooling



		Pipe Length (m)													
		8	10	20	30	40	50	60	70	80	90	100	110	120	130
Level Difference (m)	30	-	-	-	0.96	0.95	0.94	0.92	0.91	0.90	0.90	0.89	0.87	0.86	0.85
	20	-	-	0.98	0.97	0.95	0.94	0.92	0.91	0.90	0.90	0.89	0.88	0.87	0.85
	10	-	0.99	0.98	0.97	0.95	0.94	0.93	0.91	0.90	0.90	0.89	0.88	0.87	0.86
	0	1.00	1.00	0.98	0.97	0.96	0.94	0.93	0.92	0.90	0.90	0.89	0.88	0.87	0.86
	-10	-	1.00	0.98	0.97	0.96	0.94	0.93	0.92	0.90	0.91	0.89	0.88	0.87	0.86
	-20	-	-	0.99	0.97	0.96	0.95	0.93	0.92	0.91	0.91	0.90	0.88	0.87	0.86
	-30	-	-	-	0.98	0.96	0.95	0.93	0.92	0.91	0.91	0.90	0.89	0.88	0.86

Heating



		Pipe Length (m)													
		8	10	20	30	40	50	60	70	80	90	100	110	120	130
Level Difference (m)	30	-	-	-	0.98	0.97	0.97	0.96	0.95	0.95	0.95	0.94	0.94	0.93	0.93
	20	-	-	0.99	0.98	0.97	0.97	0.96	0.95	0.95	0.95	0.94	0.94	0.93	0.93
	10	-	0.99	0.99	0.98	0.97	0.97	0.96	0.95	0.95	0.95	0.94	0.94	0.93	0.93
	0	1.00	0.99	0.99	0.98	0.97	0.97	0.96	0.95	0.95	0.95	0.94	0.94	0.93	0.93
	-10	-	0.99	0.99	0.98	0.97	0.97	0.96	0.95	0.95	0.95	0.94	0.94	0.93	0.93
	-20	-	-	0.99	0.98	0.97	0.97	0.96	0.95	0.95	0.95	0.94	0.94	0.93	0.93
	-30	-	-	-	0.98	0.97	0.97	0.96	0.95	0.95	0.95	0.94	0.94	0.93	0.93

11. Capacity Correction

AM100KXMDGH/EU

Cooling



		Pipe Length (m)																
		8	10	20	30	40	50	60	70	80	90	100	110	120	130	140	150	160
Level Difference (m)	50	-	-	-	-	-	0.94	0.93	0.92	0.92	0.92	0.91	0.90	0.89	0.88	0.88	0.87	0.86
	40	-	-	-	-	0.95	0.95	0.94	0.93	0.92	0.92	0.91	0.90	0.89	0.89	0.88	0.87	0.86
	30	-	-	-	0.97	0.96	0.95	0.94	0.93	0.92	0.92	0.91	0.91	0.90	0.89	0.88	0.87	0.86
	20	-	-	0.98	0.97	0.96	0.95	0.94	0.93	0.92	0.92	0.92	0.91	0.90	0.89	0.88	0.87	0.87
	10	-	0.99	0.98	0.97	0.96	0.95	0.94	0.93	0.92	0.93	0.92	0.91	0.90	0.89	0.88	0.88	0.87
	0	0.99	0.99	0.98	0.97	0.96	0.95	0.94	0.93	0.93	0.93	0.92	0.91	0.90	0.89	0.89	0.88	0.87
	-10	-	0.99	0.98	0.97	0.96	0.95	0.94	0.93	0.93	0.92	0.91	0.90	0.90	0.89	0.88	0.88	0.87
	-20	-	-	0.99	0.98	0.97	0.96	0.95	0.94	0.93	0.93	0.92	0.91	0.91	0.90	0.89	0.88	0.87
	-30	-	-	-	0.98	0.97	0.96	0.95	0.94	0.93	0.93	0.92	0.92	0.91	0.90	0.89	0.88	0.88
	-40	-	-	-	-	0.97	0.96	0.95	0.94	0.93	0.94	0.93	0.92	0.91	0.90	0.89	0.89	0.88

Heating



		Pipe Length (m)																
		8	10	20	30	40	50	60	70	80	90	100	110	120	130	140	150	160
Level Difference (m)	50	-	-	-	-	-	0.98	0.97	0.97	0.96	0.97	0.96	0.96	0.95	0.95	0.95	0.94	0.94
	40	-	-	-	-	0.98	0.98	0.97	0.97	0.96	0.97	0.96	0.96	0.95	0.95	0.95	0.94	0.94
	30	-	-	-	0.99	0.98	0.98	0.97	0.97	0.96	0.97	0.96	0.96	0.95	0.95	0.95	0.94	0.94
	20	-	-	0.99	0.99	0.98	0.98	0.97	0.97	0.96	0.97	0.96	0.96	0.95	0.95	0.95	0.94	0.94
	10	-	1.00	0.99	0.99	0.98	0.98	0.97	0.97	0.96	0.97	0.96	0.96	0.95	0.95	0.95	0.94	0.94
	0	1.00	1.00	0.99	0.99	0.98	0.98	0.97	0.97	0.96	0.97	0.96	0.96	0.95	0.95	0.95	0.94	0.94
	-10	-	1.00	0.99	0.99	0.98	0.98	0.97	0.97	0.96	0.97	0.96	0.96	0.95	0.95	0.95	0.94	0.94
	-20	-	-	0.99	0.99	0.98	0.98	0.97	0.97	0.96	0.97	0.96	0.96	0.95	0.95	0.95	0.94	0.94
	-30	-	-	-	0.99	0.98	0.98	0.97	0.97	0.96	0.97	0.96	0.96	0.95	0.95	0.95	0.94	0.94
	-40	-	-	-	-	0.98	0.98	0.97	0.97	0.96	0.97	0.96	0.96	0.95	0.95	0.95	0.94	0.94

AM120KXMDGH/EU

Cooling



		Pipe Length (m)																
		8	10	20	30	40	50	60	70	80	90	100	110	120	130	140	150	160
Level Difference (m)	50	-	-	-	-	-	0.96	0.95	0.94	0.94	0.93	0.92	0.92	0.91	0.90	0.90	0.89	0.88
	40	-	-	-	-	0.97	0.96	0.95	0.94	0.93	0.93	0.92	0.92	0.91	0.91	0.90	0.89	0.89
	30	-	-	-	0.97	0.97	0.96	0.95	0.95	0.94	0.93	0.93	0.92	0.92	0.91	0.90	0.90	0.89
	20	-	-	0.98	0.98	0.97	0.96	0.96	0.95	0.94	0.94	0.93	0.92	0.92	0.91	0.90	0.90	0.89
	10	-	0.99	0.98	0.98	0.97	0.97	0.96	0.95	0.95	0.94	0.93	0.93	0.92	0.91	0.91	0.90	0.89
	0	1.00	0.99	0.99	0.98	0.97	0.97	0.96	0.95	0.95	0.94	0.93	0.93	0.92	0.91	0.91	0.90	0.89
	-10	-	1.00	0.99	0.98	0.98	0.97	0.96	0.96	0.95	0.94	0.94	0.93	0.92	0.92	0.91	0.90	0.90
	-20	-	-	0.99	0.98	0.98	0.97	0.96	0.96	0.95	0.94	0.94	0.93	0.93	0.92	0.91	0.91	0.90
	-30	-	-	-	0.99	0.98	0.97	0.97	0.96	0.95	0.95	0.94	0.93	0.93	0.92	0.91	0.91	0.90
	-40	-	-	-	-	0.98	0.97	0.97	0.96	0.96	0.95	0.94	0.94	0.93	0.92	0.92	0.91	0.90

Heating



		Pipe Length (m)																
		8	10	20	30	40	50	60	70	80	90	100	110	120	130	140	150	160
Level Difference (m)	50	-	-	-	-	-	0.98	0.98	0.98	0.97	0.97	0.97	0.97	0.96	0.96	0.96	0.95	0.95
	40	-	-	-	-	0.99	0.98	0.98	0.98	0.97	0.97	0.97	0.97	0.96	0.96	0.96	0.95	0.95
	30	-	-	-	0.99	0.99	0.98	0.98	0.98	0.97	0.97	0.97	0.97	0.96	0.96	0.96	0.95	0.95
	20	-	-	0.99	0.99	0.99	0.98	0.98	0.98	0.97	0.97	0.97	0.97	0.96	0.96	0.96	0.95	0.95
	10	-	1.00	0.99	0.99	0.99	0.98	0.98	0.98	0.97	0.97	0.97	0.97	0.96	0.96	0.96	0.95	0.95
	0	1.00	1.00	0.99	0.99	0.99	0.98	0.98	0.98	0.97	0.97	0.97	0.97	0.96	0.96	0.96	0.95	0.95
	-10	-	1.00	0.99	0.99	0.99	0.98	0.98	0.98	0.97	0.97	0.97	0.97	0.96	0.96	0.96	0.95	0.95
	-20	-	-	0.99	0.99	0.99	0.98	0.98	0.98	0.97	0.97	0.97	0.97	0.96	0.96	0.96	0.95	0.95
	-30	-	-	-	0.99	0.99	0.98	0.98	0.98	0.97	0.97	0.97	0.97	0.96	0.96	0.96	0.95	0.95
	-40	-	-	-	-	0.99	0.98	0.98	0.98	0.97	0.97	0.97	0.97	0.96	0.96	0.96	0.95	0.95

11. Capacity Correction

AM140KXMDGH/EU

Cooling



		Pipe Length (m)																
		8	10	20	30	40	50	60	70	80	90	100	110	120	130	140	150	160
Level Difference (m)	50	-	-	-	-	-	0.95	0.94	0.93	0.92	0.91	0.90	0.89	0.89	0.88	0.87	0.86	0.85
	40	-	-	-	-	0.96	0.95	0.94	0.93	0.92	0.91	0.90	0.89	0.88	0.87	0.86	0.85	
	30	-	-	-	0.97	0.96	0.95	0.94	0.93	0.92	0.92	0.91	0.90	0.89	0.88	0.87	0.86	0.85
	20	-	-	0.98	0.97	0.96	0.95	0.94	0.94	0.93	0.92	0.91	0.90	0.89	0.88	0.87	0.87	0.86
	10	-	0.99	0.98	0.97	0.96	0.95	0.95	0.94	0.93	0.92	0.91	0.90	0.89	0.88	0.88	0.87	0.86
	0	0.99	0.99	0.98	0.97	0.97	0.96	0.95	0.94	0.93	0.92	0.91	0.90	0.90	0.89	0.88	0.87	0.86
	-10	-	0.99	0.98	0.98	0.97	0.96	0.95	0.94	0.93	0.92	0.91	0.91	0.90	0.89	0.88	0.87	0.86
	-20	-	-	0.99	0.98	0.97	0.96	0.95	0.94	0.93	0.93	0.92	0.91	0.90	0.89	0.88	0.87	0.86
	-30	-	-	-	0.98	0.97	0.96	0.95	0.94	0.94	0.93	0.92	0.91	0.90	0.89	0.88	0.88	0.87
	-40	-	-	-	-	0.97	0.96	0.96	0.95	0.94	0.93	0.92	0.91	0.90	0.89	0.89	0.88	0.88

Heating



		Pipe Length (m)																
		8	10	20	30	40	50	60	70	80	90	100	110	120	130	140	150	160
Level Difference (m)	50	-	-	-	-	-	0.98	0.97	0.97	0.97	0.96	0.96	0.95	0.95	0.95	0.94	0.94	0.93
	40	-	-	-	-	0.98	0.98	0.97	0.97	0.97	0.96	0.96	0.95	0.95	0.95	0.94	0.94	0.93
	30	-	-	-	0.99	0.98	0.98	0.97	0.97	0.97	0.96	0.96	0.95	0.95	0.95	0.94	0.94	0.93
	20	-	-	0.99	0.99	0.98	0.98	0.97	0.97	0.97	0.96	0.96	0.95	0.95	0.95	0.94	0.94	0.93
	10	-	1.00	0.99	0.99	0.98	0.98	0.97	0.97	0.97	0.96	0.96	0.95	0.95	0.95	0.94	0.94	0.93
	0	1.00	1.00	0.99	0.99	0.98	0.98	0.97	0.97	0.97	0.96	0.96	0.95	0.95	0.95	0.94	0.94	0.93
	-10	-	1.00	0.99	0.99	0.98	0.98	0.97	0.97	0.97	0.96	0.96	0.95	0.95	0.95	0.94	0.94	0.93
	-20	-	-	0.99	0.99	0.98	0.98	0.97	0.97	0.97	0.96	0.96	0.95	0.95	0.95	0.94	0.94	0.93
	-30	-	-	-	0.99	0.98	0.98	0.97	0.97	0.97	0.96	0.96	0.95	0.95	0.95	0.94	0.94	0.93
	-40	-	-	-	-	0.98	0.98	0.97	0.97	0.97	0.96	0.96	0.95	0.95	0.95	0.94	0.94	0.93

11. Capacity Correction

Silent function correction factor

Cooling

Silent Function	Outdoor Air Temperature (°C DB)							
	0		20		35		45	
	Capacity	Power Input	Capacity	Power Input	Capacity	Power Input	Capacity	Power Input
Level 1	1.00	1.00	1.00	1.00	1.00	1.40	0.77	1.23
Level 2	1.00	1.00	1.00	0.90	0.89	1.06	0.75	1.19
Level 3	1.00	1.00	1.00	0.74	0.77	0.84	0.70	1.05

Heating

Silent Function	Outdoor Air Temperature (°C DB)							
	-15		2		7		15	
	Capacity	Power Input	Capacity	Power Input	Capacity	Power Input	Capacity	Power Input
Level 1	0.53	0.58	0.54	0.84	0.77	0.97	0.73	0.90
Level 2	0.43	0.45	0.44	0.59	0.71	0.61	0.64	0.63
Level 3	0.26	0.27	0.35	0.45	0.58	0.45	0.50	0.46

* In case of AM080FXMDGH/EU model, it has the Silent Function mode in Cooling mode only.

12. Installation

Specification of the circuit breaker and power cable

DVM S ECO Series

Capacity (HP)	Model	MCA (A)	MFA (A)
4	AM040KXMDEH	24.0	32.0
5	AM050KXMDEH	27.0	40.0
4	AM040FXMDEH	22.0	32.0
5	AM050FXMDEH	24.0	32.0
6	AM060FXMDEH	32.0	40.0
4	AM040FXMDGH	10.0	20.0
5	AM050FXMDGH	12.0	20.0
6	AM060FXMDGH	12.0	20.0
8	AM080FXMDGH	18.0	25.0
8	AM080MXMDGH	18.4	25.0
10	AM100KXMDGH	21.5	30.0
12	AM120KXMDGH	23.5	30.0
14	AM140KXMDGH	32.0	40.0

* MCA: Minimum Circuit Ampere;

* MFA: Maximum Fuse Ampere

* Please refer to the MCA specification to selecte the line parameter.

* Please refer to the MFA specification to selecte the MCCB and ELB specification.

* Power Supply cords of parts of appliances for outdoor use shall not be lighter than polychloroprene sheathed flexible cord. (Code designation IEC:60245 IEC 66 / CENELEC: H07RN-F)

- This device is intended for the connection to a power supply system with a maximum permissible system impedance shown in the table (on the left page) at the interface point (power service box) of the user's supply.
- The user must ensure that this device is connected only to a power supply system which fulfills the requirement above. If necessary, the user can ask the public power supply company for the system impedance at the interface point.
- This equipment complies with IEC 61000-3-12 provided that the short-circuit power S_{sc} is greater than or equal to $S_{sc}(*2)$ at the interface point between the user's supply and the public system. It is the responsibility of the installer or user of the equipment to ensure, by consultation with the distribution network operator if necessary, that the equipment is connected only to a supply with a short-circuit power S_{sc} greater than or equal to $S_{sc}(*2)$.
- [$S_{sc}(*2)$]

Capacity (HP)	Model	S_{sc} [MVA]
4	AM040KXMDEH	-
5	AM050KXMDEH	-
4	AM040FXMDEH	-
5	AM050FXMDEH	-
6	AM060FXMDEH	-
4	AM040FXMDGH	3.3
5	AM050FXMDGH	3.3
6	AM060FXMDGH	3.3
8	AM080FXMDGH	3.4
8	AM080MXMDGH	3.4
10	AM100KXMDGH	4.6
12	AM120KXMDGH	5.1
14	AM140KXMDGH	5.9

12. Installation



Caution for electrical work

- You must install ELCB or MCCB + ELB
 - ELCB: Earth leakage breaker
 - MCCB: Molded case circuit breaker
 - ELB: Earth leakage breaker
- Do not operate the outdoor unit before completing the refrigerant pipe work.
- Do not disconnect or change the cable inside the product. It may cause damage to the product.
- Specification of the power cable is selected based on following installation condition; culvert installation/ ambient temperature 30 °C/ single multi conductor cables. If the condition is different from the ones stated, please consult an electrical installation expert and re-select the power cable.
 - If the length of power cable exceed 50m, re-select the power cable considering the voltage drop.
- Use a power cable made out of incombustible material for the insulator (inner cover) and the sheath (outer cover).
- Do not use the power cable with the core wire exposed due to insulator damage occurred during removal of the sheath. When the core wire is exposed, it may cause fire.
- When you install the power and communication cables, be careful not to touch on the refrigerant pipes. It can damage on the cables because of the high temperature of the non-insulated refrigerant pipes.

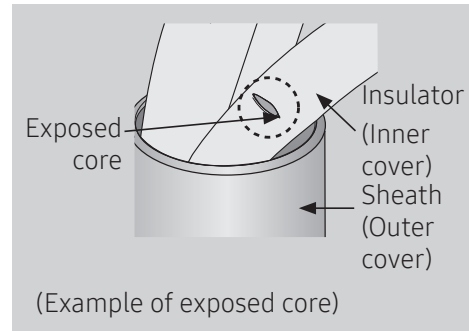

Specification of the protection tube

Name	Temper grade	Applicable conditions
Flexible PVC conduit	PVC	When the protection tube is installed indoor and not exposed to outside, because it is embedded in concrete structure
Class 1 flexible conduit	Galvanized steel sheet	When the protection tube is installed indoor but exposed to outside so there are risk of damage to the protection tube
Class 1 PVC coated flexible conduit	Galvanized steel sheet and Soft PVC compound	When the protection tube is installed outdoor and exposed to outside so there are risk of damage to the protection tube and extra waterproof is needed



Caution for perforating the knock-out hole

- Perforate a knock-out hole by punching it with a hammer.
- After perforating the knock-out hole, apply rust resisting paint around the hole.
- When you need to pass the cables through the knock-out hole, remove burrs on the hole and protection the cable with a protection tape or bushing etc.

Caution for installing communication cable

- When you connect the cable, it may sag and pressed by other parts. Therefore cables should be fixed to a clamp highlighted with a box on the illustration.

12. Installation

Power wiring Diagram

Connection of the power cable (1 phase 2 wires)

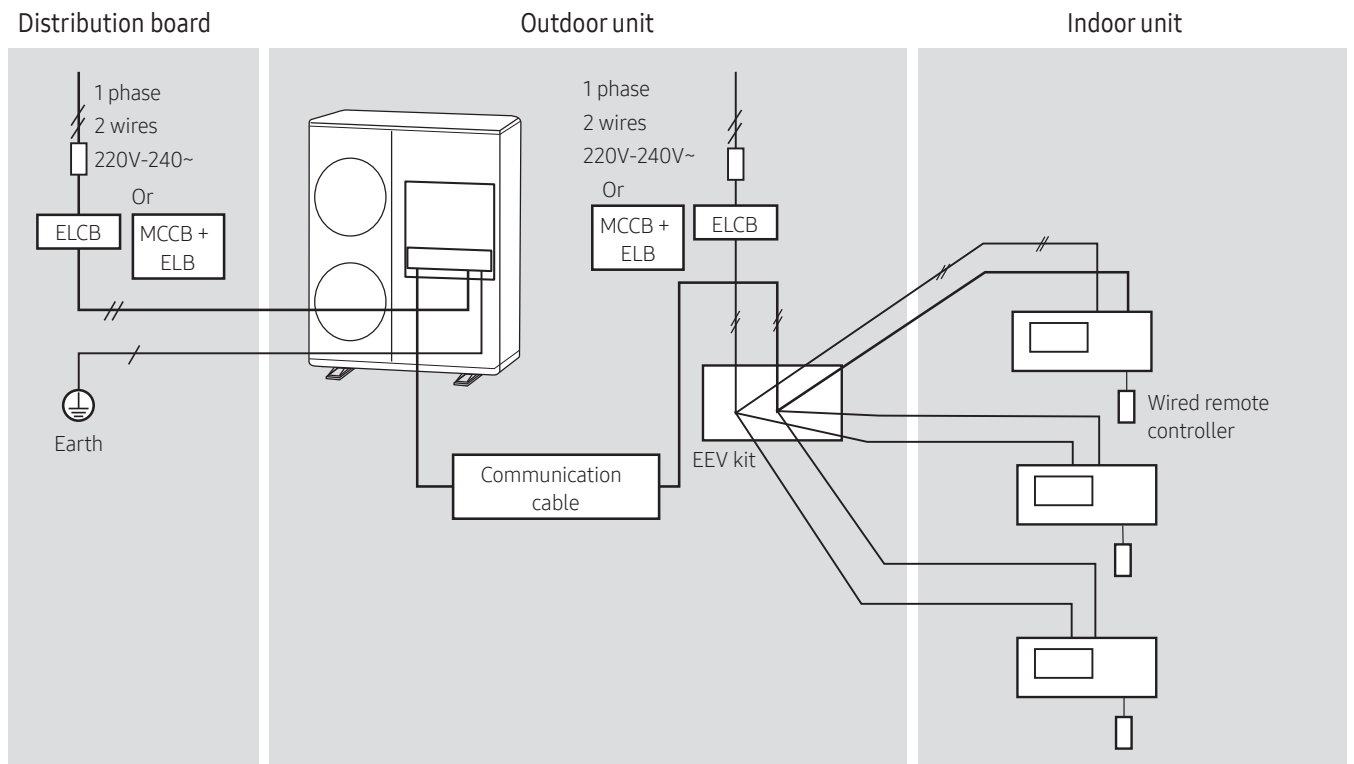
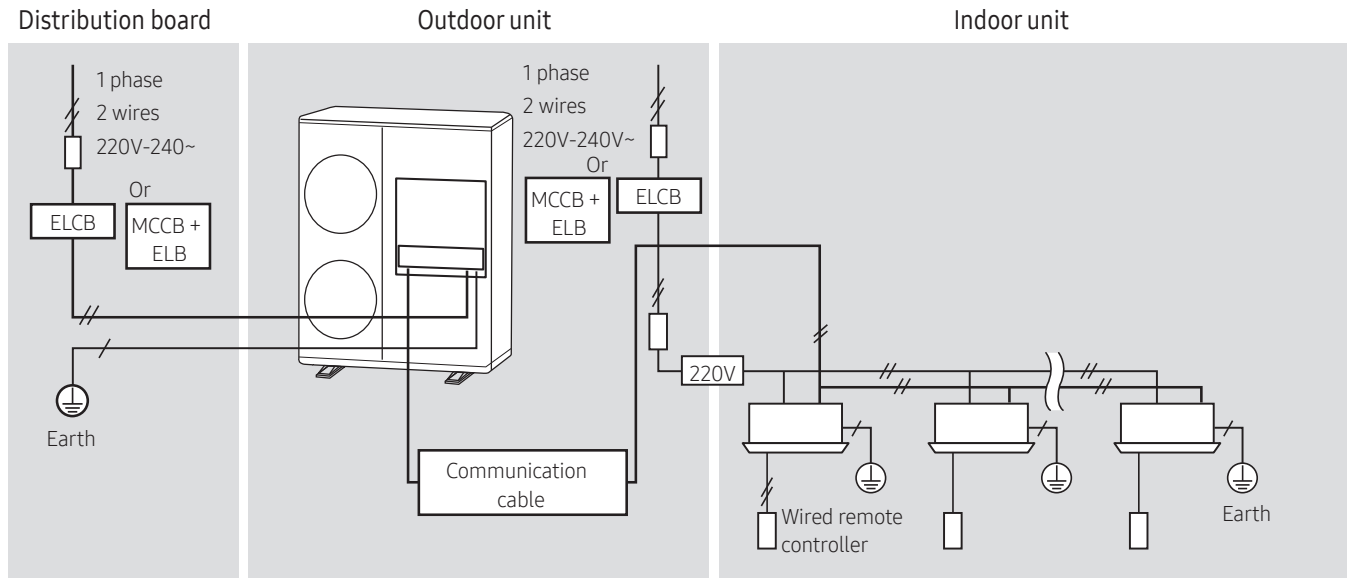

12. Installation

Connection of the power cable (3 phase 4 wires)

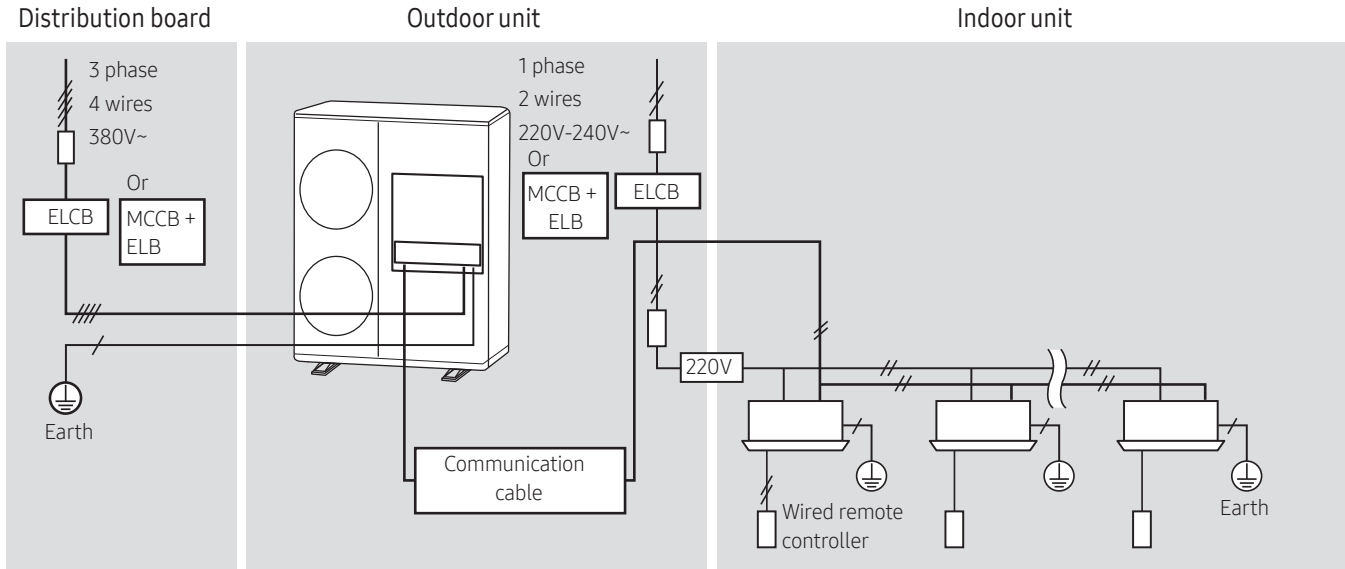

Connection of the power cable (3 phase 4 wires using EEV kit)

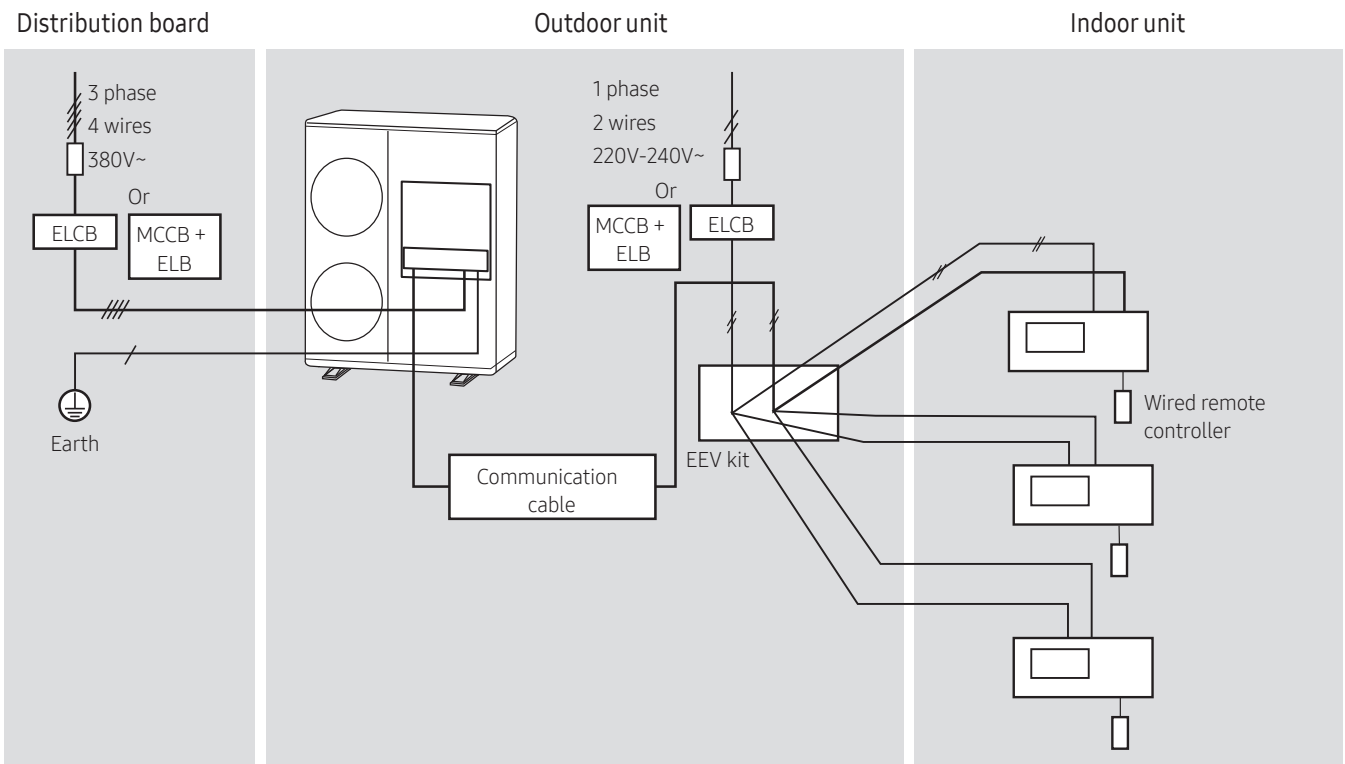

- ▶ Connect a power cable of the outdoor unit after checking that R-S-T-N (3 phase 4 wire) is properly connected. (If the 380-415 V power is supplied to the N phase, PCB and other electrical part will be damaged.)
- ▶ Communication cable between indoor and outdoor units and communication cable between outdoor units has no polarity.
- ▶ Arrange the cables with a cable tie.
- ※ ELCB and ELB must be installed since there is risk of electric shock or fire when they are not installed.

12. Installation

Space requirement for installation

- ▶ Make a space for ventilation and service as seen in the picture.
- ▶ When multiple outdoor units are combined for installation, allow enough space for ventilation against a wall. If the ventilation space is not allowed, product malfunction may occur.
- ▶ The side with logo is the front side of the outdoor unit.

✳ Figure description

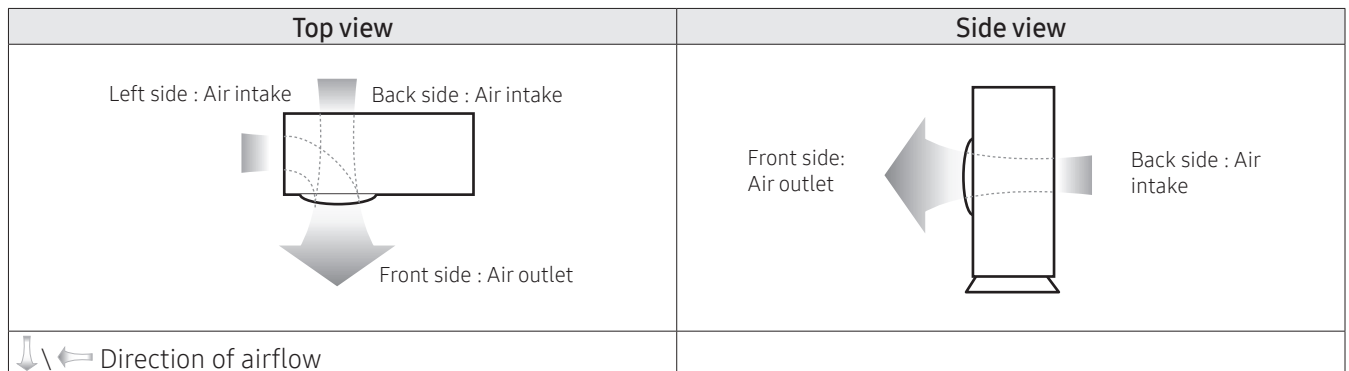

Installation location

<Instructions for parallel installation>

Unit: mm

(A) When the air inlet is blocked

✳ The upper part of the outdoor unit is not blocked

1) When installing 1 outdoor unit

- Only the air inlet is blocked

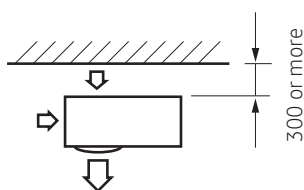

- Air inlet and 2 sides of the outdoor unit are blocked

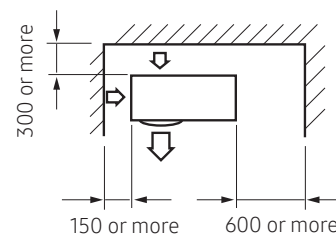

2) When parallel installing more than 2 outdoor units(*1)

- Air inlet and 2 sides of the outdoor unit are blocked

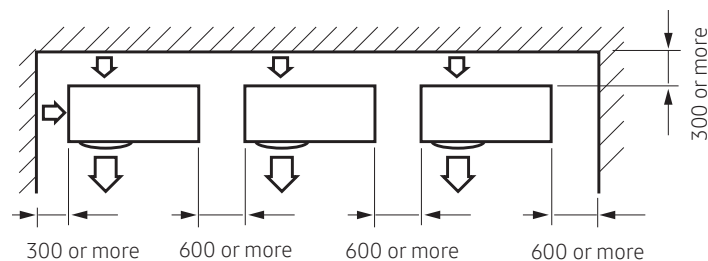

12. Installation

✖ The upper part of the outdoor unit is blocked

1) When installing 1 outdoor unit

- Only the air inlet is blocked

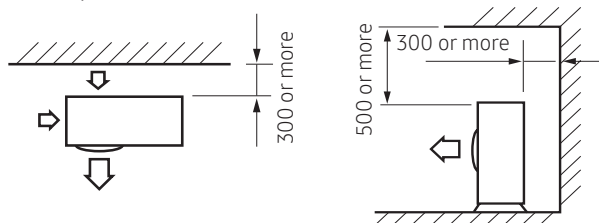

- Air inlet and 2 sides of the outdoor unit are blocked

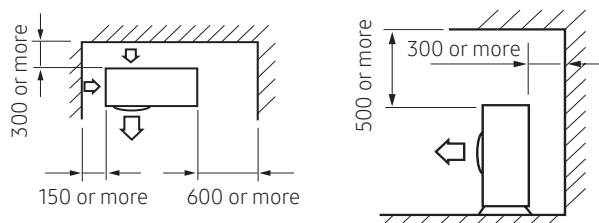

2) When parallel installing more than 2 outdoor units(*1)

- Air inlet and 2 sides of the outdoor unit are blocked

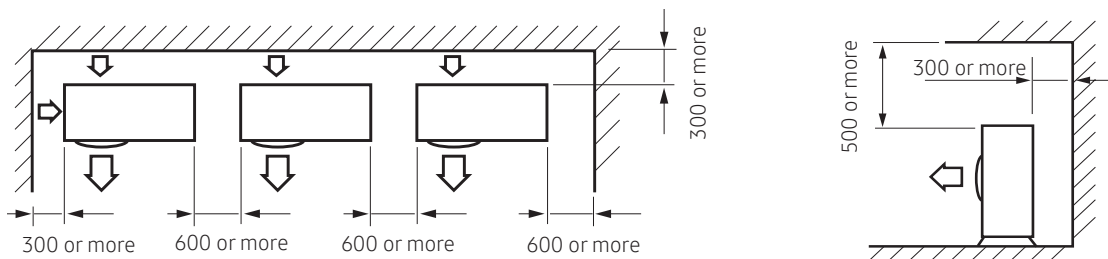

(B) When the air outlet is blocked

Unit: mm

✖ The upper part of the outdoor unit is not blocked

1) When installing 1 outdoor unit

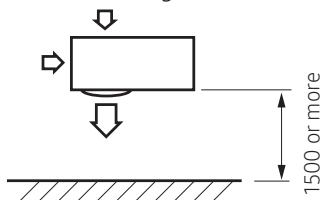

2) When parallel installing more than 2 outdoor units(*1)

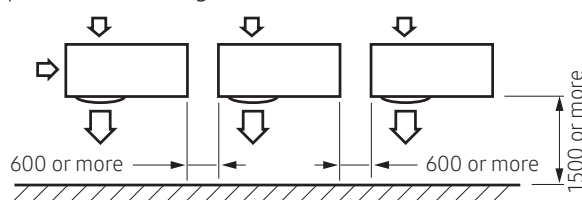

✖ The upper part of the outdoor unit is blocked

1) When installing 1 outdoor unit

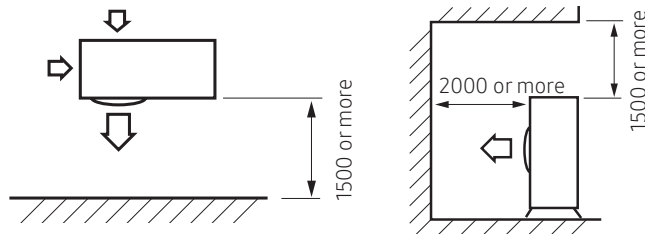

2) When parallel installing more than 2 outdoor units(*1)

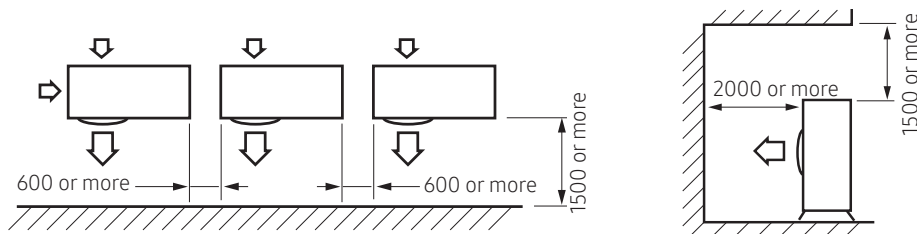

12. Installation

(C) When air inlet and air outlet of the outdoor unit are blocked

Unit: mm

Case 1: Obstacle on exhausting side is higher than the unit.(regardless of the height of obstacle on suction side)

✖ The upper part of the outdoor unit is not blocked

1) When installing 1 outdoor unit

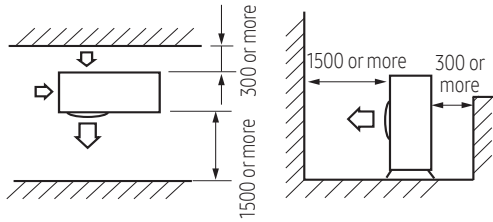

2) When parallel installing more than 2 outdoor units(*1)

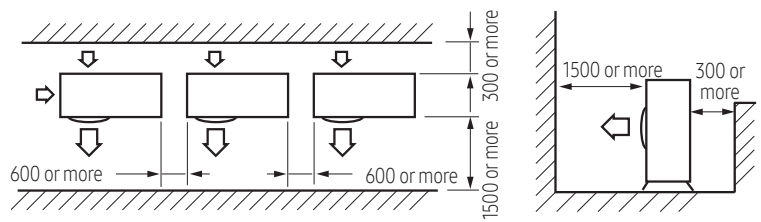

▲ The backside block can not be higher than the outdoor unit. If the backside block is higher than the outdoor unit, arrange the outdoor unit higher than the backside block.

Case 2: Obstacle on exhausting side is lower than the unit.(regardless of the height of obstacle on suction side)

✖ The upper part of the outdoor unit is not blocked

1) When installing 1 outdoor unit

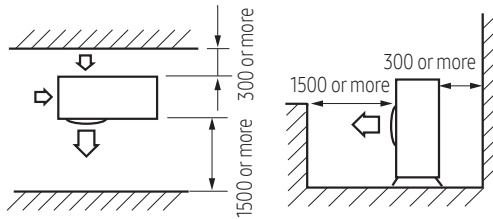

2) When parallel installing more than 2 outdoor units(*1)

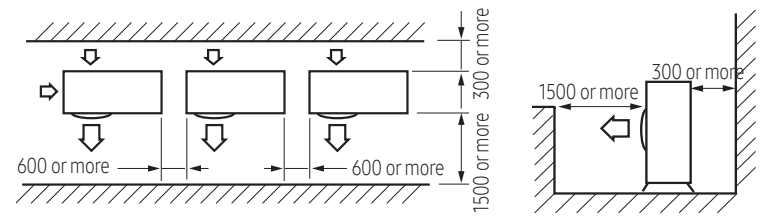

▲ The frontside block can not be higher than the outdoor unit. If the frontside block is higher than the outdoor unit, arrange the outdoor unit higher than the frontside block.

(*1) When installing outdoor units paralleled, more than 600mm gap shall be left.

When front and rear side of the outdoor unit is toward the wall

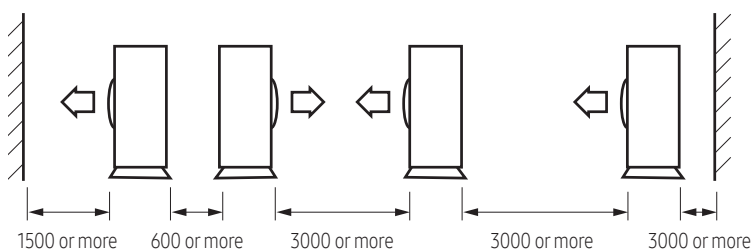

12. Installation

Base construction and installation of the outdoor unit

Base ground construction

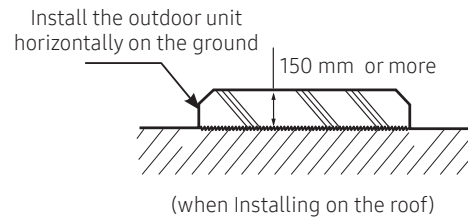
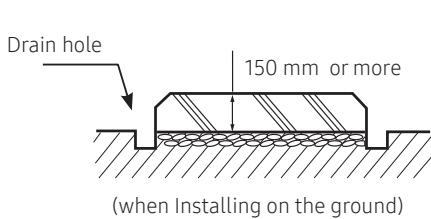

► The outdoor unit should be supported within the range of measurement below for base ground work.

Unit: mm

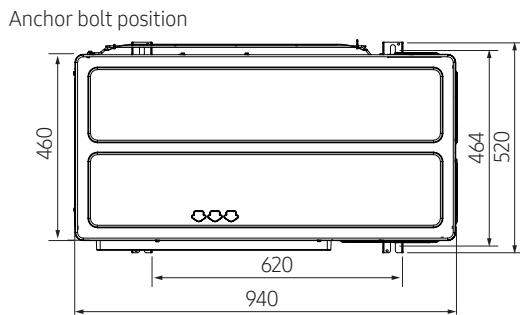

AM100/120/140KXMDGHX

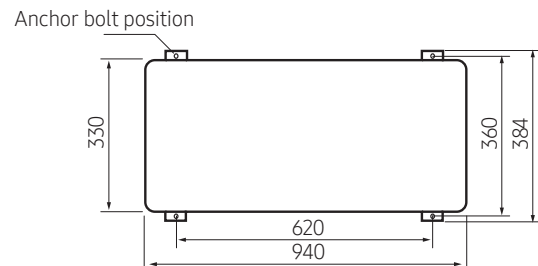

AM040/050KXMDXH*
AM040/050/060FXMDEH*
AM040/050/060FXMDGH*
AM080XMDGH*

► When the outdoor unit needs to be supported, fix it with wire as shown in the picture.

- Slightly unwind the four screws on the cover top of the outdoor unit.
- Wind wires round the four screws and fasten the screws again.
- Fix the wires to the ground.

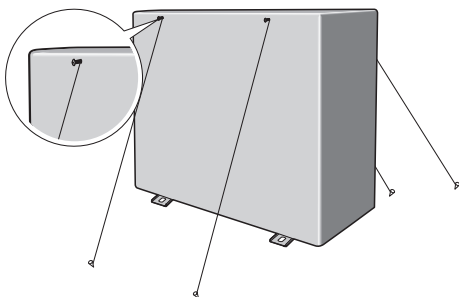

- If the outdoor unit is not fixed securely, product may fall and it might cause loss of life or property damage.
- Do not install the outdoor unit on the wooden pallet.
- Fix the outdoor unit securely to the base ground with anchor bolts.
- The manufacturer is not responsible for the damage occurred by not adhering to the standard of the installation.
- To protect the outdoor unit from external condition such as rain, install it on the base ground and connect the drain pipe to the drainage.

12. Installation



Caution

- Please firstly ensure the strength and levelness of the platform, ground and the support so as to lower the noise and vibration for fear of human injuries.
- The hanging mount on the wall is prohibited due to the heavy machine. The improper installation shall lead to the fall of the machine as well as human injuries.

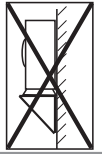

<The machine shall be installed on the ground or on the high platform>

- ▶ As shown in Figure 1, to ensure the shadow part is on the bearing surface without suspension.
- ▶ As shown in Figure 1, the four installation footings shall be firmly fastened on the base platform by the bolts (preparing four sets of M10 bolts with fitful nuts and washer which are used on site)
- ▶ In order to reduce the vibration of the noisemeter, the vibration absorber (offer on site) shall be used between the contact of machine and base platform.
- ▶ It is optimal that anchor bolt is 20mm above the surface. (See Figure 2)

The base of the outdoor unit and the position of foundation bolts

Position of the foundation bolts
(Ø12.0 Hole 4Points)

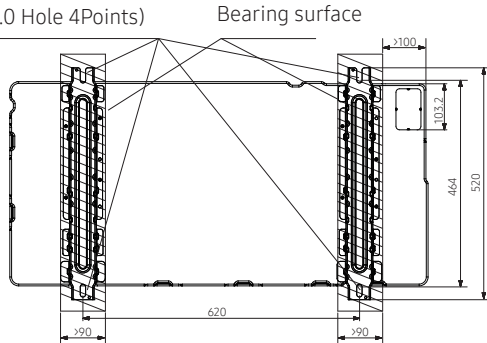

Figure 1

Unit: mm

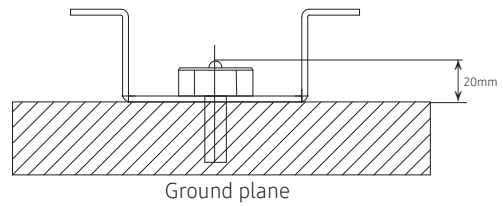
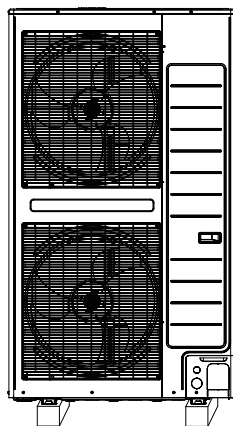
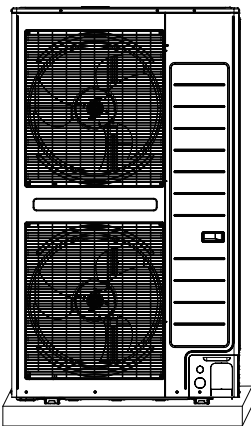

Figure 2

- ▶ Please ensure the shadow part in Figure 1 is really installed on the bearing surface without any suspension.
- ▶ The ground base that is larger than the standing leg of the air-conditioner (90mm in width and 520mm in length) shall be used to support the air-conditioner (See Figure 1), and the rubber mat shall be fully placed on the whole bearing surface.
- ▶ The base platform shall be at least 150mm above the ground.



Caution

- When the grounding pipe comes out from the below, please reserve the place for the connection pipe.
- The installation mode mentioned above shall ensure that the shadow part in Figure 1 is really on the installation surface.

12. Installation

Refrigerant pipe installation

Refrigerant pipe work

- ▶ The length of refrigerant pipe should be as short as possible and the height difference between an indoor and outdoor unit should be minimized.
- ▶ Piping work must be done within allowable piping length, height difference, and the allowable length after branching.
- ▶ The pressure of the R-410A is high. Use only certified refrigerant pipe and follow the installation method.
- ▶ After installing the pipes, calculate the total length of the pipe to check if additional refrigerant is needed. When you need to charge the additional refrigerant, make sure to use R-410A refrigerant.
- ▶ Use clean refrigerant pipe and there shouldn't be any harmful ion, oxide, dust, iron content or moisture inside pipe.
- ▶ Use tools and accessories that fit on R-410A only.

Tools	Installation process/purpose	Compatibility with conventional tool	
Pipe cutter	Refrigerant pipe installation	Pipe cutting	Compatible
Flaring tool		Pipe flaring	
Refrigerant machine oil		Apply refrigerant oil on flared part	Exclusive ether oil, ester oil, alkali benzene oil or synthetic oil
Torque wrench		Connect flare nut with pipe	Compatible
Pipe bender		Pipe bending	
Nitrogen gas	Air tightness test	Prevent oxidation within the pipe	Compatible
Welder		Pipe welding	
Manifold gage	Air tightness test ~ additional refrigerant charging	Vacuumizing, refrigerant filling as well as inspecting operation	Need exclusive one to prevent mixture of R-22 refrigerant oil use and also the measurement is not available due to high pressure
Refrigerant charging hose			Need exclusive one since there is risk of refrigerant leakage or inflow of impurities
Vacuum pump	Pipe drying	Compatible (Use products which contain the check valve to prevent the oil from flowing backward into the outdoor unit.) Use the one that can be vacuumed up to -100.7kpa(5Torr).	
Electronic scale for refrigerant filling			Compatible
Air leak tester		Gas leak test	Need exclusive one (Ones used for R-134a is compatible)
Pipeline joint	Must use the flare nut equipped with the product. Refrigerant leakage may occur when the conventional flare nut for R-22 is used.		

12. Installation

Selecting refrigerant pipe

- ▶ Install the refrigerant pipe according to main pipe size of each outdoor unit capacity.
- ▶ When the pipe length (including elbow) between an outdoor unit and the farthest indoor unit exceeds 90m, you must increase the size of the gas pipe (main pipe) by one grade which connects between the outdoor unit to the first branch joint. (The liquid pipe size will be maintained.)
- ▶ If the capacity of the outdoor unit can decline due to the pipe length, upgrade the pipe size one step (gas pipe).

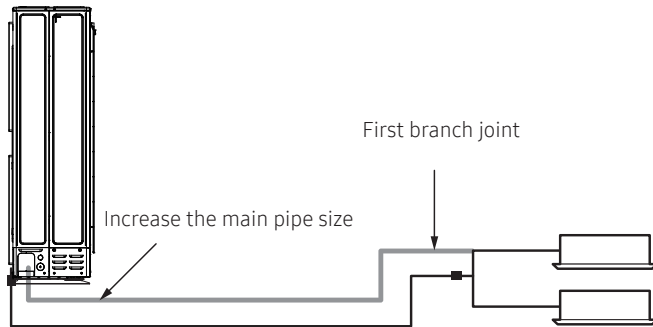

Size of the pipe between the outdoor unit and the first branch joint

Outdoor unit capacity [HP]	Liquid pipe [mm]	Gas pipe [mm]	Increased gas pipe [mm]
4	Φ9.52	Φ15.88	Φ19.05
5	Φ9.52	Φ15.88	Φ19.05
6	Φ9.52	Φ19.05	Φ22.23
8	Φ9.52	Φ19.05	Φ22.23
10	Φ9.52	Φ22.22	Φ25.40
12	Φ12.70	Φ28.58	Φ28.58
14	Φ12.70	Φ28.58	Φ28.58

Selection of branch joint

Selection of the other branch joint according to the sum of indoor unit capacity which will be connected after the branch		
Classification	Indoor unit capacity [kW]	Model name
Y-joint	15.0 kW and below	MXJ-YA1509M
	Over 15.0 kW ~ 40.0 kW and below	MXJ-YA2512M
Distribution Header	45.0 kW and Below (for 4 rooms)	MXJ-HA2512M
	70.3 kW and below (for 8 rooms)	MXJ-HA3115M

12. Installation

Size of the pipe between branch joints

Selecte the pipe size according to the sum of indoor unit capacity which will be connected after the branch.

Inddor unit capacity [kW]	Liquid pipe [mm]	Gas pipe [mm]
15.0 kW and below	Φ9.52	Φ15.88
Over 15.0 kW ~ 22.4 kW and below		Φ19.05
Over 22.4 kW		Φ22.22

12. Installation

Additional Refrigerant

- ▶ Basic amount of refrigerant within the outdoor unit (kg)
 - Amount of additional refrigerant has to be calculated based on the sum of all liquid pipe length.

Classification	AM040KXMD×H	AM050KXMD×H	AM040FXMDEH	AM050FXMDEH	AM060FXMDEH	AM040FXMDGH	AM050FXMDGH
Basic type	2.0	2.5	3.2	3.2	3.3	3.2	3.2
Classification	AM060FXMDGH	AM080FXMDGH	AM090FXMDGH	AM100KXMDGH	AM120KXMDGH	AM140KXMDGH	AM080MXMDGH
Basic type	3.3	3.7	3.7	3.7	4.3	4.8	3.7

- ▶ Charging additional refrigerant

The amount of additional refrigerant charging = The amount of refrigerant charging for pipe + the amount of refrigerant correction charging for an indoor unit

- 1) The amount of additional refrigerant depending on the pipe size.
 - Amount of additional refrigerant has to be calculated based on the sum of all liquid pipe length.

Size of liquid pipe	Φ6.35	Φ9.52	Φ12.70	Φ15.88	Φ19.05	Φ22.22	Φ25.40	Φ28.58
Additional amount (kg/m)	0.02	0.06	0.125	0.18	0.27	0.35	0.53	0.65

Additional refrigerant charging calculation = The sum of total length of Ø9.52 liquid pipe(m) x 60g + the sum of total length of Ø6.35 liquid pipe(m) x 20g

Ex) a(Ø9.52)=40m,b+c+d(Ø9.52)=15m,e+f+g(Ø6.35)=15m

The amount of additional refrigerant = 55m x 60g + 15m x 20g = 3600g

- 2) In case of using EEV kit, amount of additional refrigerant of liquid pipe between EEV kit and indoor units is 0.01kg per meter.

Amount of additional refrigerant for each indoor unit

Unit: kg

Model \ Capacity (KW)	1.5	1.7	2.2	2.8	3.6	4.5	5.6	6.0	7.1	9.0	11.2	12.8	14.0	22.0	28.0	500CMH	1000CMH
Slim 1way cassette(JSF) (AM×FN1DEH×)			0.25	0.25	0.25												
2way cassette (AM×FN2DEH×)							0.31		0.47								
Global 4way cassette (AM×FN4DEH×)						0.45	0.45		0.45	0.45	0.57	0.69	0.69				
Floor Standing Unit (AM×FNFDEH×)					0.22		0.32		0.32								
ERV plus (AM×FNKDEH×)																0.11	0.36
Global mini 4way cassette (AM×FNNDEH×)	0.29		0.29	0.29	0.29	0.37	0.37	0.37									
Slim duct (AM×FNLDEH××)		0.17	0.17	0.17	0.26	0.35	0.35		0.45	0.42	0.42	0.62	0.62				
MSP duct (AM×FNMDEH×)			0.24	0.24	0.24	0.28	0.28		0.28	0.32	0.54	0.68	0.68				
Ceiling (AM×FNCDEH×)							0.39		0.39								
Console (AM×FNJDEH×)				0.27	0.27		0.27										
Neo forte (AM×FNTDEH××)	0.24		0.24	0.24	0.24		0.36		0.36								
Neo forte(with EEV) (AM×FNQDEH××)	0.24		0.24	0.24	0.24	0.36	0.36		0.36								
HSP Duct (AM×FNLHDEH×)											0.68	0.68	0.68	1.18	1.18		
Home Duct (AM×KNLDEH)		0.13	0.13	0.13	0.17												

- ▶ If AHU kit is included among the indoor units,you must add 0.063kg of refrigerant for every 1kW of the AHU capacity increase.

12. Installation

Method to calculate total amount of additional refrigerant

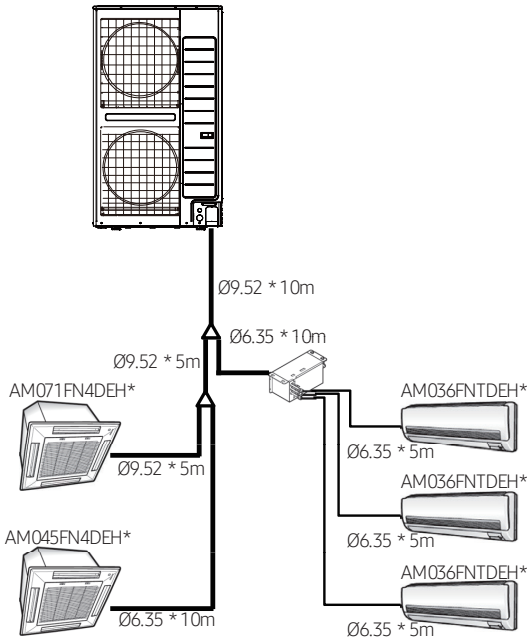

► Total amount of additional refrigerant

Total amount of additional refrigerant = Amount of additional refrigerant depending on the pipe length
+ Amount of additional refrigerant for each indoor unit

✳ Amount of additional refrigerant depending on the pipe length

Size of Liquid pipe (mm)	Length (m)	Unit amount of refrigerant (kg/m)	Amount of additional refrigerant (kg)	Total amount of additional refrigerant (kg)
Ø6.35	20	0.02	0.4	1.75
Ø9.52	20	0.06	1.2	
EEV kit ~ indoor unit	15	0.01	0.15	

Amount of additional refrigerant charging for each indoor unit

Model name of Indoor unit	Number of units (EA)	Unit amount of refrigerant (kg/m)	Amount of additional refrigerant (kg)	Total amount of additional refrigerant (kg)
AM045FN4DEH✳	1	0.45	0.45	1.62
AM071FN4DEH✳	1	0.45	0.45	
AM036FNTDEH✳	3	0.24	0.72	

► Total amount of additional refrigerant = 1.75 + 1.62 = 3.37 (kg)



When charging additional refrigerant while outdoor unit operating, you should follow below guides:

- Cooling mode : charge on the low pressure service valve.
- Heating mode : charge on the charging port. (Refer to the picture on the right.)
- Do not use the high pressure service valve as a refrigerant charge while outdoor unit operating except on vacuumizing. (High pressure refrigerant can lead to human injuries.)

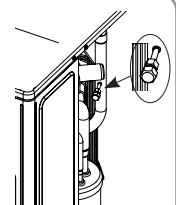

12. Installation

Keeping refrigerant pipe

To prevent foreign materials or water from entering the pipe, storing method and sealing method (especially during installation) is very important. Apply correct sealing method depending on the environment.

Exposure place	Exposure time	Sealing type
Outdoor	Longer than one month	Pipe pinch
	Shorter than one month	Taping
Indoor	-	Taping

Temper grade and minimum thickness of the refrigerant pipe

Outer diameter (mm)	Minimum thickness (mm)	Material
Ø6.35	0.7	Annealed
Ø9.52	0.7	
Ø12.70	0.8	
Ø15.88	1.0	
Ø19.05	0.9	Drawn
Ø22.22	0.9	



- For pipes larger than Ø 19.05, drawn type (C1220T-1/2H or C1220T-H) copper pipe must be used. If a annealed type (C1220T-O) copper pipe is used, pipe may break due to its low pressure resistance and cause personal injury.

12. Installation

Examples of refrigerant pipe installation

✧ Using Y-joint

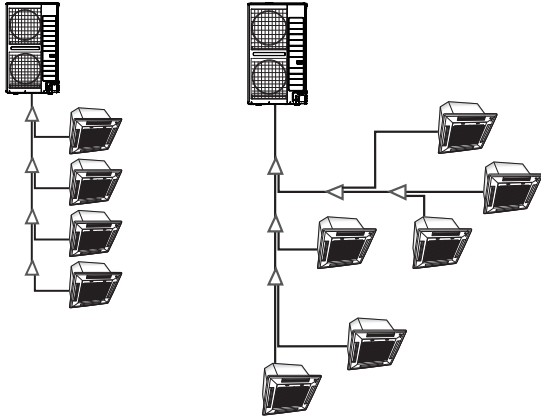

✧ Using Y-joint Using Y-joint / EEV kit

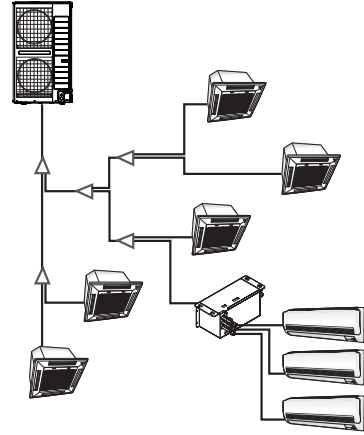

✧ Using Y-joint Using distribution header

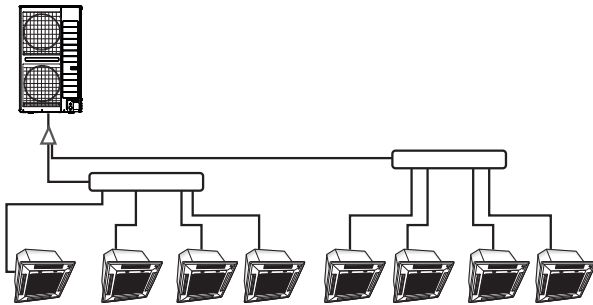

✧ Using Y-joint Using distribution header / Y-joint

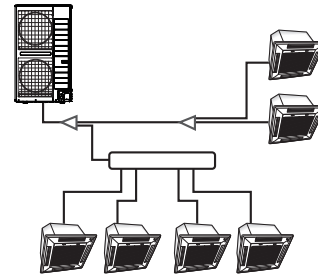

12. Installation

Allowable length of the refrigerant pipe and the installation examples

AM040/050KXMDE*

* Connection by Y-joint

Outdoor unit

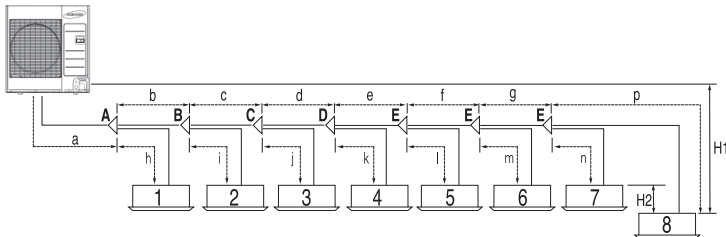

* Connection by Y-joint / EEV kit

Outdoor unit

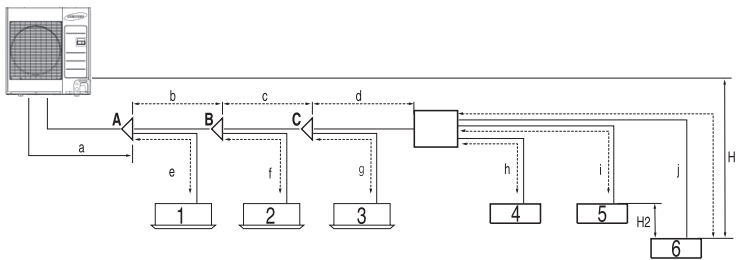

Classification		Y joint connection	Y-joint / EEV kit connection
Maximum allowable length of pipe	Outdoor unit ~ Indoor unit	Actual length	The distance between the outdoor unit and the farthest indoor unit $\leq 50\text{m}$ Ex) 8 indoor units $a+b+c+d+e+f+g+p \leq 50\text{m}$
		Equivalent length	The distance between an outdoor unit and the farthest indoor unit $\leq 65\text{m}$
		Main pipe length	The main pipe(a) from the the outdoor unit to the first Y joint $< 40\text{m}$
		Total length:	The sum of the total length of the pipes $< 150\text{m}$
Maximum allowable height	Outdoor unit ~ Indoor unit	Height	H1: Height difference between outdoor unit and indoor unit: not more than 30m when the outdoor unit is higher, or not more than 25m when the outdoor unit is lower.
		Height	H2: Height difference between indoor unit is not more than 15m.
Maximum allowable length after Y joint		Actual length	The distance between the first Y-joint and the farthest indoor unit $\leq 40\text{m}$ Ex) 8 indoor units $b+c+d+e+f+g+p \leq 40\text{m}$
			Allowable length between EEV kit and an indoor unit $\leq 20\text{m}$ Ex) : h, i, j $\leq 20\text{m}$

* When the equivalent length between an outdoor unit and the farthest indoor unit exceeds 90m, upgrade the low pressure pipe of the main pipe one step.

12. Installation

EEV kit		Model name		Remarks	
EEV kit ~ Indoor unit	Actual pipe length	2 m	MEV-E24SA	1 indoor	Apply to products without EEV (Wall mount & ceiling)
			MEV-E32SA		
		20 m or less	MXD-E24K132A	2 indoor	
			MXD-E24K200A		
			MXD-E32K200A		
			MXD-E24K232A	3 indoor	
			MXD-E24K300A		
			MXD-E32K224A		
MXD-E32K300A					

✧ Please refer to the EEV Kit manual.

Connection by distribution header

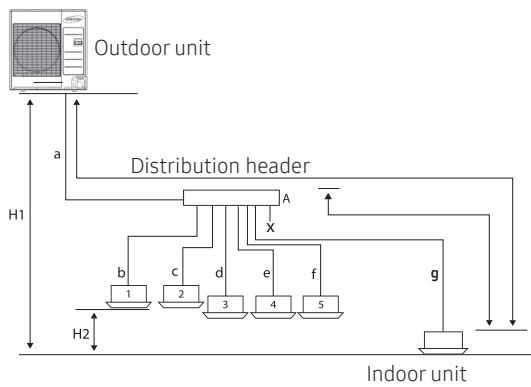

Connection by Y-joint/distribution header

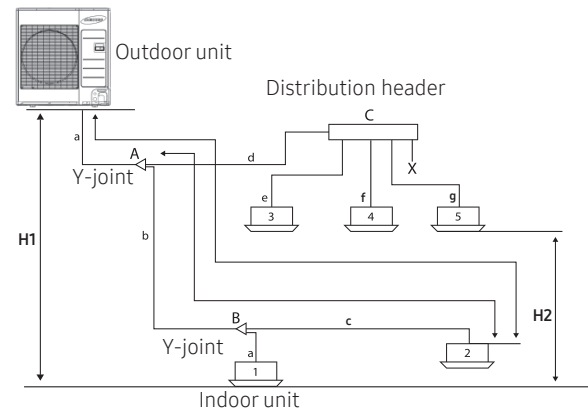

Classification		Distribution connection	Y-joint / distribution connection
Maximum allowable length of pipe	Outdoor unit ~ Indoor unit	Actual length	The distance between the outdoor unit and the farthest indoor unit $\leq 50\text{m}$ Ex) 8 indoor units $a+g \leq 50\text{m}$
		Equivalent length	The distance between outdoor unit and the farthest indoor unit $\leq 65\text{m}$
		Main pipe length	The main pipe(a) from the the outdoor unit to the first Y joint $< 40\text{m}$
		Total length:	The sum of the total length of the pipes $< 150\text{m}$
Maximum allowable height	Outdoor unit ~ Indoor unit	Height	H1: Height difference between outdoor unit and indoor unit: not more than 30m when the outdoor unit is higher, or not more than 25m when the outdoor unit is lower.
		Height	H2: Height difference between indoor unit is not more than 15m.
Maximum allowable length after Y joint	Actual length	The distance between the header joint and the indoor unit $\leq 40\text{m}$ Ex) b, c ~ f, g $\leq 40\text{m}$	The distance between the first Y joint and the farthest indoor unit $\leq 40\text{m}$ Ex) 5 indoor units $b+c, d+g \leq 40\text{m}$

✧ When the equivalent length between an outdoor unit and the farthest indoor unit exceeds 90m, upgrade the low pressure pipe of the main pipe one step.

12. Installation

AM040/050/060FXMD**

* Connection by Y-joint

Outdoor unit

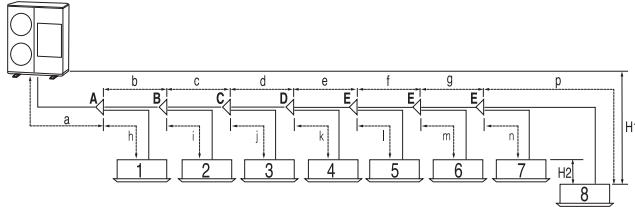

* Connection by Y-joint/EEV kit

Outdoor unit

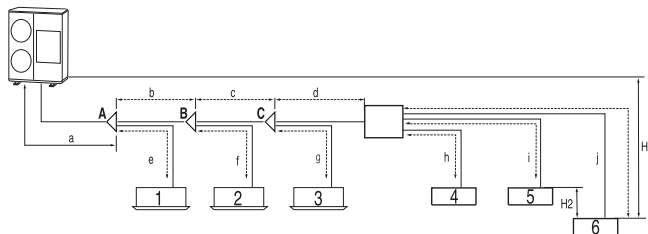

Classification		Y-joint connection	Y-joint / EEV kit connection
Maximum allowable length of pipe	Outdoor unit ~ Indoor units	Actual Length	The distance between the outdoor unit and the farthest indoor unit $\leq 150\text{m}$ Ex) 8 indoor units $a+b+c+d+e+f+g+p \leq 150\text{m}$
		Equivalent length	The distance between an outdoor unit and the farthest indoor unit $\leq 175\text{m}$
		Main pipe length	The main pipe(a) from the outdoor unit to the first Y-joint should be less than 110m.
		Total length	The sum of the total length of pipes should be less than 300m.
Maximum allowable height	Outdoor unit ~ Indoor units	Height	H1: The difference of height between an outdoor unit and indoor unit $< 50\text{m}$
		Height	H2: The difference of height between indoor units $\leq 15\text{m}$
Maximum allowable length after Y-joint		Actual Length	The distance between the first Y-joint and the farthest indoor unit $\leq 40\text{m}$ Ex) 8 indoor units $b+c+d+e+f+g+p \leq 40\text{m}$

EEV Kit		Model name		Remarks	
EEV Kit ~ Indoor units	Actual pipe length	2m or less	MEV-E24SA	1 indoor	Apply to products without EEV (Wall mounted & ceiling)
			MEV-E32SA		
		20m or less	MXD-E24K132A	2 indoor	
			MXD-E24K200A		
			MXD-E32K200A		
			MXD-E24K232A	3 indoor	
			MXD-E24K300A		
			MXD-E32K224A		
		MXD-E32K300A			

* When the equivalent length between an outdoor unit and the farthest indoor unit exceeds 90m, upgrade the low pressure pipe of the main pipe one step.

12. Installation

✧ Connection by header joint

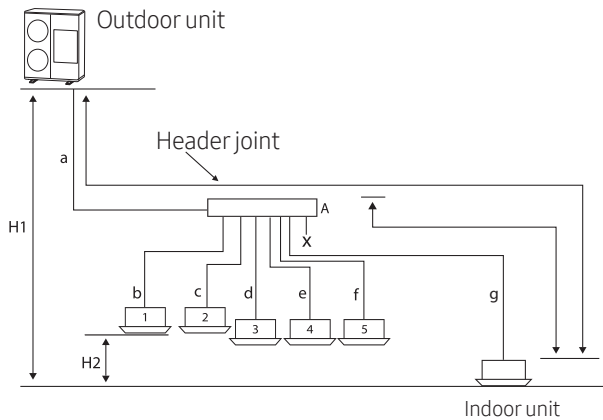

✧ Connection by Y-joint/header joint

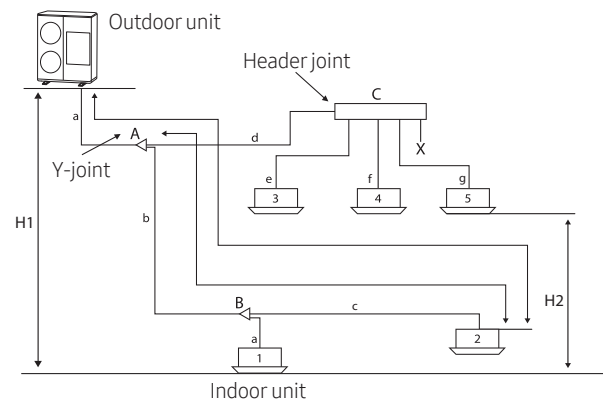

Classification		Header joint connection	Y-joint / header joint connection
Maximum allowable length of pipe	Outdoor unit ~ Indoor units	Actual Length	The distance between an outdoor unit and the farthest indoor unit $\leq 150\text{m}$ Ex) 8 indoor units $a+g \leq 150\text{m}$
		Equivalent length	The distance between an outdoor unit and the farthest indoor unit $\leq 175\text{m}$
		Main pipe length	The main pipe(a) from the outdoor unit to the first Y-joint should be less than 110m.
		Total length	The sum of total length of pipes should be less than 300m.
Maximum allowable height	Outdoor unit ~ Indoor units	Height	H1: The difference in height between an outdoor unit and indoor unit $< 50\text{m}$
		Height	H2: The difference in height between indoor units $\leq 15\text{m}$
Maximum allowable length after Y-joint		Actual Length	The distance between the header joint and the indoor unit $\leq 40\text{m}$ Ex) b, c ~ f, g $\leq 40\text{m}$
			The distance between the first Y-joint and the farthest indoor unit $\leq 40\text{m}$ Ex) 8 indoor units $b+c, d+g \leq 40\text{m}$

✧ When the equivalent length between an outdoor unit and the farthest indoor unit exceeds 90m, upgrade the low pressure pipe of the main pipe one step.

12. Installation

AM080×XMDG×

✳ Connection by Y-joint

Outdoor unit

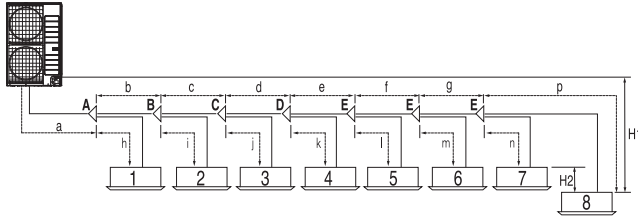

✳ Connection by Y-joint/EEV kit

Outdoor unit

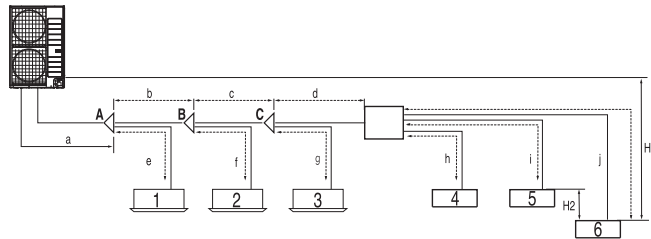

Classification		Y-joint connection	Y-joint / EEV kit connection
Maximum allowable length of pipe	Outdoor unit ~ Indoor units	Actual Length	The distance between the outdoor unit and the farthest indoor unit $\leq 100\text{m}$ Ex) 8 indoor units $a+b+c+d+e+f+g+p \leq 100\text{m}$
		Equivalent length	The distance between an outdoor unit and the farthest indoor unit $\leq 130\text{m}$
		Main pipe length	The main pipe(a) from the the outdoor unit to the first Y joint $< 80\text{m}$.
		Total length	The sum of the total length of the pipes $< 300\text{m}$.
Maximum allowable height	Outdoor unit ~ Indoor units	Height	H1: The difference of height between an outdoor unit and indoor unit $< 30\text{m}$;
		Height	H2: The difference of height between indoor units $\leq 30\text{m}$ But,when RAC EEV is installed, H2 is 15m or less.
Maximum allowable length after Y-joint		Actual Length	The distance between the first Y-joint and the farthest indoor unit $\leq 40\text{m}$; Ex) 8 indoor units $b+c+d+e+f+g+p \leq 40\text{m}$
			Allowable length between EEV kit and an indoor unit $\leq 20\text{m}$; Ex) : h, i, j $\leq 20\text{m}$

✳ When the equivalent length between an outdoor unit and the farthest indoor unit exceeds 90m, upgrade the low pressure pipe of the main pipe one step.

12. Installation

EEV Kit		Model name		Remarks	
EEV Kit ~ Indoor unit	Actual pipe length	2m	MEV-E24SA	1 indoor	Apply to products without EEV (Wall mount & ceiling)
			MEV-E32SA		
		20m or less	MXD-E24K132A	2 indoor	
			MXD-E24K200A		
			MXD-E32K200A		
			MXD-E24K232A	3 indoor	
			MXD-E24K300A		
			MXD-E32K224A		
MXD-E32K300A					

✗ Please refer to the EEV Kit manual.

Connection by distribution header

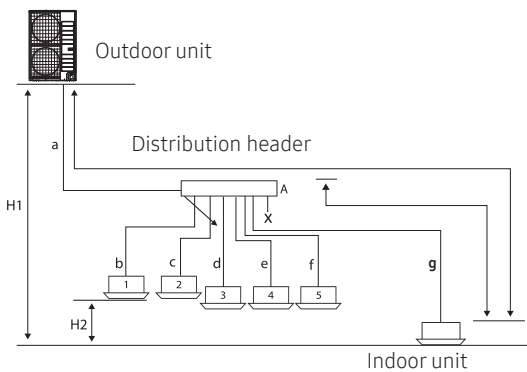

Connection by Y-joint/distribution header

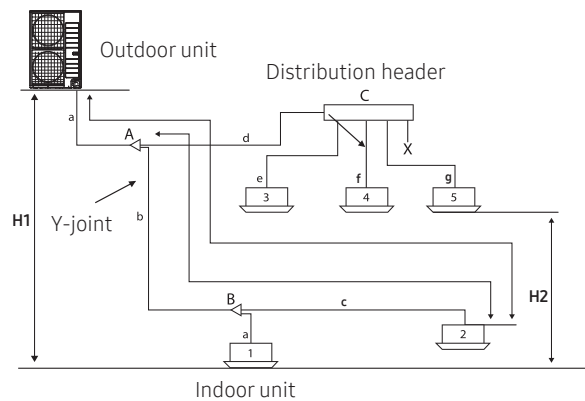

Classification		Distribution connection	Y-joint / distribution connection
Maximum allowable length of pipe	Outdoor unit ~ Indoor unit	Actual length	The distance between the outdoor unit and the farthest indoor unit $\leq 100\text{m}$
		Equivalent length	Ex) 8 indoor units $a+g \leq 100\text{m}$
		Main pipe length	Ex) 8 indoor units $a+b+c \leq 100\text{m}$
		Total length:	The distance between outdoor unit and the farthest indoor unit $\leq 130\text{m}$
Maximum allowable height	Outdoor unit ~ Indoor unit	Height	The main pipe(a) from the the outdoor unit to the first Y joint $< 80\text{m}$.
		Height	The sum of the total length of the pipes $< 300\text{m}$.
Maximum allowable length after Y joint	Actual length	Height	H1: The height difference between an outdoor unit and the indoor unit $\leq 30\text{m}$;
		Height	H2: The height difference between the indoor units $\leq 30\text{m}$
Maximum allowable length after Y joint	Actual length	Actual length	The distance between the header joint and the indoor unit $\leq 40\text{m}$ Ex) b, c ~ f, g $\leq 40\text{m}$
		Actual length	The distance between the first Y joint and the farthest indoor unit $\leq 40\text{m}$ Ex) 5 indoor units $b+c, d+g \leq 40\text{m}$

✗ When the equivalent length between an outdoor unit and the farthest indoor unit exceeds 90m, upgrade the low pressure pipe of the main pipe one step.

12. Installation

Allowable length of the refrigerant pipe and the installation examples

AM100/120/140KXMDG*

* Connection by Y-joint

Outdoor unit

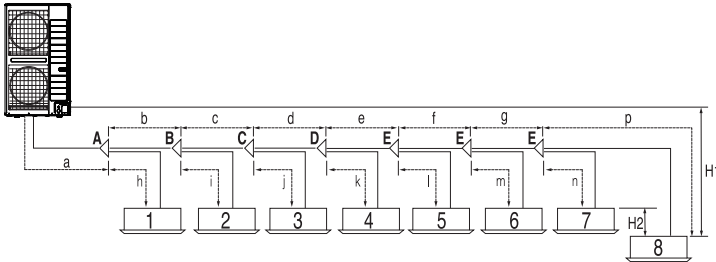

* Connection by Y-joint / EEV kit

Outdoor unit

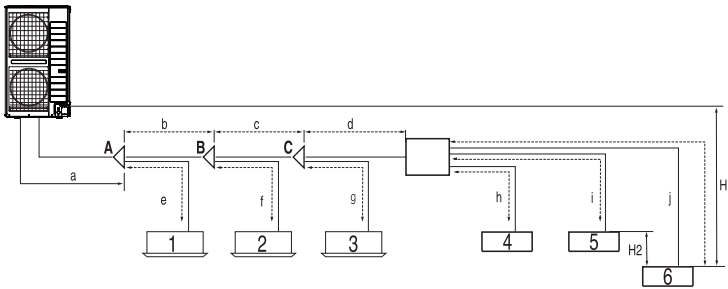

Classification		Y joint connection	Y-joint / EEV kit connection
Maximum allowable length of pipe	Outdoor unit ~ Indoor unit	Actual length	The distance between the outdoor unit and the farthest indoor unit $\leq 160\text{m}$ Ex) 8 indoor units $a+b+c+d+e+f+g+p \leq 160\text{m}$
		Equivalent length	The distance between an outdoor unit and the farthest indoor unit $\leq 185\text{m}$
		Main pipe length	The main pipe(a) from the the outdoor unit to the first Y joint $< 120\text{m}$
		Total length:	The sum of the total length of the pipes $< 300\text{m}$
Maximum allowable height	Outdoor unit ~ Indoor unit	Height	H1: The difference of height between an outdoor unit and indoor unit $< 50/40\text{m}$ ^{Note 1)}
		Height	H2: The difference of height between indoor units $\leq 50\text{m}$ But, when AM***NQE* is installed, H2 is 15 m or less.
Maximum allowable length after Y joint		Actual length	The distance between the first Y-joint and the farthest indoor unit $\leq 40\text{m}$ Ex) 8 indoor units $b+c+d+e+f+g+p \leq 40\text{m}$

* When the equivalent length between an outdoor unit and the farthest indoor unit exceeds 90m, upgrade the low pressure pipe of the main pipe one step.

* Note 1) When indoor unit is located at higher level than outdoor unit, allowable height difference is 40m, but when the indoor unit is located at lower level than outdoor unit, allowable height difference is 50m.

12. Installation

EEV kit		Model name		Remarks	
EEV kit ~ Indoor unit	Actual pipe length	2 m	MEV-E24SA	1 indoor	Apply to products without EEV (Wall mount & ceiling)
			MEV-E32SA		
		20 m or less	MXD-E24K132A	2 indoor	
			MXD-E24K200A		
			MXD-E32K200A		
			MXD-E24K232A	3 indoor	
			MXD-E24K300A		
MXD-E32K224A					
MXD-E32K300A					

* Please refer to the EEV Kit manual.

Connection by distribution header

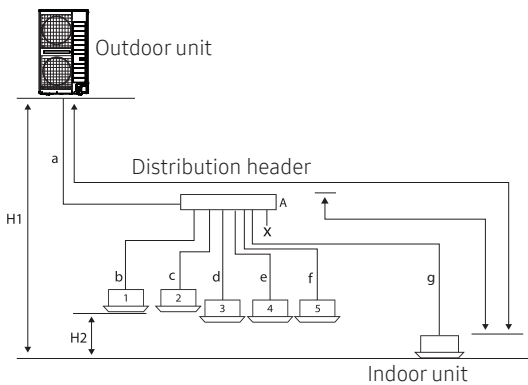

Connection by Y-joint/distribution header

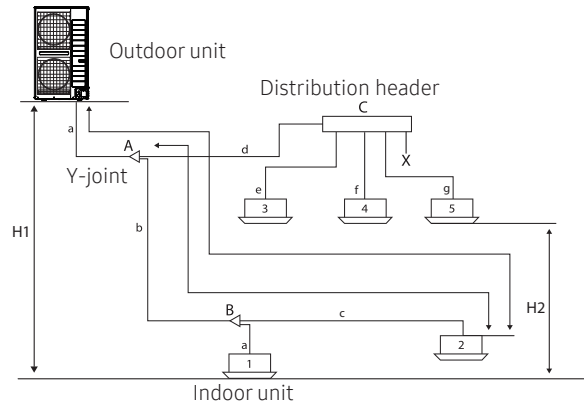

Classification		Distribution connection	Y-joint / distribution connection
Maximum allowable length of pipe	Outdoor unit ~ Indoor unit	Actual length	The distance between the outdoor unit and the farthest indoor unit $\leq 160\text{m}$ Ex) 8 indoor units $a+g \leq 160\text{m}$
		Equivalent length	The distance between outdoor unit and the farthest indoor unit $\leq 185\text{m}$
		Main pipe length	The main pipe (a) from the the outdoor unit to the first Y joint $< 120\text{m}$
		Total length:	The sum of the total length of the pipes $< 300\text{m}$
Maximum allowable height	Outdoor unit ~ Indoor unit	Height	H1: The height difference between an outdoor unit and the indoor unit $< 50/40\text{m}$ ^{Note1)}
		Height	H2: The height difference between the indoor units $\leq 50\text{m}$ But, when AMXXXNQDEHX is installed, H2 is 15 m or less.
Maximum allowable length after Y joint		Actual length	The distance between the header joint and the indoor unit $\leq 40\text{m}$ Ex) b, c ~ f, g $\leq 40\text{m}$
			The distance between the first Y joint and the farthest indoor unit $\leq 40\text{m}$ Ex) 5 indoor units $b+c, d+g \leq 40\text{m}$

* When the equivalent length between an outdoor unit and the farthest indoor unit exceeds 90m, upgrade the low pressure pipe of the main pipe one step.







* Note 1) When indoor unit is located at higher level than outdoor unit, allowable height difference is 40m, but when the indoor unit is located at lower level than outdoor unit, allowable height difference is 50m.

13. Accessory

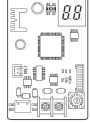
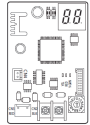

Controller

Classification	Product	Model	Image	Remark	Using
Individual Control System	Wireless Remote Controller	MR-EH00			DVM, CAC
	Wireless Remote Controller	AR-KH00E		360 CST Only	DVM, CAC
	Wired Remote Controller	MWR-WE11N			DVM, CAC
	Wired Remote Controller - Simple Type	MWR-SH00N			DVM, CAC
	Wired Remote Controller - Touch Simple Type	MWR-SH10N			DVM, CAC
	ERV Wired Remote Controller	MWR-VH12N		ERV Only	DVM, CAC
	Wired Remote Controller	MWR-WW00N		EHS Only	EHS
	Receiver KIT	MRK-A10N			DVM, CAC
	Zone Controller	MWR-ZS00N		Master controller + Damper controller	DVM, CAC
	Zone Controller	MWR-ZS10N		Slave controller	DVM, CAC
	Zone Controller	MRW-TS		External room sensor	DVM, CAC

13. Accessory

Classification	Product	Model	Image	Remark	Using
Centralized Control System	Onoff Controller	MCM-A202DN			DVM, CAC
	Touch Centralized Controller	MCM-A300N			DVM, CAC
	WIFI KIT	MIM-H03N			DVM, CAC
	Interface Module	MIM-N01			DVM, CAC
	ERV Interface Module	MIM-N10			DVM, CAC
Integrated management System	DMS2.5	MIM-D01AN			DVM, CAC
	S-NET3	MST-P3P			DVM, CAC
Gate Way	BACnet Gateway	MIM-B17BN			DVM, CAC
	Lonworks Gateway	MIM-B18BN			DVM, CAC
	External Contact Interface Module	MIM-B14			DVM, CAC
	MTFC (Multi Tenant Function Controller)	MCM-C210N			DVM
	SIM (Signal Interface Module)	MIM-B12N			DVM, CAC
	PIM (Pulse Interface Module)	MIM-B16N			DVM, CAC

13. Accessory

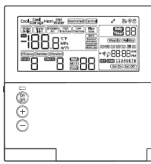
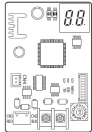
Classification	Product	Model	Image	Remark	Using
Installation /Test run Solution	S-Converter	MIM-C02N			DVM, CAC
Others	External Room Sensor	MRW-TA			DVM, CAC
	Operation Mode Selection Switch	MCM-C200			DVM
	Module Controller	MCM-A00N		CHILLER Only	CHILLER
	FCU Interface Module	MIM-F10N		CHILLER Only	CHILLER

NOTE

- In case you want more information about the accessories, please refer to the control and accessories TDB on pvi.Samsung.com site.

13. Accessory

Controller & Control Accessory Compatibility











	Item	NASA (DVM S)	Non-NASA (DVM +3/+4)	Remark
Individual Control System	Wireless Remote Controller	MR-EH00	MR-EH00	DVM, CAC
	Wireless Remote Controller	AR-KH00E	AR-KH00E	DVM, CAC (360 CST)
	Wired Remote Controller	MWR-WE11N	MWR-WE10	DVM, CAC
	Wired Remote Controller - Simple Type	MWR-SH00N	MWR-SH00	DVM, CAC
	Wired Remote Controller - Touch Simple Type	MWR-SH10N	-	DVM, CAC
	ERV Wired Remote Controller	MWR-VH12N	-	DVM, CAC (ERV)
	Wired Remote Controller	MWR-WW00N	MWR-WW00	EHS
	Receiver KIT	MRK-A10N	-	DVM, CAC
	Zone Controller	MWR-ZS00N	MWR-ZS00	DVM, CAC
	Zone Controller	MWR-ZS10N	MWR-ZS10	DVM, CAC
	Zone Controller	MRW-TS	MRW-TS	DVM, CAC
Centralized Control System	Onoff Controller	MCM-A202DN	MCM-A202D	DVM, CAC
	Touch Centralized Controller	MCM-A300N	-	DVM, CAC
	WIFI KIT	MIM-H03N	MIM-H03	DVM, CAC
	Interface Module	MIM-N01	MIM-N01	DVM, CAC
	ERV Interface Module	MIM-N10	MIM-N10	DVM, CAC
Integrated management System	DMS2.5	MIM-D01AN	MIM-D00A	DVM, CAC
	S-NET3	MST-P3P	MST-P3P	DVM, CAC
Gate Way	BACnet Gateway	MIM-B17BN	MIM-B17	DVM, CAC
	Lonworks Gateway	MIM-B18BN	MIM-B18	DVM, CAC
	External Contact Interface Module	MIM-B14	MIM-B14	DVM, CAC
	MTFC (Multi Tenant Function Controller)	MCM-C210N	-	
	SIM (Signal Interface Module)	MIM-B12N	MIM-B12	DVM, CAC
	PIM (Pulse Interface Module)	MIM-B16N	MIM-B16	DVM, CAC
	Module Controller	MCM-A00N	-	CHILLER ONLY
	FCU KIT	MIM-F00N	-	CHILLER ONLY
Installation / Test run Solution	FCU Interface Module	MIM-F10N	-	CHILLER ONLY
	S-Converter	MIM-C02N	MIM-C02	DVM, CAC
Others	External Room Sensor	MRW-TA	MRW-TA	DVM, CAC
	Operation Mode Selection Switch	MCM-C200	MCM-C200	DVM

NOTE

- In case you want to know more information the accessories, please refer to the control and accessories TDB on pvi.samsung.com site

13. Accessory

Piping

Product	Image	Model	Remark
Y-Joint		MXJ-YA1509M	15.0 kW and below
		MXJ-YA2512M	Over 15.0 kW ~ 40.0 kW and below
		MXJ-YA2812M	Over 40.0 kW ~ 45.0 kW and below
		MXJ-YA2815M	Over 45.0 kW ~ 70.3 kW and below
		MXJ-YA3419M	Over 70.3 kW ~ 98.4 kW and below
		MXJ-YA4119M	Over 98.4 kW ~ 135.2 kW and below
		MXJ-YA4422M	Over 135.2 kW
Y-Joint (Only H/R)		MXJ-YA1500M	22.4 kW and below
		MXJ-YA2500M	Over 22.4 kW ~ 70.3 kW and below
		MXJ-YA3100M	Over 70.3 kW ~ 135.2 kW and below
		MXJ-YA3800M	Over 135.2 kW
Y-Joint Outdoor Unit		MXJ-TA3419M	135.2 kW and below
		MXJ-TA4122M	140.2 kW and Over
Y-Joint (Only H/R) Outdoor Unit		MXJ-TA3100M	135.2 kW and below
		MXJ-TA3800M	140.2 kW and Over
Distribution Header		MXJ-HA2512M	45.0 kW and below (for 4 rooms)
		MXJ-HA3115M	70.3 kW and below (for 8 rooms)
		MXJ-HA3819M	Over 70.3 kW ~ 135.2 kW and below (for 8 rooms)
MCU		MCU-S6NEK2N	6 ports, max 61.6kW (~16kW/1port)
		MCU-S4NEK3N	4 ports, max 61.6kW (~16kW/1port)
		MCU-S2NEK2N	2 ports, max 32.0kW (~16kW/1port)
		MCU-S1NEK1N	1 port, max 16.0kW (~16kW/1port)
EEV KIT		MEV-E24SA	1 Indoor
		MEV-E32SA	
		MXD-E24K132A	2 Indoor
		MXD-E24K200A	
		MXD-E32K200A	
		MXD-E24K232A	3 Indoor
		MXD-E24K300A	
MXD-E32K224A			
PDM KIT		MXD-A38K2A	8~12 HP
		MXD-A12K2A	14~16 HP
		MXD-A58K2A	18~26 HP

NOTE

- In case you want more information about the accessories, please refer to the control and accessories TDB on pvi.Samsung.com site.

13. Accessory

Indoor

Product	Image	Model	Remark
Panel		PC1NUSMAN	1Way CST (JSF-1)
		PC1NUPMAN	1Way CST (JSF-1) (Z-sliding)
		PC1MWSKAN	1Way CST (JSF-0)
		PC1NWSMAN	1Way CST (JSF-1)
		PC1BWSMAN	1Way CST (JSF-2)
		PC2NUSMEN	2Way Cassette
		PC4SUSMAN	4Way Cassette S (600x600) (Waffle)
		PC4SUSMEN	4Way Cassette S (600x600) (Classic)
		PC4NUSKAN	4way Cassette S (Waffle)
		PC4NUSKEN	4way Cassette S (Classic)
		PC4NBSKAN	4way Cassette S (Waffle, Black)
		PC4NUDMAN	360 CST Square (White)
		PC4NUNMAN	360 CST Circular (White)
		PC4NBDMAN	360 CST Square (Black)
		PC4NBNMAN	360 CST Circular (Black)
S-Plasma Ion KIT		MSD-CAN1	[Option] 1Way, 4Way, 4Way (600x600), 360, Big Ceiling [Include] Console
		MSD-EAN1	[Option] Duct S, Big Duct, ERV, ERV Plus

13. Accessory

Product	Image	Model	Remark			
Motion detect Sensor		MCR-SMA	4Way Cassette S (600x600)			
ERV CO2 Sensor		MOS-C1	ERV, ERV PLUS			
External room sensor		MRW-TA	Cassette, Wall-mount, Ceiling, Duct, Console			
Drain Pump		MDP-N047SNC0D	OAP Duct (14.0 kW)			
		MDP-N047SNC1D	HSP Duct (22.0 / 28.0 kW) OAP Duct (22.4 / 28.0 kW)			
		MDP-M075SGU1D	MSP-0 / 1 Duct (9.2 / 11.2 kW)			
		MDP-M075SGU2D	MSP-2 Duct (12.8 / 14.0 kW) HSP Duct (11.2 / 12.8 / 14.0 kW)			
		MDP-M075SGU3D	MSP-S Duct (5.6 / 7.1 kW)			
		MDP-E075SEE3D	Slim Duct (2.0~14.0 kW)			
		MDP-G075SP	Duct S (External, All Capacities) BIG Duct			
		MDP-G075SQ	Duct S (Internal, 3.5 kW~14 kW) BIG Duct			
AHU KIT		MXD-K025AN	7.0 kW~8.75 kW			
		MXD-K050AN	14.0 kW~17.5 kW			
		MXD-K075AN	21.0 kW~26.25 kW			
		MXD-K100AN	28.0 kW~35.0 kW			
		MCM-D201N	28kW~35kW	56kW~70kW	84kW~105kW	112kW~140kW
		MDX-A64K100E X1 EA	MDX-A64K100E X2 EA	MDX-A64K100E X3 EA	MDX-A64K100E X4 EA	

NOTE

- In case you want more information about the accessories, please refer to the control and accessories TDB on pvi.Samsung.com site.

13. Accessory

Indoor unit's Accessory Compatibility

Product	Model	Remark	1way			2way	4way	360	4W (600x600)	Slim duct	MSP Duct				Duct-S	Big Duct	HSP Duct	OAP Duct		RAC	Ceiling	B-Ceiling	Console	PAC	Floor-Standing	ERV Plus	AHU	
			JSF-0	JSF-1	JSF-2						5HP	8,10HP																
Panel	PC4NUDMAN	Ceiling						0																				
	PC4NBDMAN	Ceiling (Black)						0																				
	PC4NUNMAN	Open						0																				
	PC4NBNMAN	Open (Black)						0																				
	PC4NUSKAN	Waffle						0																				
	PC4NBSKAN	Waffle (Black)						0																				
	PC4NUSKEN	Classic						0																				
	PC4SUSMAN	Waffle						0																				
	PC4SUSMEN	Classic						0																				
	PC1NUSMAN	Stripe		0																								
	PC1NUPMAN	Z-Slide		0																								
	PC1MWSKAN	Fluid		0																								
	PC1NWSMAN			0																								
PC1BWSMAN				0																								
PC2NUSMEN	Stripe				0																							
DRAIN PUMP	MDP-N047SNC0D	-															0											
	MDP-N047SNC1D	-														0		0										
	MDP-M075SGU1D	-										0	0															
	MDP-M075SGU2D	-											0															
	MDP-M075SGU3D	-									0																	
	MDP-E075SEE3D	-								0																		
	MDP-G075SP	External, All Capacities														0	0											
	MDP-G075SQ	Internal														0	0											
S-Plasma Ion KIT	MSD-CAN1	-						0	0																			
	MSD-EAN1	-																								0		
Motion detect Sensor	MCR-SMA	-						0																				
ERV CO2 Sensor	MOS-C1	-																								0		
EEV KITS	MEV-E**SA	1 Indoor																	0									
	MXD-E**K***A	2,3 Indoor																	0									
MCU-KIT	MCU-S6NEK2N	6 ports, max 61.6kW	0	0	0	0	0	0	0	0	0	0	0	0	0	0	0			0	0	0	0	0	0	0	0	
	MCU-S4NEK3N	4 ports, max 61.6kW	0	0	0	0	0	0	0	0	0	0	0	0	0	0	0			0	0	0	0	0	0	0	0	
	MCU-S2NEK2N	2 ports, max 32.0kW	0	0	0	0	0	0	0	0	0	0	0	0	0	0	0			0	0	0	0	0	0	0	0	
	MCU-S1NEK1N	1 port, max 16.0kW	0	0	0	0	0	0	0	0	0	0	0	0	0	0	0			0	0	0	0	0	0	0	0	
AHU-KIT	MXD-K025AN	only for 2.5Hp's AHU																									0	
	MXD-K050AN	only for 5Hp's AHU																									0	
	MXD-K075AN	only for 7.5Hp's AHU																									0	
	MXD-K100AN	only for 10Hp's AHU																									0	
	MCM-D201N	only for 10~40Hp's AHU																									0	

NOTE

- In case you want to know more information the accessories, please refer to the control and accessories TDB on pvi.samsung.com site

2019. 03
Ver.3.5

Samsung Electronics Co., LTD.

Head Office (Suwon Korea) 129, Samsung-Ro, Yeongtong-Gu, Suwon City, Gyeonggi-Do, Korea 16677
Website : www.samsung.com, <https://partnerhub.samsung.com> Email : airconditioner@samsung.com
Images and data in this book may subject to change without prior notice.