

Service Manual

Iflex IV i VRF



575IVQ007H9016

575IVQ008H9016

575IVQ009H9016

575IVQ010H9016

575IVQ012H9016

CONTENTS

Part 1 General Information.....	3
Part 2 Component Layout and Refrigerant Circuits	9
Part 3 Control	17
Part 4 Field Settings.....	29
Part 5 Electrical Components and Wiring Diagrams	35
Part 6 Diagnosis and Troubleshooting.....	49

Part 1

General Information

1	Indoor and Outdoor Unit Capacities	4
2	External Appearance	5
3	Combination Ratio.....	7

1 Indoor and Outdoor Unit Capacities

1.1 Indoor Units

1.1.1 VRF indoor units

Table 1-1.1: Indoor unit abbreviation codes

Abbreviation code	Type
FN4DU	High Static Pressure Duct
619HW	Wall-mounted
638AA	Ceiling & Floor
619CA	Four-way Cassette
FJ4DU	Medium Static Pressure Duct

Table 1-1.2: Indoor unit capacity range

Capacity			Capacity index	619CA	FJ4DU	FN4DU	619HW	638AA
kW	kBtu/h	HP						
1.8	5	0.6	18	—	—	—	—	—
2.2	7	0.8	22	—	22	—	22	—
2.8	9	1	28	28	28	—	28	—
3.6	12	1.25	36	36	36	—	36	36
4.5	15	1.6	45	45	45	—	45	45
5.6	19	2	56	56	56	—	56	56
7.1	24	2.5	71	71	71	71	71	71
8.0	27	3	80	80	80	80	80	80
9.0	30	3.2	90	90	90	90	90	90
10.0	34	3.6	100	100	—	—	—	—
11.2	38	4	112	112	112	112	—	112
14.0	48	5	140	140	140	140	—	140
16.0	55	6	160	—	—	160	—	-
20.0	68	7	200	—	—	200	—	—
25.0	85	9	250	—	—	250	—	—
28.0	96	10	280	—	—	280	—	—
40.0	136	14	400	—	—	-	—	—
45.0	154	16	450	—	—	-	—	—
56.0	191	20	560	—	—	-	—	—

1.2 Outdoor Units

Table 1-1.5: Outdoor unit capacity range

Capacity	Model Name
7HP	575IVQ007H9016
8HP	575IVQ008H9016
9HP	575IVQ009H9016
10HP	575IVQ010H9016
12HP	575IVQ012H9016

Notes:

1. Iflex IV i series outdoor units could not be combined.

2 External Appearance

2.1 Indoor Units

2.1.1 VRF indoor units

Table 1-2.1: Indoor unit appearance

Four-way Cassette 619CA			
Medium Static Pressure Duct FJ4DU		High Static Pressure Duct FN4DU	
Wall-mounted 619HW		Ceiling & Floor 638AA	

2.2 Outdoor Units

Table 1-2.4: Outdoor unit appearance



3 Combination Ratio

$$\text{Combination ratio} = \frac{\text{Sum of capacity indexes of the indoor units}}{\text{Capacity index of the outdoor unit}}$$

T Table 1-3.1: Indoor and outdoor unit combination ratio limitations

Type	Minimum combination ratio	Maximum combination ratio		
		Standard indoor units only	Fresh air processing units only	Fresh air processing units and standard indoor units together
Iflex IV i Series outdoor units	50%	130%	100%	100% ¹

Notes:

1. When fresh air processing units are installed together with standard indoor units, the total capacity of the fresh air processing units must not exceed 30% of the total capacity of the outdoor units and the combination ratio must not exceed 100%.

Table 1-3.2: Combinations of Indoor and outdoor units

Outdoor unit capacity			Sum of capacity indexes of connected indoor units (standard indoor units only)	Sum of capacity indexes of connected indoor units (fresh air processing units and standard indoor units together)	Maximum number of connected indoor units
kW	HP	Capacity index			
20.0	7	200	100 to 260	100 to 200	10
22.4	8	224	112 to 291.2	126 to 224	13
26.0	9	260	130 to 338	130 to 260	15
28.0	10	280	140 to 364	140 to 280	16
33.5	12	335	167.5 to 435.5	167.5 to 335	20

Part 2

Component Layout and Refrigerant Circuits

1 Piping Diagrams	10
2 Refrigerant Flow Diagrams	13

1 Piping Diagrams

Figure 2-1.1: 7/8/9/10HP piping diagram

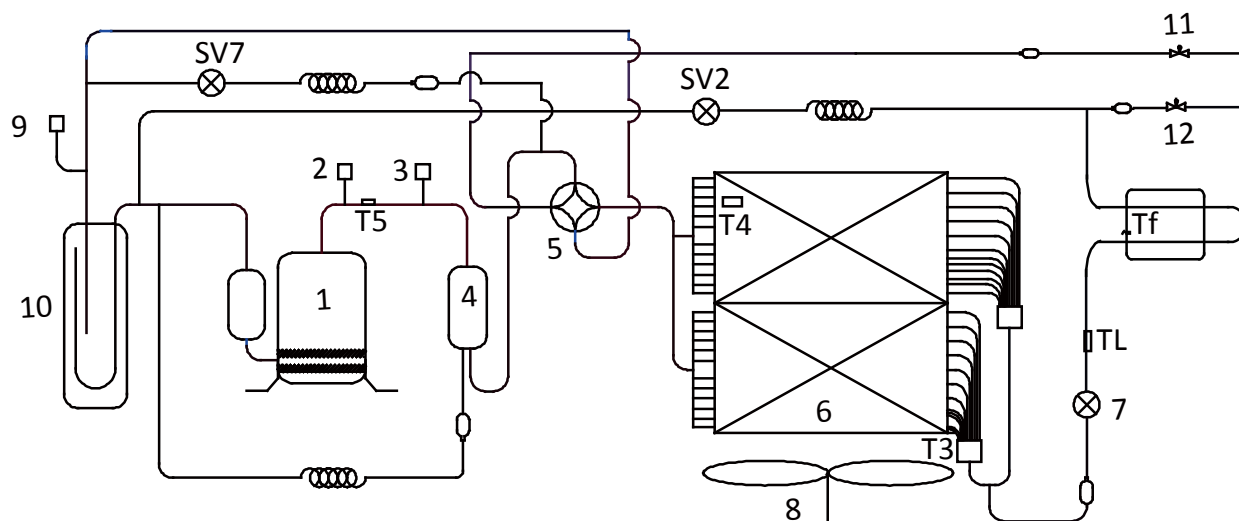

Legend			
No.	Parts name	No.	Parts name
1	Compressor	11	Stop valve (gas side)
2	High pressure switch	12	Stop valve (liquid side)
3	High pressure sensor	T3	Heat exchanger temperature sensor
4	Oil separator	T4	Outdoor ambient temperature sensor
5	Four-way valve	T5	Discharge temperature sensor
6	Heat exchanger	Tf	Heat sink temperature sensor
7	Electronic expansion valve (EXV)	TL	Refrigerant cooling pipe temperature sensor
8	Fan	SV2	Liquid injection valve
9	Low pressure switch	SV7	Refrigerant bypass valve
10	Accumulator		

Figure 2-1.2: 12HP piping diagram

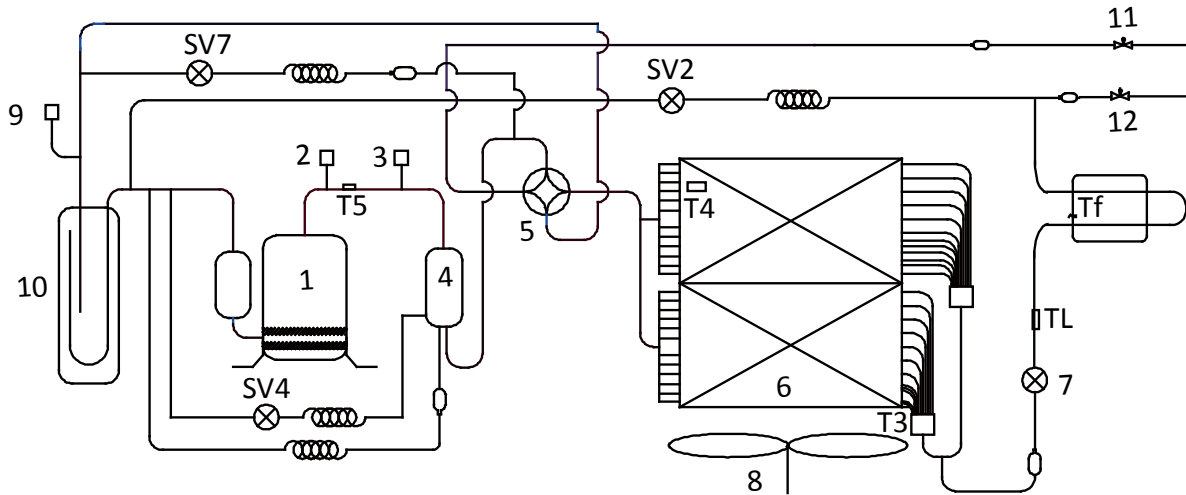

Legend			
No.	Parts name	No.	Parts name
1	Compressor	11	Stop valve (gas side)
2	High pressure switch	12	Stop valve (liquid side)
3	High pressure sensor	T3	Heat exchanger temperature sensor
4	Oil separator	T4	Outdoor ambient temperature sensor
5	Four-way valve	T5	Discharge temperature sensor
6	Heat exchanger	Tf	Heat sink temperature sensor
7	Electronic expansion valve (EXV)	TL	Refrigerant cooling pipe temperature sensor
8	Fan	SV2	Liquid injection valve
9	Low pressure switch	SV4	Oil return valve
10	Accumulator	SV7	Refrigerant bypass valve

Key components:

- 1. Oil separator:**
Separates oil from gas refrigerant pumped out of the compressor and quickly returns it to the compressor. Separation efficiency is up to 99%.
- 2. Accumulator:**
Stores liquid refrigerant and oil to protect compressor from liquid hammering.
- 3. Electronic expansion valve (EXV):**
Controls refrigerant flow and reduces refrigerant pressure.
- 4. Four-way valve:**
Controls refrigerant flow direction. Closed in cooling mode and open in heating mode. When closed, the heat exchanger functions as a condenser; when open, the heat exchanger functions as an evaporator.
- 5. Solenoid valve SV2:**
Protects the compressor. If compressor discharge temperature rises above 98°C, SV2 opens and sprays a small amount of liquid refrigerant to cool the compressor. SV2 closes again once the discharge temperature has fallen below 85°C.
- 6. Solenoid valve SV4:**
Returns oil to the compressor. Opens once the compressor has run for 200 seconds and closes 600 seconds later and then opens for 3 minutes every 20 minutes.
- 7. Solenoid valve SV7:**
Allows refrigerant return to the compressor directly. Opens when indoor air temperature is close to the set temperature to avoid frequent compressor on/off.
- 8. High and low pressure switches:**
Regulate system pressure. When system pressure rises above the upper limit or falls below the lower limit, the high or low pressure switches turn off, stopping the compressor. After 5 minutes, the compressor restarts.

2 Refrigerant Flow Diagrams

Cooling operation

Figure 2-2.1: Refrigerant flow during cooling operation

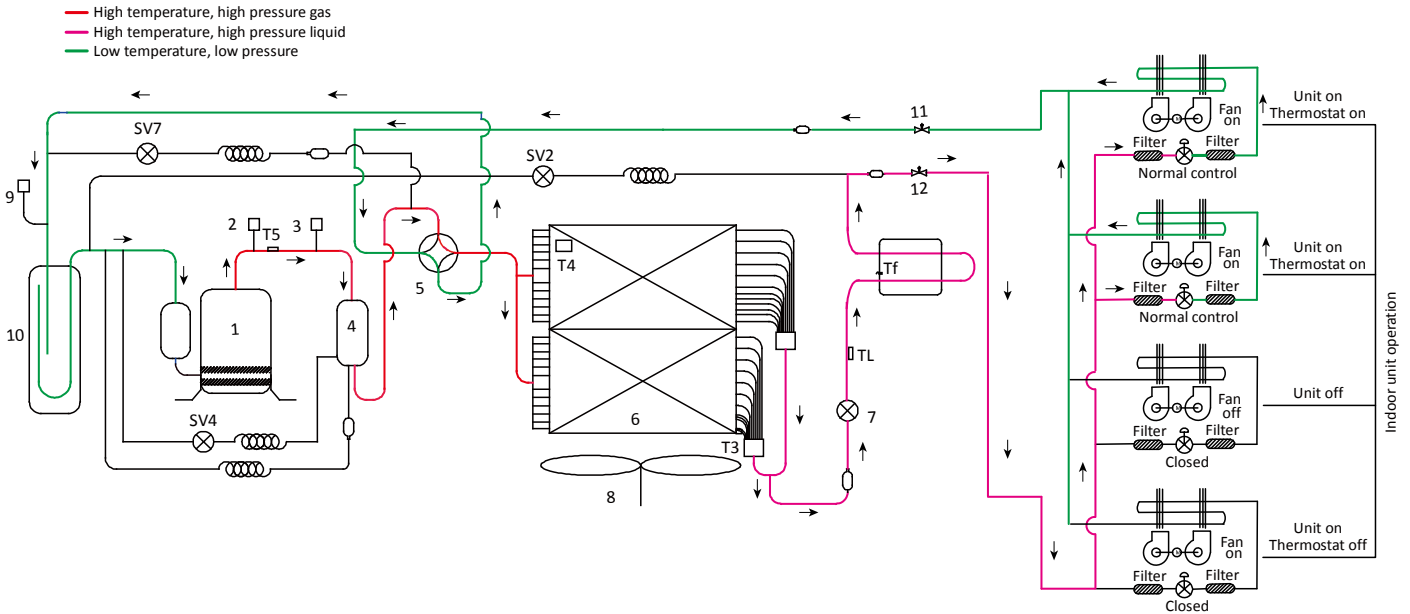

Notes:

1. 7/8/9/10HP outdoor unit doesn't have SV4.

Oil return operation in cooling mode

Figure 2-2.2: Refrigerant flow during oil return operation in cooling mode

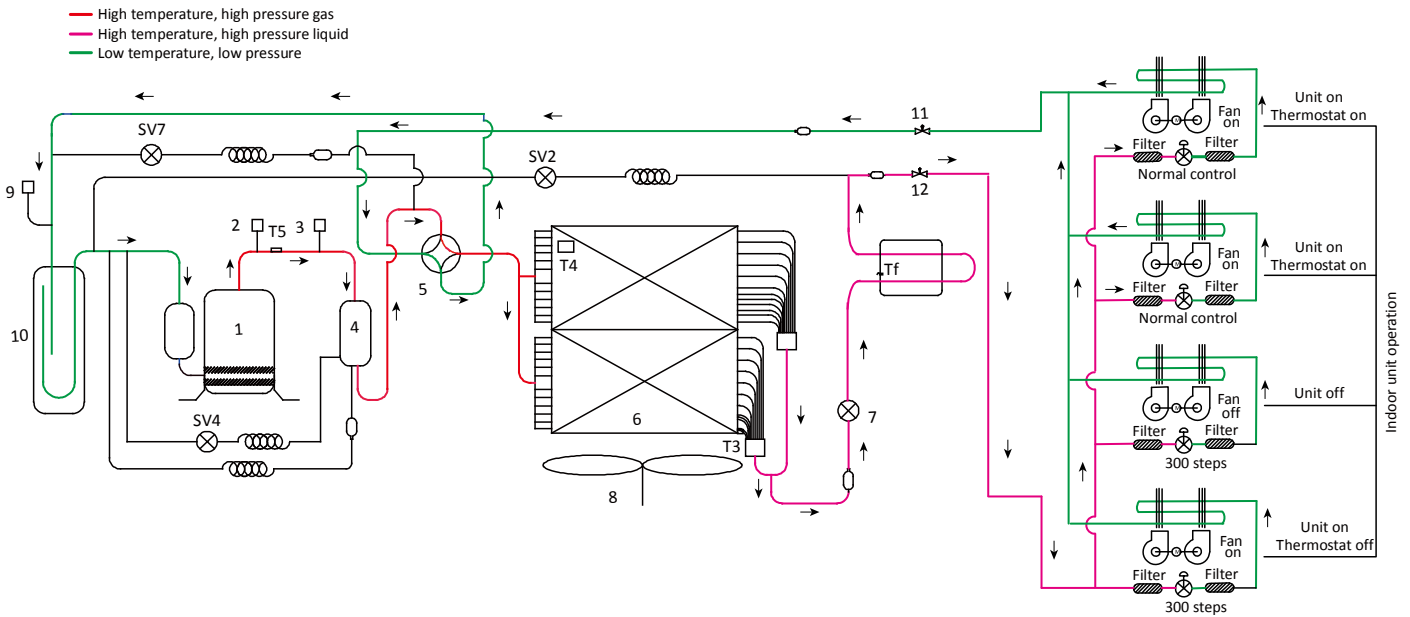

Notes:

1. 7/8/9/10HP outdoor unit doesn't have SV4.

Heating operation

Figure 2-2.3: Refrigerant flow during heating operation

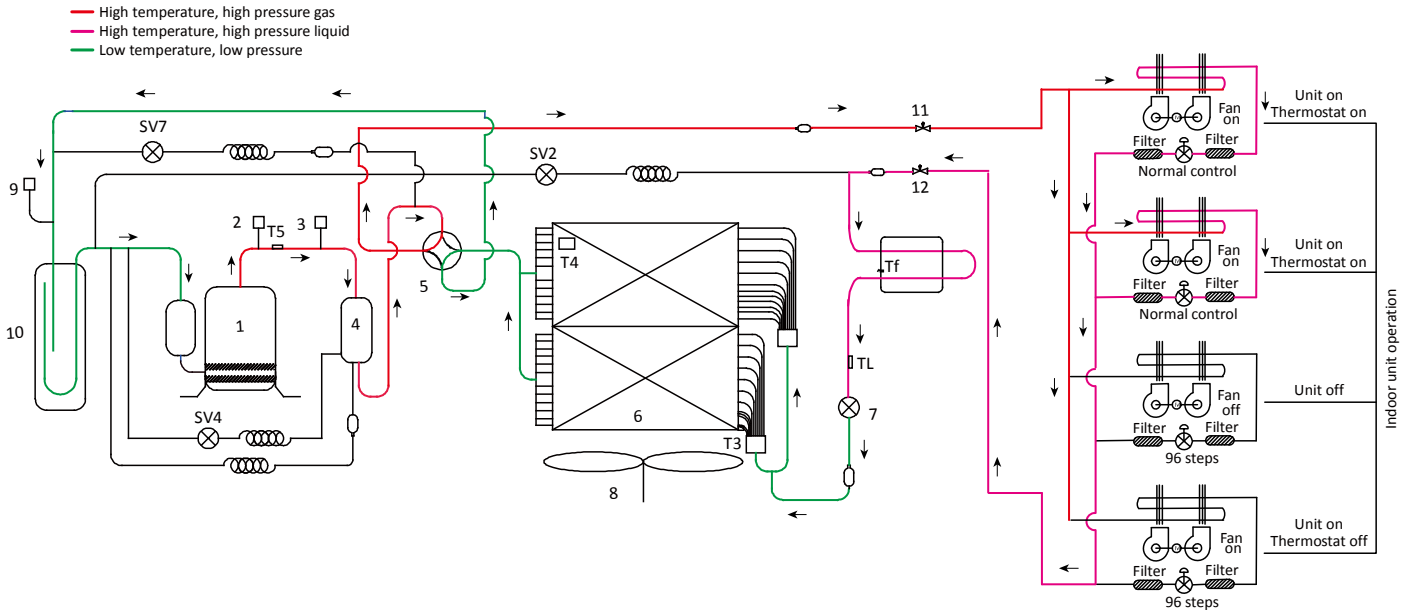

- Notes:
1. 7/8/9/10HP outdoor unit doesn't have SV4.

Oil return operation in heating mode

Figure 2-2.4: Refrigerant flow during oil return operation in heating mode

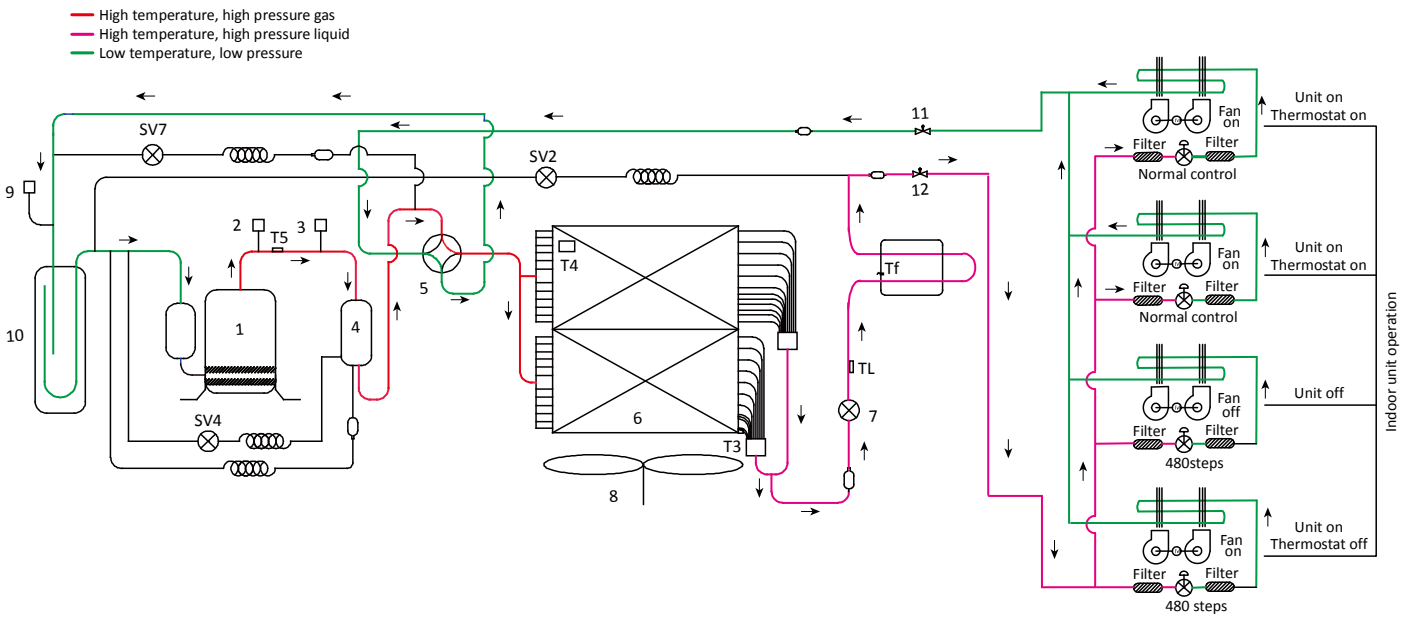

- Notes:
1. 7/8/9/10HP outdoor unit doesn't have SV4.

Defrosting operation

Figure 2-2.5: Refrigerant flow during defrosting operation

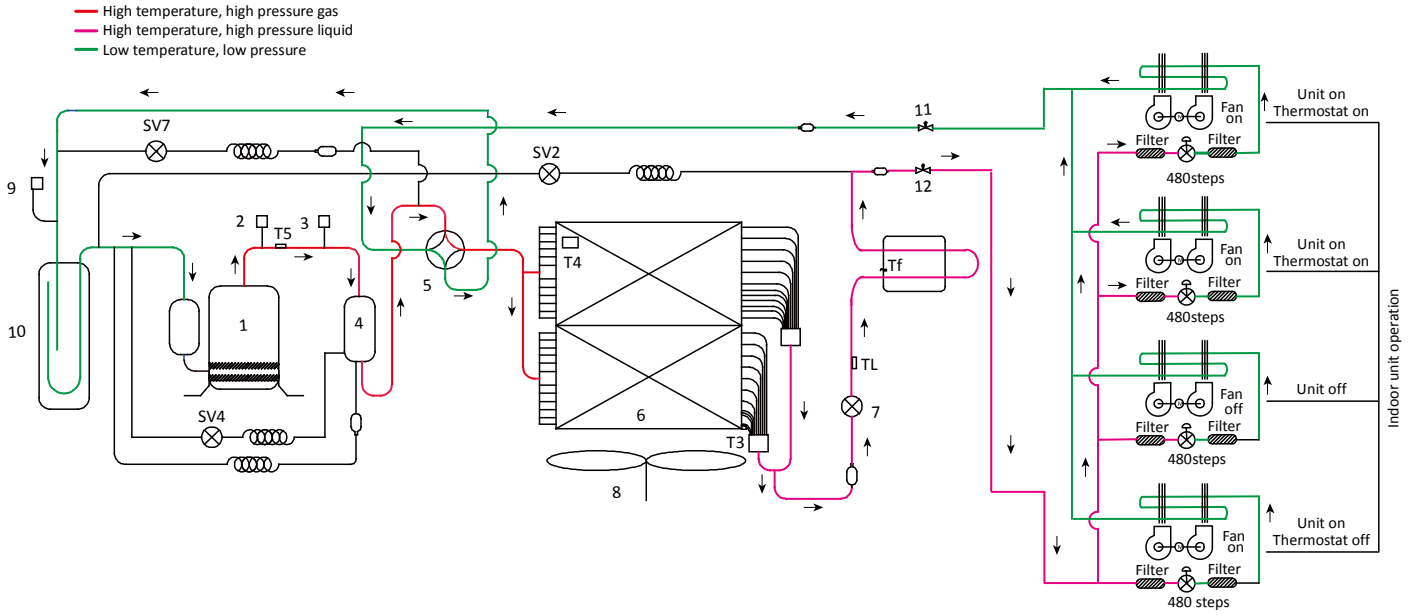

Notes:

1. 7/8/9/10HP outdoor unit doesn't have SV4.

Part 3

Control

1	General Control Scheme Flowchart.....	18
2	Stop Operation	19
3	Standby Control.....	19
4	Startup Control	20
5	Normal Operation Control	21
6	Protection Control	24
7	Special Control.....	26

1 General Control Scheme Flowchart

Sections 3-2 to 3-7 on the following pages detail when each of the controls in the flowchart below is activated.

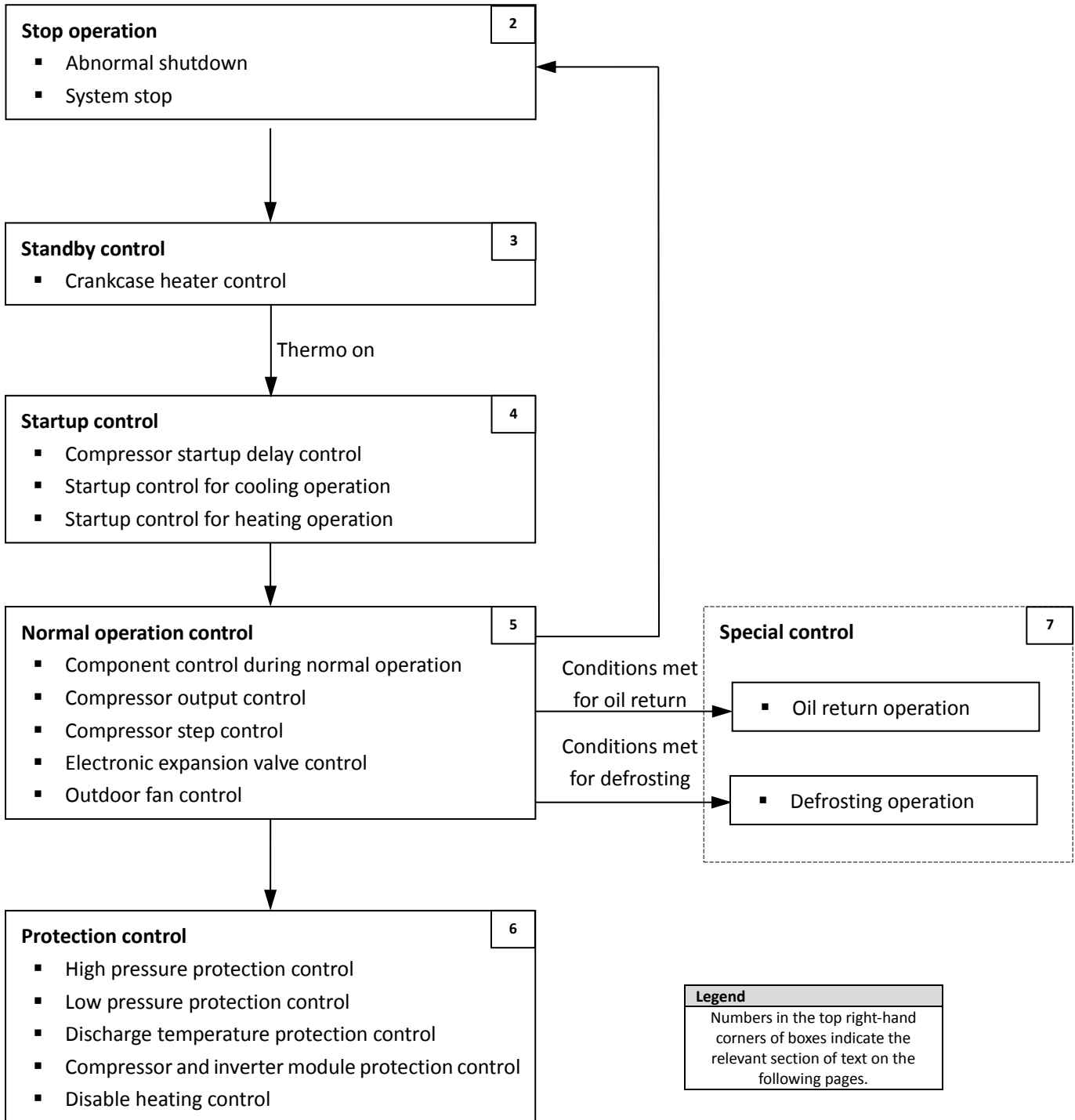

2 Stop Operation

The stop operation occurs for one of the three following reasons:

1. Abnormal shutdown: in order to protect the compressors, if an abnormal state occurs the system makes a 'stop with thermo off' operation and an error code is displayed on the outdoor unit digital displays.
2. The system stops when the set temperature has been reached.

3 Standby Control

3.1 Crankcase Heater Control

The crankcase heater is used to prevent refrigerant from mixing with compressor oil when the compressor is stopped. The crankcase heater is controlled according to outdoor ambient temperature and the compressor on/off state. When the outdoor ambient temperature is above 8°C or the compressor is running, the crankcase heater is off; when the outdoor ambient temperature is at or below 8°C and either the compressor has been stopped for more than 3 hours or the unit has just been powered-on (either manually or when the power has returned following a power outage), the crankcase heater turns on.

4 Startup Control

4.1 Compressor Startup Delay Control

In initial startup control and in restart control (except in oil return operation and defrosting operation), compressor startup is delayed such that a minimum of 7 minutes has elapsed since the compressor stopped, in order to prevent frequent compressor on/off and to equalize the pressure within the refrigerant system.

4.2 Startup Control for Cooling Operation

Table 3-4.1: Component control during startup in cooling mode

Component	Wiring diagram label	7-12HP	Control functions and states
Inverter compressor	COMP	•	Controlled according to load requirement, operating frequency increased by 1 step / sec
Upper DC fan motor	FAN_UP	•	Fan speed ¹ controlled according to discharge pressure (P_c): <ul style="list-style-type: none"> ▪ At initial speed for 20 seconds. ▪ Subsequently, P_c checked every 10 seconds: <ul style="list-style-type: none"> • $P_c \geq 2.8\text{MPa} \Rightarrow$ 1 step increase. • $P_c \leq 2.1\text{MPa} \Rightarrow$ 1 step decrease.
Lower DC fan motor	FAN_DOWN	•	
Electronic expansion valve	EEV	•	Position (steps) from 0 (fully closed) to 480 (fully open), controlled according to discharge temperature
Four-way valve	ST1	•	Off
Solenoid valve (liquid refrigerant injection)	SV2	•	Controlled according to discharge temperature
Solenoid valve ² (oil balance)	SV4	•	Closed for 200 secs, open for 600 secs, then closed
Solenoid valve (indoor units bypass)	SV7	•	Open for 5 minutes, then controlled according to indoor heat exchanger refrigerant outlet temperature ($T2B$)

Notes:

1. Refer to Table 3-5.3 in Part 3, 5.5 "Outdoor Fan Control".
2. 7/8/9/10HP doesn't have SV4.

4.3 Startup Control for Heating Operation

Table 3-4.2: Component control during startup in heating mode

Component	Wiring diagram label	7-12HP	Control functions and states
Inverter compressor	COMP	•	Controlled according to load requirement, operating frequency increased by 1 step / sec
Upper DC fan motor	FAN_UP	•	Fan speed ¹ controlled according to ambient temperature (T4) and discharge pressure (P _c): <ul style="list-style-type: none"> ▪ T4 ≥ 0°C, start up after the compressor running for 10s. ▪ T4 < 0°C, start up after the compressor running for 30s.
Lower DC fan motor	FAN_DOWN	•	
Electronic expansion valve	EEV	•	Position (steps) from 0 (fully closed) to 480 (fully open), controlled according to discharge superheat temperature
Four-way valve	ST1	•	On
Solenoid valve (liquid refrigerant injection)	SV2	•	Controlled according to discharge temperature
Solenoid valve ² (oil balance)	SV4	•	Closed for 200 secs, open for 600 secs, then closed
Solenoid valve (indoor units bypass)	SV7	•	When T4 < 3°C and compressor frequency is ≥ 52Hz , open for 10 minutes and then closed

Notes:

1. Refer to Table 3-5.3 in Part 3, 5.5 "Outdoor Fan Control".
2. 7/8/9/10HP doesn't have SV4.

5 Normal Operation Control

5.1 Component Control during Normal Operation

Table 3-5.1: Component control during normal cooling operation

Component	Wiring diagram label	7-12HP	Control functions and states
Inverter compressor	COMP	●	Controlled according to load requirement
Upper DC fan motor	FAN_UP	●	Fan speed ¹ controlled according to discharge pressure (P _c):
Lower DC fan motor	FAN_DOWN	●	
Electronic expansion valve	EEV	●	Position (steps) from 0 (fully closed) to 480 (fully open), controlled according to discharge temperature
Four-way valve	ST1	●	Off
Solenoid valve (liquid refrigerant injection)	SV2	●	Open when compressor discharge temperature rises above 98°C, closes again once the discharge temperature has fallen below 85°C
Solenoid valve ² (oil balance)	SV4	●	Opens for 3 minutes every 20 minutes
Solenoid valve (indoor units bypass)	SV7	●	Controlled according to indoor heat exchanger refrigerant outlet temperature (T2B)

Notes:

1. Refer to Table 3-5.3 in Part 3, 5.5 “Outdoor Fan Control”.
2. 7/8/9/10HP doesn’t have SV4.

Table 3-5.2: Component control during heating operation

Component	Wiring diagram label	7-12HP	Control functions and states
Inverter compressor	COMP	●	Controlled according to load requirement
Upper DC fan motor	FAN_UP	●	Fan speed ¹ controlled according to ambient temperature (T4) and outdoor unit heat exchanger refrigerant temperature (T3) and discharge pressure (P _c)
Lower DC fan motor	FAN_DOWN	●	
Electronic expansion valve	EEV1	●	Position (steps) from 0 (fully closed) to 480 (fully open), controlled according to discharge superheat temperature
Four-way valve	ST1	●	On
Solenoid valve (liquid refrigerant injection)	SV2	●	Open when compressor discharge temperature rises above 98°C, closes again once the discharge temperature has fallen below 85°C
Solenoid valve ² (oil balance)	SV4	●	Opens for 3 minutes every 20 minutes
Solenoid valve (indoor units bypass)	SV7	●	Open after oil return operation and defrost operation, controlled according to compressor running time and frequency

Notes:

1. Refer to Table 3-5.3 in Part 3, 5.5 “Outdoor Fan Control”.
2. 7/8/9/10HP doesn’t have SV4.

5.2 Compressor Output Control

The compressor rotation speed is controlled according to the load requirement. Before compressor startup, the outdoor unit first estimates the indoor unit load requirement according to the nominal capacity of indoor units currently running, and then correct for ambient temperature. The compressors then start up according to the corrected load requirement.

During operation the compressors are controlled according to the nominal capacity of indoor units currently running and the indoor unit heat exchanger temperatures.

5.3 Compressor Step Control

The running speed of the compressors in rotations per second (rps) is one third of the frequency (in Hz) of the electrical input to the compressor motors. The compressor speed can be altered in increments of 1 rps.

5.4 Electronic Expansion Valve Control

The position of electronic expansion valves EXV is controlled in steps from 0 (fully closed) to 480 (fully open).

In cooling mode:

- When the outdoor unit is in standby:
 - EXV is at position 352 (steps).
- When the outdoor unit is running:
 - EXV is controlled according to discharge temperature.

In heating mode:

- When the outdoor unit is in standby:
 - EXV is at position 352 (steps).
- When the outdoor unit is running:
 - EXV is controlled according to discharge superheat.

5.5 Outdoor Fan Control

The speed of the outdoor unit fans is adjusted in steps, as shown in Table 3-5.3.

Table 3-5.3: Outdoor fan speed steps

Fan speed index	7/8HP		9HP		10/12HP	
	Upper fan ¹	Lower fan ²	Upper fan ¹	Lower fan ²	Upper fan ¹	Lower fan ²
1	0	180	0	180	0	180
2	0	310	0	310	0	310
3	310	340	310	340	310	340
4	380	400	380	400	380	400
5	460	480	460	480	460	480
6	540	560	540	560	540	560
7	620	640	620	640	620	640
8	740	760	740	760	740	760
9	800	820	820	840	800	820
10	820	840	840	860	860	880
11	840	860	840	860	900	900

Notes:

1. The upper fan is labelled FAN_UP in the wiring diagram. Refer to the Iflex IV i Engineering Data Book Part 2, 5 "Wiring diagram".
2. The lower fan is labelled FAN_DOWN in the wiring diagram. Refer to the Iflex IV i Engineering Data Book Part 2, 5 "Wiring diagram".

6 Protection Control

6.1 High Pressure Protection Control

This control protects the system from abnormally high pressure and protects the compressors from transient spikes in pressure.

Figure 3-6.1: High pressure protection control

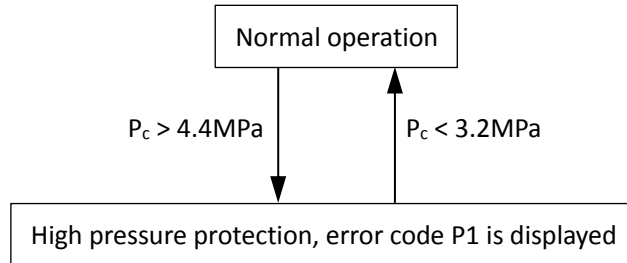

Notes:

1. P_c : Discharge pressure

When the discharge pressure rises above 4.4MPa the system displays P1 protection and the unit stops running. When the discharge pressure drops below 3.2MPa, the compressor enters re-start control.

6.2 Low Pressure Protection Control

This control protects the system from abnormally low pressure and protects the compressors from transient drops in pressure.

Figure 3-6.2: Low pressure protection control

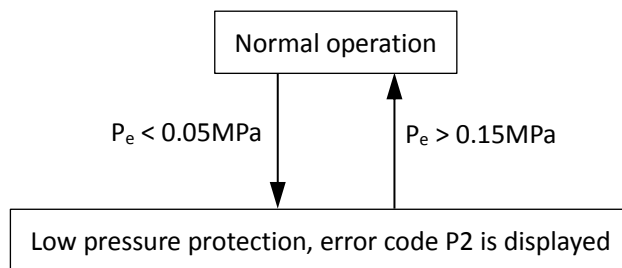

Notes:

1. P_e : Suction pressure

When P2 protection occurs 3 times in 60 minutes, the H5 error is displayed. When an H5 error occurs, a manual system restart is required before the system can resume operation.

6.3 Discharge Temperature Protection Control

This control protects the compressors from abnormally high temperatures and transient spikes in temperature. It is performed for each compressor.

Figure 3-6.3: High discharge temperature protection control

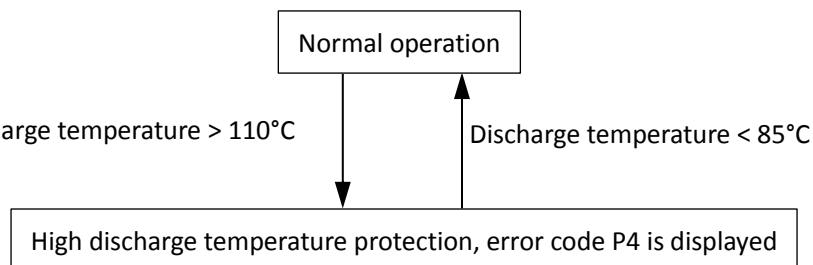

When the discharge temperature rises above 110°C the system displays P4 protection and the unit stops running. When the discharge temperature drops below 85°C, the compressor enters re-start control.

When P4 protection occurs 3 times in 100 minutes, the H6 error is displayed. When an H6 error occurs, a manual system restart is required before the system can resume operation.

6.4 Compressor and Inverter Module Protection Control

This control protects the compressors from abnormally high currents and protects the inverter modules from abnormally high temperatures.

Figure 3-6.4: Compressor current protection control

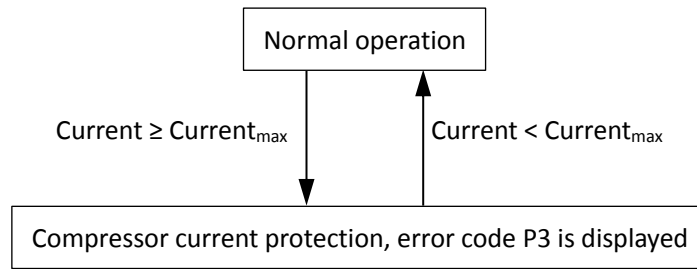

Compressor model	ATQ580D66UNT	LNB65FAGMC
Current_{max}	29A	29A

Figure 3-6.5: Inverter module temperature protection control

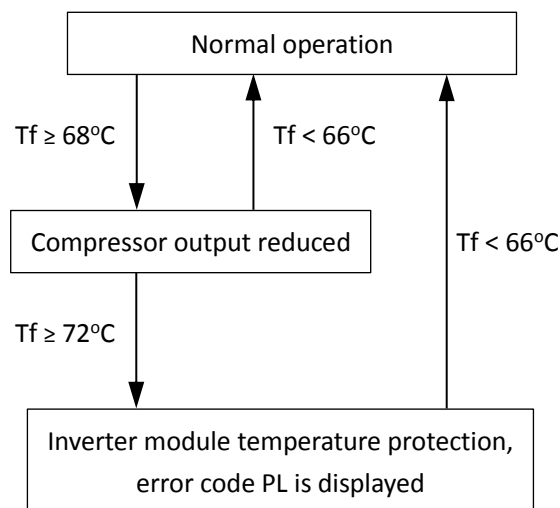

- Notes:
1. Tf: Heat sink temperature

6.5 Disable Heating Control

When the outdoor ambient temperature rises above or equal to 28°C heating mode is disabled to prevent the mechanical load on compressors becoming too high and to prevent low compression ratios which can result in insufficient compressor internal oil lubrication. When the outdoor ambient temperature drops below 27°C, the compressor enters re-start control.

Figure 3-6.6: Disable heating control

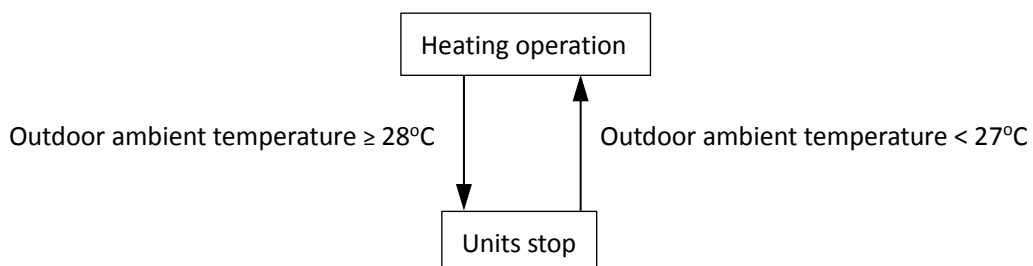

7 Special Control

7.1 Oil Return Operation

In order to prevent compressors from running out of oil, the oil return operation is conducted to recover oil that has flowed out of the compressor(s) and into the piping system. This operation is performed for all units including units that are in standby. When the outdoor unit is running in oil return operation, the digital display on outdoor main PCB will display “d0”.

Timing of oil return operation:

- When the initial cumulative operating time reaches 140 minutes and then every 8 hours.

Tables 3-7.1 and 3-7.2 show component control during oil return operation in cooling mode.

Table 3-7.1: Outdoor unit component control during oil return operation in cooling mode

Component	Wiring diagram label	7-12HP	Control functions and states
Inverter compressor	COMP	●	Controlled according to load requirement
Upper DC fan motor	FAN_UP	●	Fan speed controlled according to discharge pressure
Lower DC fan motor	FAN_DOWN	●	
Electronic expansion valve	EEV	●	Position 300 (steps)
Four-way valve	ST1	●	Off
Solenoid valve (liquid refrigerant injection)	SV2	●	Normal control
Solenoid valve ¹ (oil balance)	SV4	●	Normal control
Solenoid valve (indoor units bypass)	SV7	●	Normal control

Notes:

1. 7/8/9/10HP doesn't have SV4.

Table 3-7.2: Indoor unit component control during oil return operation in cooling mode

Component	Unit state	Control functions and states
Fan	Thermo on	Remote controller setting
	Standby	Off
	Thermo off	Off
Electronic expansion valve	Thermo on	Normal control
	Standby	300 (steps)
	Thermo off	300 (steps)

Tables 3-7.3 and 3-7.4 show component control during oil return operation in heating mode.

Table 3-7.3: Outdoor unit component control during oil return operation in heating mode

Component	Wiring diagram label	7-12HP	Control functions and states
Inverter compressor	COMP	●	Controlled according to load requirement
Upper DC fan motor	FAN_UP	●	Fan speed controlled according to outdoor ambient temperature (T4), outdoor unit heat exchanger refrigerant temperature (T3) and discharge pressure (Pc)
Lower DC fan motor	FAN_DOWN	●	
Electronic expansion valve	EEV1	●	Position 350 (steps)
Four-way valve	ST1	●	Off
Solenoid valve (liquid refrigerant injection)	SV2	●	Normal control
Solenoid valve ¹ (oil balance)	SV4	●	Normal control
Solenoid valve (indoor units bypass)	SV7	●	Normal control

Notes:

1. 7/8/9/10HP doesn't have SV4.

Table 3-7.4: Indoor unit component control during oil return operation in heating mode

Component	Unit state	Control functions and states
Fan	Thermo on	Normal control
	Standby	Off
	Thermo off	Off
Electronic expansion valve	Thermo on	Normal control
	Standby	480 (steps)
	Thermo off	480 (steps)

7.2 Defrosting Operation

In order to recover heating capacity, the defrosting operation is conducted when the outdoor unit heat exchanger is performing as an evaporator. The defrosting operation is controlled according to outdoor ambient temperature, outdoor heat exchanger temperature, indoor heat exchanger temperature and outdoor unit running time. When the outdoor unit is running in defrosting, the digital display on outdoor main PCB will display “df”.

Table 3-7.5: Outdoor unit component control during defrosting operation

Component	Wiring diagram label	7-12HP	Control functions and states
Inverter compressor	COMP	●	Fixed frequency
Upper DC fan motor	FAN_UP	●	Off
Lower DC fan motor	FAN_DOWN	●	
Electronic expansion valve	EEV1	●	Position 480 (steps)
Four-way valve	ST1	●	Off
Solenoid valve (liquid refrigerant injection)	SV2	●	Normal control
Solenoid valve ¹ (oil balance)	SV4	●	Normal control
Solenoid valve (indoor units bypass)	SV7	●	Normal control

Notes:

1. 7/8/9/10HP doesn't have SV4.

Table 3-7.6: Indoor unit component control during defrosting operation

Component	Unit state	Control functions and states
Fan	Thermo on	Off
	Standby	Off
	Thermo off	Off
Electronic expansion valve	Thermo on	480 (steps)
	Standby	480 (steps)
	Thermo off	480 (steps)

Part 4

Field Settings

1 Outdoor Unit Field Settings 30

1 Outdoor Unit Field Settings

1.1 PCB Switches and Switch Settings

Figure 4-1.2: Outdoor unit main PCB switches

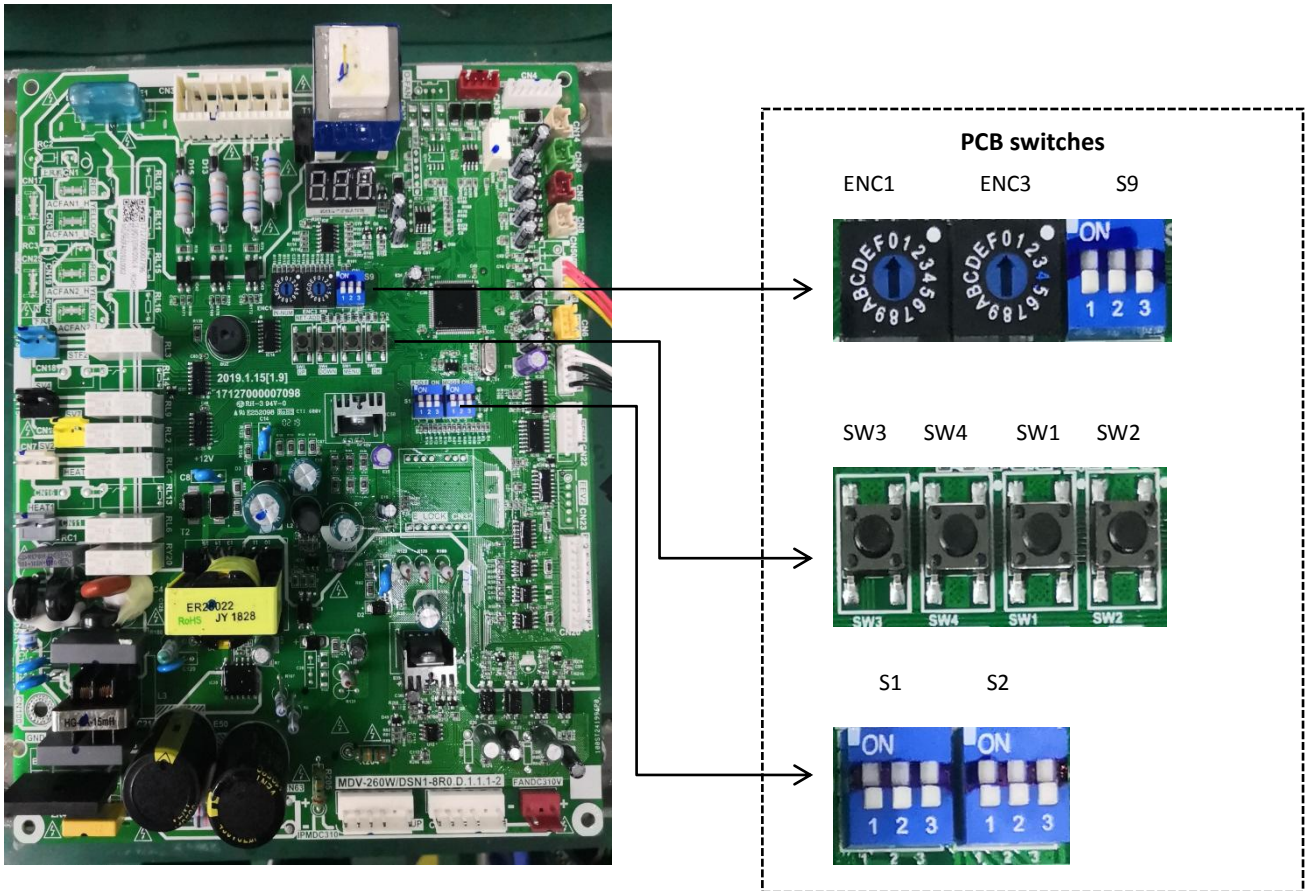

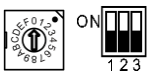
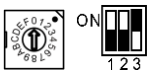

























Table 4-1.2: Outdoor unit main PCB switch settings

Switch	Setting	Switch positions ¹	Description
	Number of indoor units		The number of indoor units is in the range 0-15 0-9 on ENC1 indicate 0-9 indoor units; A-F on ENC1 indicate 10-15 indoor units
			The number of indoor units is in the range 16-31 0-9 on ENC1 indicate 16-25 indoor units; A-F on ENC1 indicate 26-31 indoor units
	Network address		Only 0, 1, 2, 3, 4, 5, 6, 7 should be selected (default is 0)
	Indoor unit generation		Connected to 2nd generation AC/DC indoor unit (default)
			Connected to 1st generation AC/DC indoor unit ²
	Clear indoor unit addresses		No action (default)
			Clear indoor unit addresses
	Reserved		Reserved
	Priority mode ³		Auto priority (default)
			Cooling priority
			First on priority
			Heating only
			Cooling only
			Heating priority ³
	Outdoor unit capacity ⁵		10HP
			9HP
			12HP
			7/8HP
	Reserved		Reserved

Notes:

1. Black denotes the switch position.
2. When the system connected to both 2nd generation IDU and 1st generation IDU, SW1-1 should be positioned to 1. The VRF-AHU control kit should be treated as 1st generation IDU.
3. Refer to Part 4, 1.2.1 "Priority mode setting".
4. When S2 in other switch positions not mentioned above indicates heating priority mode.
5. Switch S9-1 is factory-set and its setting should not be changed.

1.2 Priority Mode Setting on Main PCB

Priority mode can only be set on the outdoor unit. When an indoor unit is in mode conflict with the outdoor units the unit displays the mode conflict error. The digital display on indoor main PCB will display error code E0.

Figure 4-1.2: Indoor unit digital displays



There are five priority mode options:

Auto priority mode (default)

In auto priority mode, the outdoor unit will operate in heating priority mode or cooling priority mode according to the outdoor ambient temperature.

- When the outdoor ambient temperature is below 13°C, the outdoor units run in heating priority mode. The heating priority mode does not change until the outdoor ambient temperature is above 18°C.
- When the outdoor ambient temperature is above 18°C, the outdoor units run in cooling priority mode. The cooling priority mode does not change until the outdoor ambient temperature is below 13°C.
- When the outdoor unit restarts under the outdoor ambient between 13°C and 18°C, the outdoor unit runs the same priority as before the last stop.
- When the outdoor unit is initial startup under outdoor ambient temperature between 13°C and 18°C, the outdoor unit runs in heating priority mode.

Figure 4-1.3: Auto priority mode control

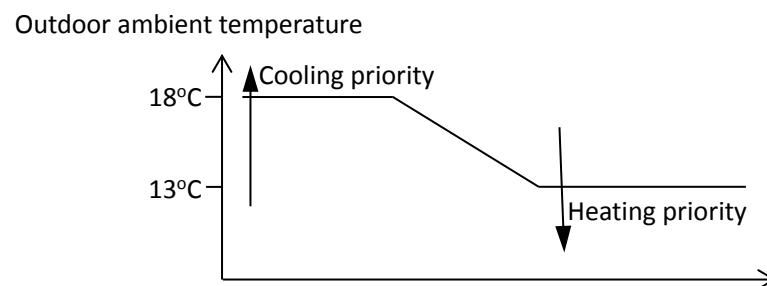

(1) Heating priority mode:

- During cooling operation:** If an indoor unit requests heating, the outdoor unit stops and then restarts in heating mode after 5 minutes. Indoor units requesting heating then start in heating mode and indoor units requesting cooling display the mode conflict error.
- During heating operation:** If an indoor unit requests cooling, the outdoor unit ignores the request and continues to run in heating mode. The indoor unit requesting cooling displays the mode conflict error. If all the indoor units requesting heating are later turned off and one or more indoor units are still requesting cooling, the outdoor unit restarts in cooling mode after 5 minutes and any indoor units requesting cooling then start in cooling mode.

(2) Cooling priority mode:

- During heating operation:** If an indoor unit requests cooling, the outdoor unit stops and then restarts in cooling mode after 5 minutes. Indoor units requesting cooling then start in cooling mode and indoor units requesting heating display the mode conflict error.
- During cooling operation:** If an indoor unit requests heating, the outdoor units ignore the request and continue to run in cooling mode. The indoor unit requesting heating displays the mode conflict error. If all the indoor units requesting cooling are later turned off and one or more indoor units are still requesting heating, the outdoor unit restarts in heating mode after 5 minutes and any indoor units requesting heating then start in heating mode.

Cooling priority mode

Refer to above "1.2. Cooling priority mode" descriptions.

First on priority mode:

The outdoor unit operates in the mode of the first on indoor unit is being requested. Indoor units that are in a mode different to the first on unit display the mode conflict error.

Heating only mode

The outdoor unit only operates in heating mode. Indoor units requesting heating operate in heating mode. Indoor units requesting cooling or in fan only mode display the mode conflict error.

Cooling only mode

The outdoor unit only operates in cooling mode. Indoor units requesting cooling operate in cooling mode; indoor units in fan only mode operate in fan only mode. Indoor units requesting heating display the mode conflict error.

Part 5

Electrical Components and Wiring Diagrams

1	Outdoor Unit Electric Control Box Layout	36
2	Outdoor Unit Main PCB.....	37
3	Compressor Inverter Module and Filter Board.....	44
4	Wiring Diagrams.....	48

1 Outdoor Unit Electric Control Box Layout

Figure 5-1.1: Front view of electric control box

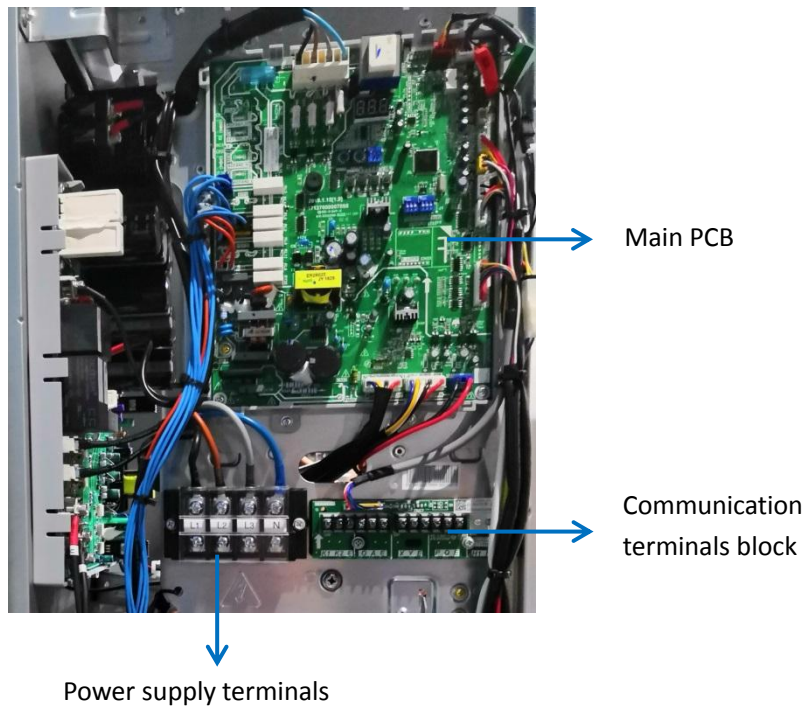
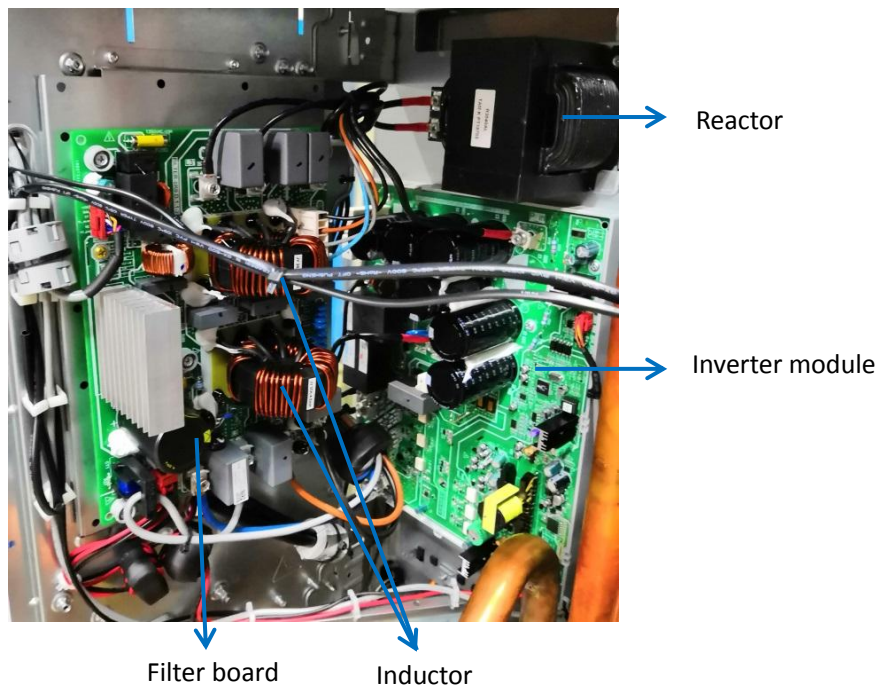

Figure 5-1.2: Rear view of electric control box



2 Outdoor Unit Main PCB

2.1 Ports

Figure 5-2.1: Outdoor unit main PCB ports¹

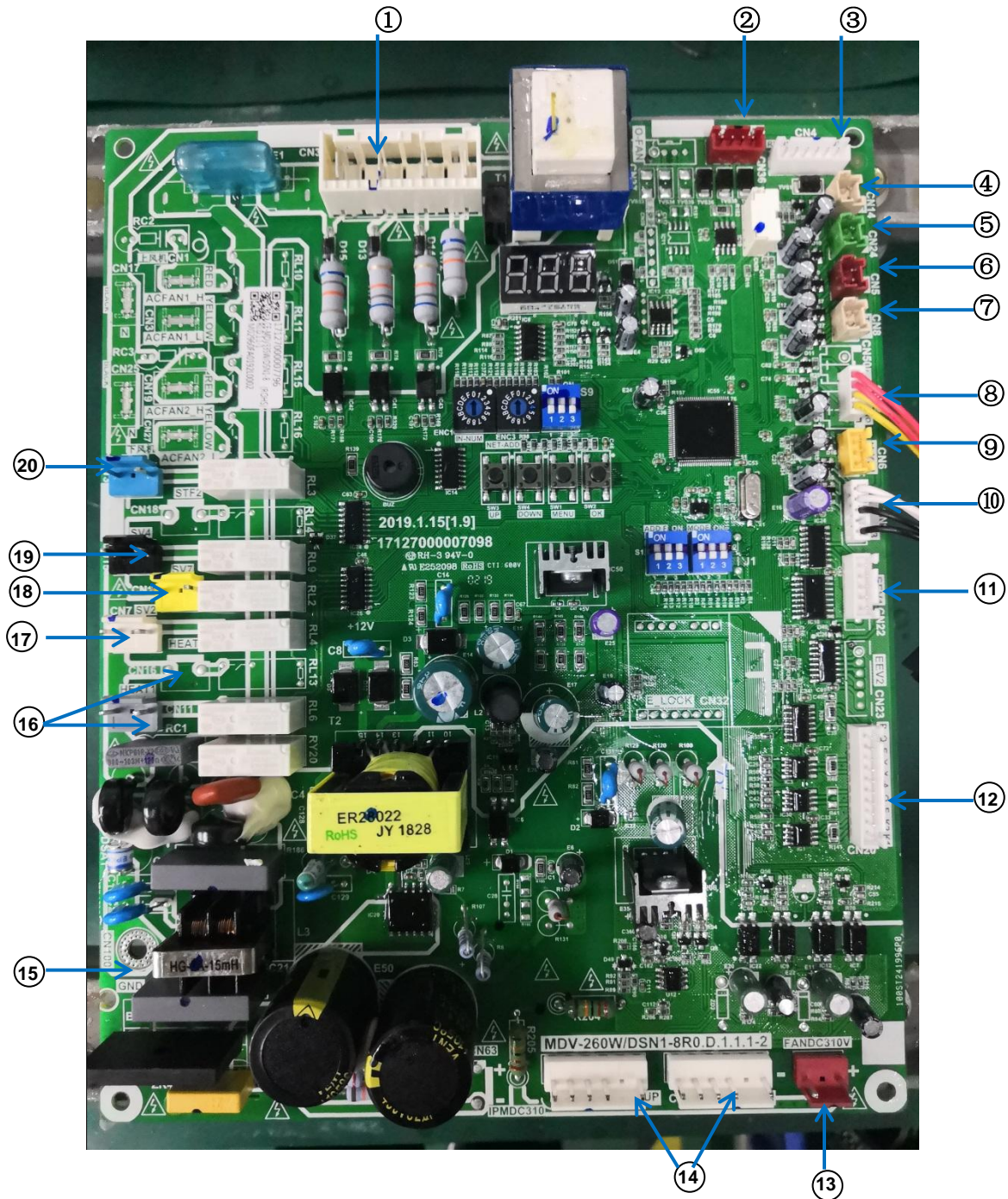

Notes:

1. Label descriptions are given in Table 5-2.1.

Table 5-2.1: Main PCB ports

Label in Figure 5-2.1	Port code	Content	Port voltage
1	CN30	Power input of main board	220V AC between A/B/C and N; 380V AC between A,B and C
2	CN36	Inverter module connection	0V or 5V DC
3	CN4	Control port of filter board	0V or 12V DC
4	CN14	Heat sink temperature sensor (Tf) connection	0-5V DC (varying)
5	CN24	Refrigerant cooling pipe temperature sensor (TL) connection	0-5V DC (varying)
6	CN5	Discharge pipe temperature sensor (T5) connection	0-5V DC (varying)
7	CN8	Heat exchanger temperature sensor (T3A) connection (Reserved)	0-5V DC (varying)
8	CN12	High pressure sensor and low pressure sensor connections	0-5V DC (varying)
9	CN6	High pressure switch connection	0V or 5V DC
10	CN9	Heat exchanger temperature sensor outlet (T3) and ambient temperature sensor (T4) connections	0-5V DC (varying)
11	CN22	EEV drive port	0V or 12V DC
12	CN20	Communication port	0-5V DC (varying)
13	CN53	DC fan motor power supply connection	310V DC
14	CN107 CN109	DC fan motor control port	0-310V DC (varying)
15	CN100	Ground connection	
16	CN11 CN16	Power supply to compressor crankcase heater	220V AC
17	CN7	Solenoid valve SV2 drive port	220V AC
18	CN10	Solenoid valve SV7 drive port	220V AC
19	CN15	Solenoid valve SV4 drive port	220V AC
20	CN13	Four-way valve drive ports	220V AC

2.2 Components

2.2.1 Layout

Figure 5-2.2: Outdoor unit main PCB components

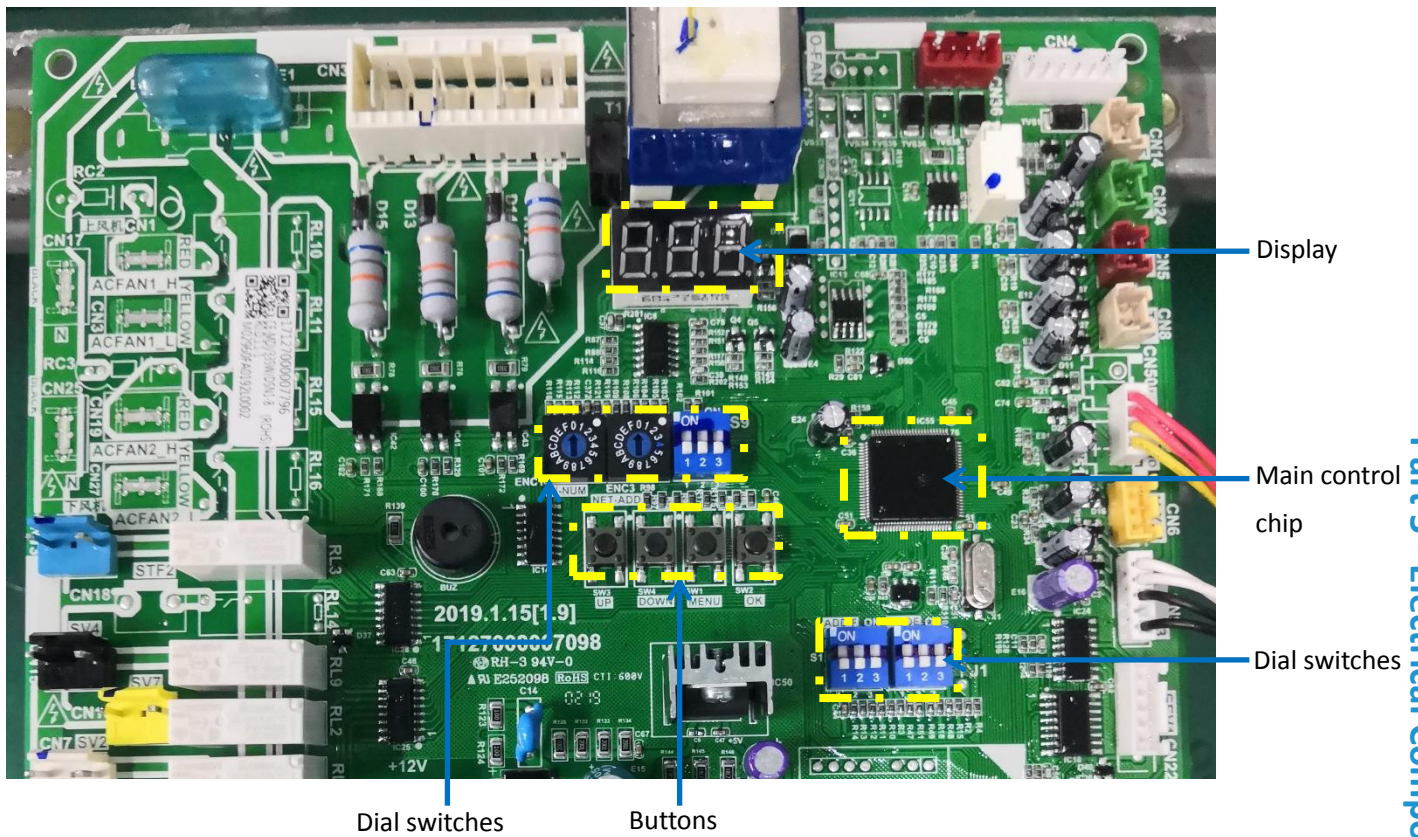

2.2.2 Function of buttons

Table 5-2.2: Function of buttons SW1 to SW4

Button	Function
SW3 (UP)	In menu mode: previous and next buttons for menu modes.
SW4 (DOWN)	
SW1 (MENU)	Enter / exit menu mode.
SW2 (OK)	Confirm to enter specified menu mode.

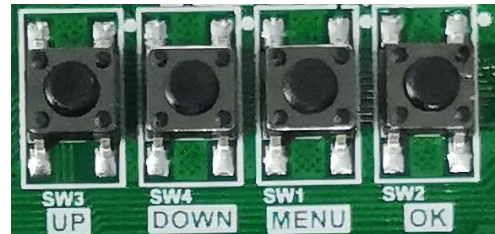

2.2.3 Menu mode

1. Long press SW1 "MENU" button for 5 seconds to enter menu mode, and the digital display displays "n1";
2. Press SW3 / SW4 "UP / DOWN" button to select the first level menu "n1", "n2", "n3", "n4", "nb" or "nF";
3. Press SW2 "OK" button to enter specified first level menu, for example, enter "n3" mode;
4. Press SW3 / SW4 "UP / DOWN" button to select the second level menu from "n31" to "n34";
5. Press SW2 "OK" button to enter specified second level menu, for example, enter "n32" mode;

Menu mode selection flowchart:

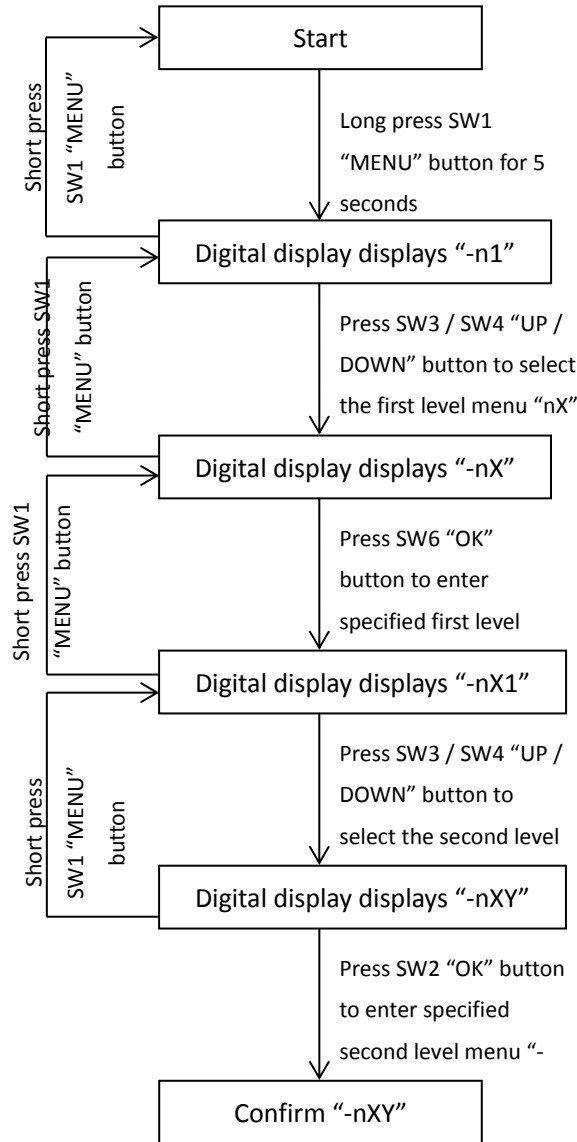

Menu mode function:

Table 5-2.3: Menu mode function

Digital display content	Menu mode	Remarks
n14	Force cooling mode	All indoor units running in cooling mode
n16	Maintenance mode	The system does not check the indoor units' number.
n27	Vacuum mode	It is only used in maintenance process. The digital display displays "R01", and all solenoid valves are opened and EXVs are positioned to 480 steps.
n31	History error codes	Displays recent 10 history error codes
n32	Cleaning history error codes	
n34	Factory reset	
nb3	Exit auto power save mode	
nb4	Enter auto power save mode	
nF1	Adjust T2	Only 40 to 50 could be selected (default value is 44).
nF2	Adjust T2B	Only 5 to 15 could be selected (default value is 8).

How to exit specified menu mode:

Table 5-2.4: Exit specified menu mode method:

Menu mode	Manual exit method	Automatic exit method
Debug mode 1 (2)	Long press SW2 "OK" button when the digital display is not in menu selection state	After running 60 minutes
Maintenance mode	/	After running 60 minutes
Vacuum mode	Long press SW2 "OK" button when the digital display is not in menu selection state	After running 8 hours
Auto power save mode	Select "nb3"	/

In the non-menu selection state, long press SW2 "OK" button for 3s, it will automatically exit all test modes.

2.2.4 System check button

Before pressing UP or DOWN button, make sure that the system has been operating steadily for more than one hour. On pressing UP or DOWN button, the parameters listed in Table 5-2.5 will be displayed in sequence.

Table 5-2.5: System check

DSP content	Parameters displayed on DSP	Remarks
0.--	Unit capacity (Hp)	Actual value = value displayed
1.--	Setting number of indoor units	
2.--	Operating mode	Refer to Note 1
3.--	Fan speed index	Refer to Note 2
4.--	Total capacity of outdoor unit	
5.--	Total capacity requirement of indoor units	
6.--	Main heat exchanger pipe (T3) temperature (°C)	Actual value = value displayed
7.--	Outdoor ambient (T4) temperature (°C)	Actual value = value displayed
8.--	Inverter compressor discharge temperature (°C)	Actual value = value displayed
9.--	Invert module (TF) temperature (°C)	Actual value = value displayed
10.--	Refrigerant cooling pipe (TL) temperature (°C)	Actual value = value displayed
11.--	Compressor discharge pressure (MPa)	Actual value = value displayed × 0.1
12.--	Discharge superheat degree (°C)	Actual value = value displayed
13.--	EXVA position	Actual value = value displayed × 8
14.--	Actual current (A)	Actual value = value displayed
15.--	Inverter compressor current (A)	Actual value = value displayed
16.--	Actual voltage (V)	Actual value = value displayed
17.--	DC bus voltage (V)	Actual value = value displayed
18.--	Indoor heat exchanger pipe (T2/T2B) temperature (°C)	Actual value = value displayed
19.--	Priority mode	Refer to Note 3
20.--	Number of indoor units currently in communication with outdoor unit	Actual value = value displayed
21.--	Number of indoor units currently operating	Actual value = value displayed
22.--	Most recent error or protection code	"nn" is displayed if no error or protection events have occurred since start-up
23.--	Software version	
-- --	--	End

Notes:

1. Operating mode:
 - 0: off; 2: cooling; 3: heating; 4: forced cooling.
2. The fan speed index is related to the fan speed in rpm and can take any integer value in the range 1 (slowest) to 11 (fastest).
3. Priority mode:
 - 0: heating priority; 1: cooling priority; 2: first ON priority; 3: heating only; 4: cooling only; 5: test mode 1; 6: test mode 2.

2.2.5 Digital display output

Table 5-2.6: Digital display output in different operating states

Outdoor unit state	Parameters displayed on DSP	
Standby	The number of indoor units in communication with the outdoor unit	
Normal operation	Frequency limitation code ¹ and running speed of the compressor in rotations per second	
Error or protection	Error or protection code	
In menu mode	Refer to Table 5-2.3	
System check	Refer to Table 5-2.5	

Notes:

1. Frequency limitation code:

- P: Compressor discharge temperature frequency limitation; C: Pressure frequency limitation; A: Ambient temperature frequency limitation; F: Heat sink temperature frequency limitation; U: Voltage frequency limitation; H: Current frequency limitation; d: DC voltage frequency limitation.

3 Compressor Inverter Module and Filter Board

3.1 Inverter module ports

Figure 5-3.1: Outdoor unit inverter module ports¹

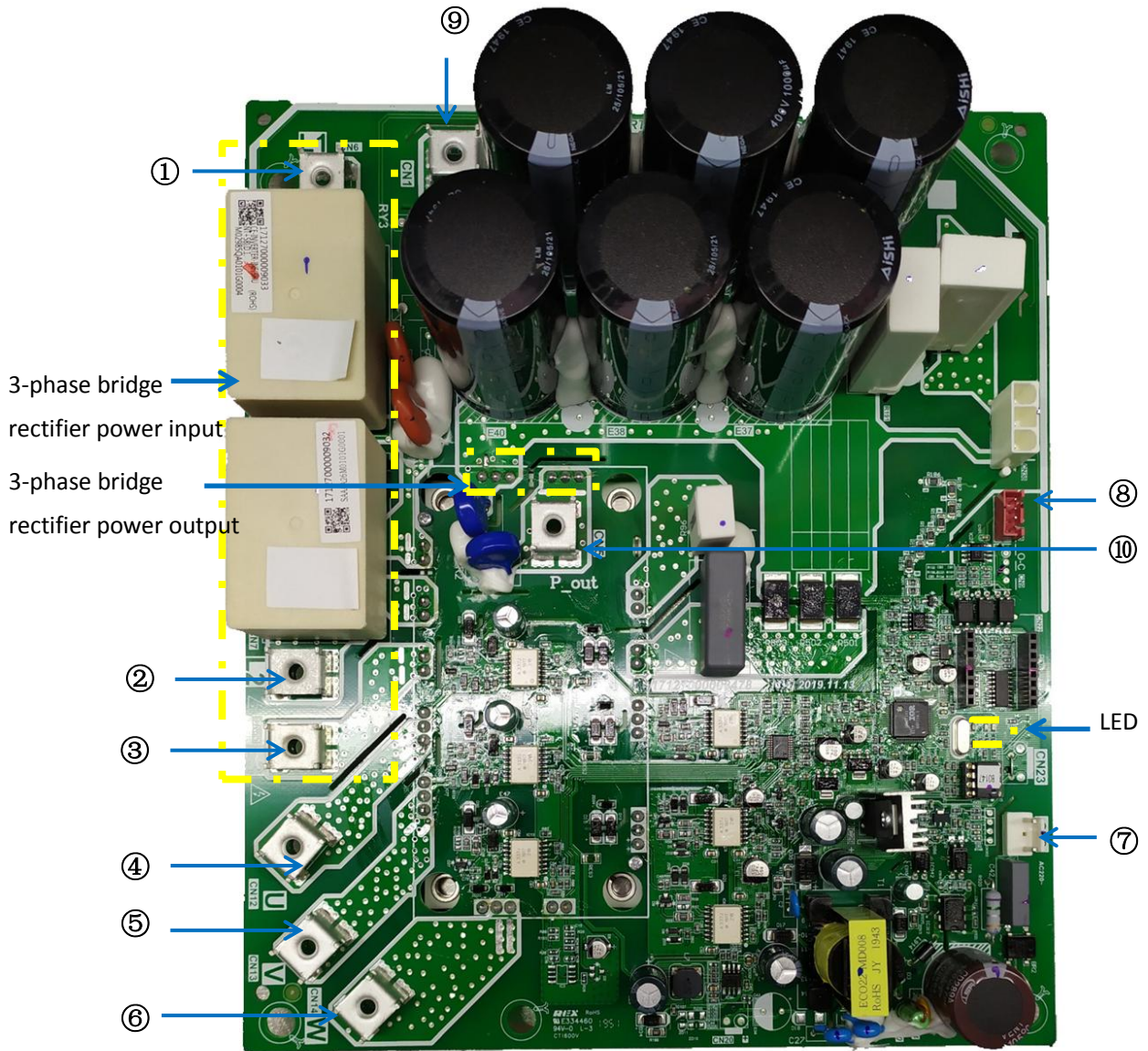

Notes:

1. Label descriptions are given in Table 5-3.1.

Table 5-3.1: Inverter module ports

Label in Figure 5-2.1	Port code	Content	Port voltage
1	CN6	Power input L1 of inverter module	380V AC
2	CN7	Power input L2 of inverter module	380V AC
3	CN11	Power input L3 of inverter module	380V AC
4	CN12	Power output U of inverter module to compressor	Above 156V DC (varying according to frequency)
5	CN13	Power output V of inverter module to compressor	Above 156V DC (varying according to frequency)
6	CN14	Power output W of inverter module to compressor	Above 156V DC (varying according to frequency)
7	CN2	DC power supply input	310V DC
8	CN8	Main PCB connection	0-5V DC (varying)
9	CN1	DC bus input connect to reactor	350-640V DC (varying)
10	CN5	DC bus output connect to reactor	350-640V DC (varying)

LED indicators LED1 and LED2

Table 5-3.2: LED indicators LED1 and LED2

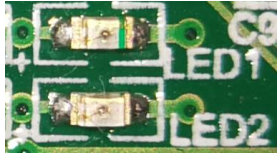
Indicator	LED indicator function and status	
LED 1	Inverter module operating indicator. Continuously on if the compressor is running normally and flashing if an inverter module error has occurred ¹ .	
LED 2	Inverter module error indicator. Continuously on if an inverter module error has occurred ¹ .	

Note:

1. If an inverter module error occurs, refer to Part 6, "H4 Troubleshooting". The error code is displayed on the digital display.

3.2 Filter board ports

Figure 5-3.2: Outdoor unit filter board ports¹

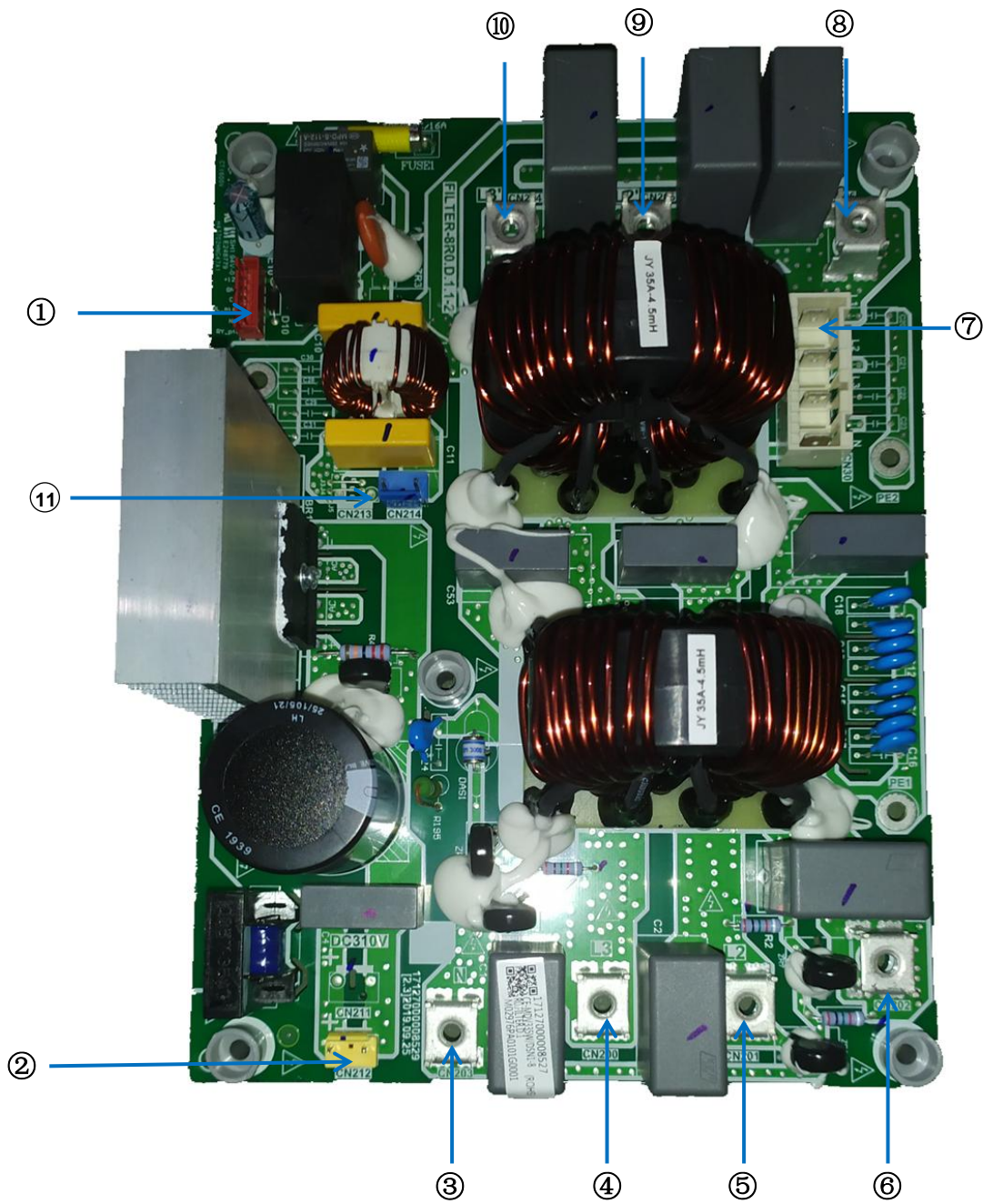

Notes:

1. Label descriptions are given in Table 5-3.3.

Table 5-3.3: Filter board ports

Label in Figure 5-3.2	Port code	Content	Port voltage
1	CN8	Control port of filter board	12V DC
2	CN212	Power supply to DC fan motor (CN212) of filter board	310V DC
3	CN203	Power input N of filter board	220V AC between L1/L2/L3 and N; 380V AC between L1,L2 and L3
4	CN200	Power input L1 of filter board	220V AC between L1/L2/L3 and N; 380V AC between L1,L2 and L3
5	CN201	Power input L2 of filter board	220V AC between L1/L2/L3 and N; 380V AC between L1,L2 and L3
6	CN202	Power input L3 of filter board	220V AC between L1/L2/L3 and N; 380V AC between L1,L2 and L3
7	CN30	Power supply output to main PCB	220V AC between L1/L2/L3 and N; 380V AC between L1,L2 and L3
8	CN206	Power output L1 of filter board	220V AC between L1/L2/L3 and N; 380V AC between L1,L2 and L3
9	CN205	Power output L2 of filter board	220V AC between L1/L2/L3 and N; 380V AC between L1,L2 and L3
10	CN204	Power output L3 of filter board	220V AC between L1/L2/L3 and N; 380V AC between L1,L2 and L3
11	CN214	Power supply to inverter board (CN214) of filter board	220V AC

Iflex IV I VRF 50/60Hz

4 Wiring Diagrams

Figure 5-4.1: Wiring diagram

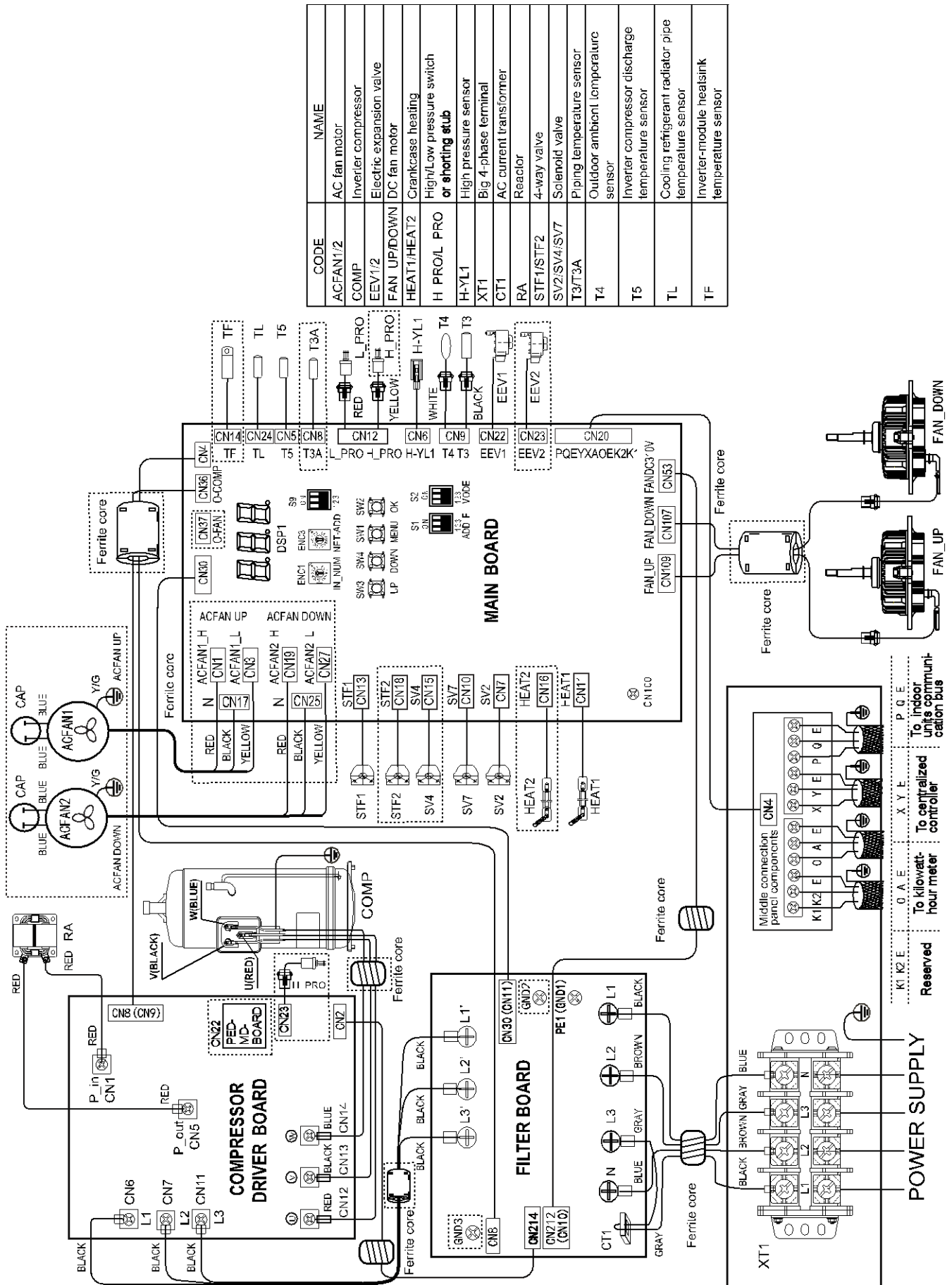

CODE	NAME
ACFAN1/2	AC fan motor
COMP	Inverter compressor
EEV1/2	Electric expansion valve
FAN UP/DOWN	DC fan motor
HEAT1/HEAT2	Crankcase heating
H PRO/L PRO	High/Low pressure switch or shoring stub
H-YL1	High pressure sensor
XT1	Big 4-phase terminal
CT1	AC current transformer
RA	Reactor
STF1/STF2	4-way valve
SV2/SV4/SV7	Solenoid valve
T3/T3A	Piping temperature sensor
T4	Outdoor ambient temperature sensor
T5	Inverter compressor discharge temperature sensor
TL	Cooling refrigerant radiator pipe temperature sensor
TF	Inverter-module heatsink temperature sensor

Part 6

Diagnosis and Troubleshooting

1	Error Code Table	50
2	Troubleshooting	51
3	Appendix to Part 6.....	99

1 Error Code Table

Table 6-1.1: Error code table

Error code ¹	Content	Remarks	Manual re-start required ¹
E1	Phase sequence error	Displayed on the outdoor unit PCB	Yes
E2	Communication error between indoor and outdoor units	Displayed on the outdoor unit PCB	No
E4	Outdoor heat exchanger temperature sensor (T3) error or outdoor ambient temperature sensor (T4) error	Displayed on the outdoor unit PCB	No
E5	Abnormal power supply voltage	Displayed on the outdoor unit PCB	No
E6	DC fan motor error	Displayed on the outdoor unit PCB	No
Eb	E6 error appears 6 times in 1 hour	Displayed on the outdoor unit PCB	Yes
E7	Outdoor compressor discharge temperature sensor (T5) error	Displayed on the outdoor unit PCB	No
EH	Outdoor refrigerant cooling pipe temperature sensor (TL) error	Displayed on the outdoor unit PCB	No
F1	DC bus voltage error	Displayed on the outdoor unit PCB	No
H0	Communication error between main control chip and inverter driver chip	Displayed on the outdoor unit PCB	No
H4	Inverter module protection, P6 protection appears three times in 30 minutes	Displayed on the outdoor unit PCB	Yes
H5	P2 protection appears three times in 60 minutes	Displayed on the outdoor unit PCB	Yes
H7	Number of indoor units detected by outdoor unit not same as number set on main PCB	Displayed on the outdoor unit PCB	No
H8	High pressure sensor error	Displayed on the outdoor unit PCB	No
P1	Discharge pipe high pressure protection	Displayed on the outdoor unit PCB	No
P2	Suction pipe low pressure protection	Displayed on the outdoor unit PCB	No
P3	Compressor current protection	Displayed on the outdoor unit PCB	No
P4	Discharge temperature protection	Displayed on the outdoor unit PCB	No
P5	Outdoor heat exchanger temperature protection	Displayed on the outdoor unit PCB	No
P8	Typhoon protection	Displayed on the outdoor unit PCB	No
PL	Heat sink high temperature protection	Displayed on the outdoor unit PCB	No
L0	Inverter module protection	Displayed on the outdoor unit PCB	Yes
L1	DC bus low voltage protection	Displayed on the outdoor unit PCB	Yes
L2	DC bus high voltage Heat sink temperature sensor protection	Displayed on the outdoor unit PCB	Yes
L4	MCE error	Displayed on the outdoor unit PCB	Yes
L5	Zero speed protection	Displayed on the outdoor unit PCB	Yes
L7	Phase sequence error	Displayed on the outdoor unit PCB	Yes
L8	Compressor frequency variation greater than 15Hz within one second protection	Displayed on the outdoor unit PCB	Yes
L9	Actual compressor frequency differs from target frequency by more than 15Hz protection	Displayed on the outdoor unit PCB	Yes

Notes:

1. For some error codes, a manual restart is required before the system can resume operation.

2 Troubleshooting

2.1 Warning

Warning

- All electrical work must be carried out by competent and suitably qualified, certified and accredited professionals and in accordance with all applicable legislation (all national, local and other laws, standards, codes, rules, regulations and other legislation that apply in a given situation).
- Power-off the outdoor units before connecting or disconnecting any connections or wiring, otherwise electric shock (which can cause physical injury or death) may occur or damage to components may occur.

2.2 E1: Phase sequence error

2.2.1 Digital display output



2.2.2 Description

- Phase sequence error.
- The system stops running.
- Error code is displayed on the outdoor unit PCB.

2.2.3 Trigger / recover condition

- Trigger condition: Wrong phase connection for 1.6s or phase missing for 48s.
- Recover condition: Correct phase connection.
- Reset method: Manually restart.

2.2.4 Possible causes

- Power supply phases not connected in correct sequence.
- Power supply terminals loose.
- Power supply abnormal.
- Main PCB damaged.

2.2.5 Procedure

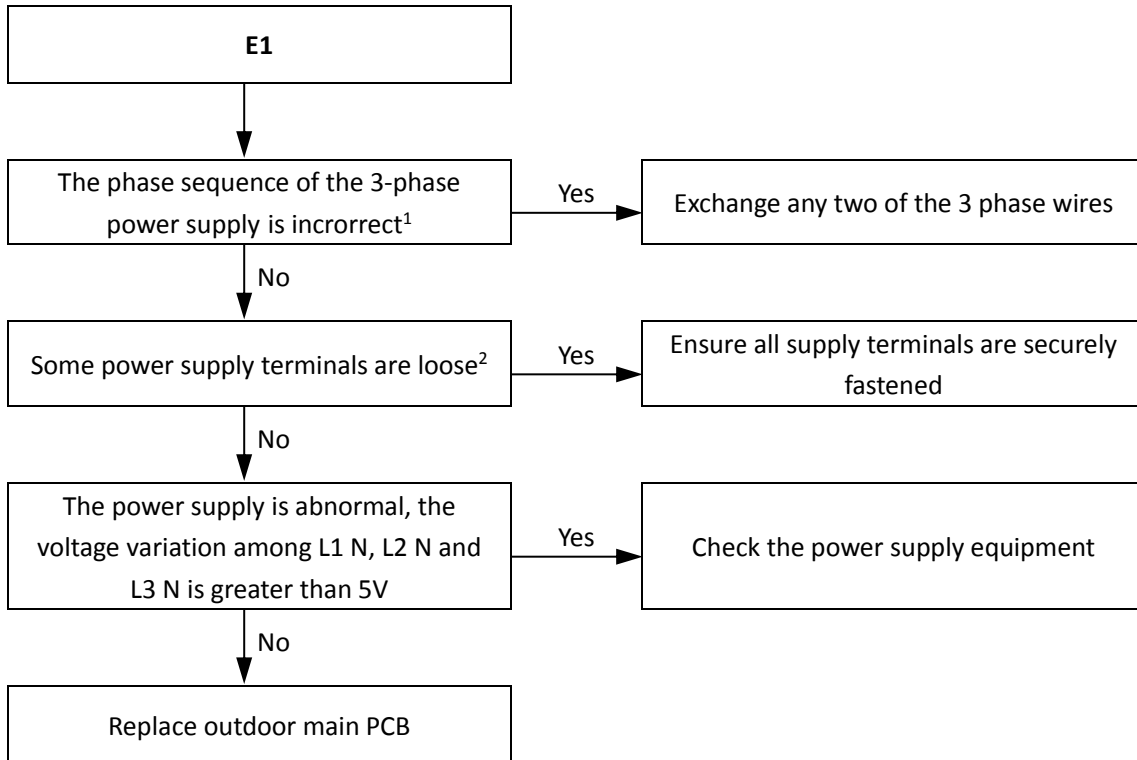

Notes:

1. The L1, L2, L3 terminals of the 3-phase power supply should match compressor phase sequence requirements. If the phase sequence is inverted, the compressor will operate inversely.
2. Loose power supply terminals can cause the compressor to operate abnormally and compressor current to be very large.

2.3 E2: Communication error between indoor and outdoor unit

2.3.1 Digital display output



2.3.2 Description

- Communication error between indoor and outdoor unit.
- The system stops running.
- Error code is displayed on the outdoor unit PCB.

2.3.3 Trigger / recover condition

- Trigger condition: Indoor units and the outdoor unit cannot communicate for 2 minutes after the system is powered on for 20 minutes.
- Recover condition: Communication go back to normal.
- Reset method: Resume automatically.

2.3.4 Possible causes

- Communication wires between indoor and outdoor units not connected properly.
- Indoor unit power supply abnormal.
- Loosened wiring within electric control box.
- Interference from high voltage wires or other sources of electromagnetic radiation.
- Communication wire too long.
- Damaged main PCB or electric control box communication terminals block.

2.3.5 Procedure

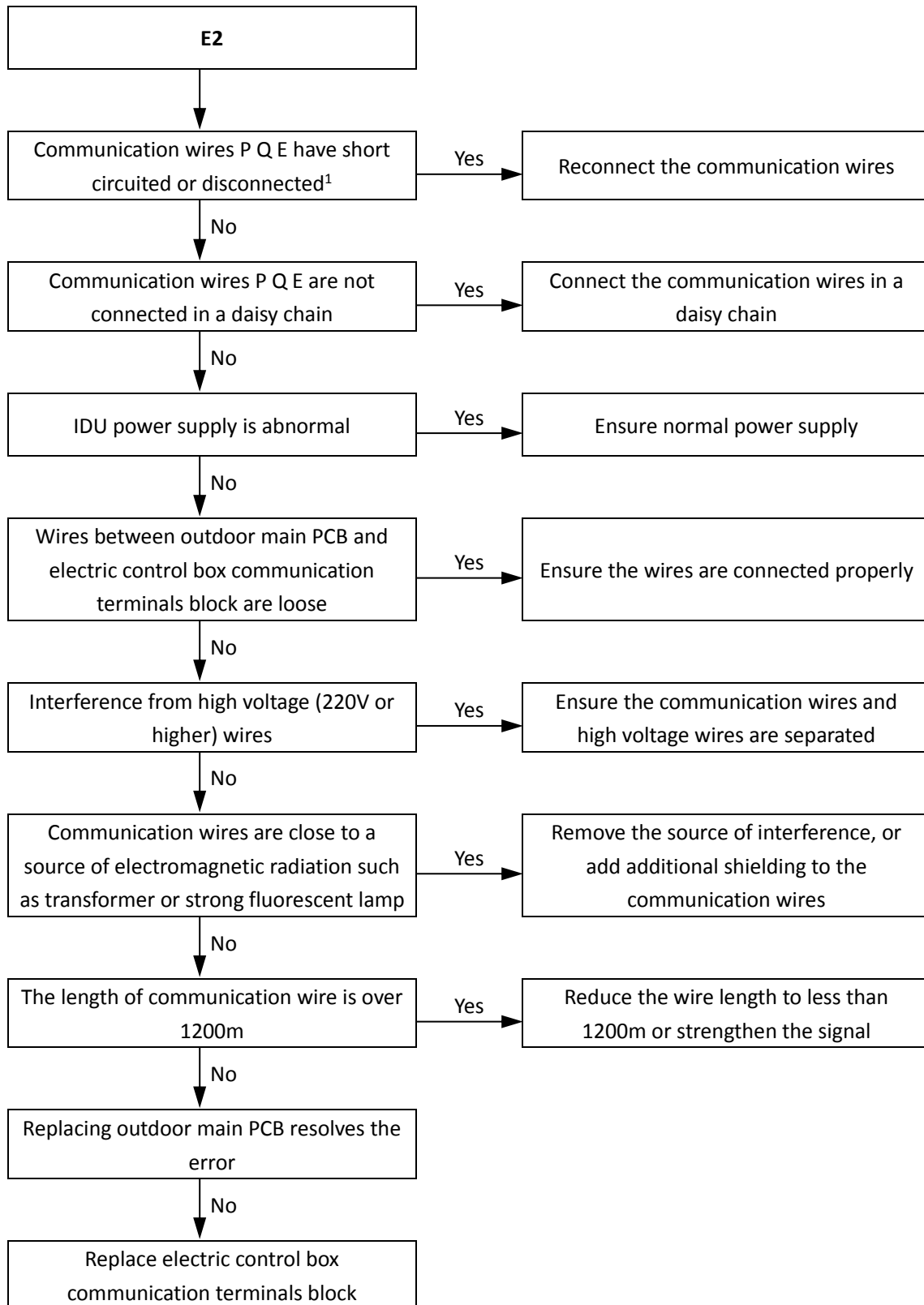

Notes:

1. Measure the resistance among P, Q and E. The normal resistance between P and Q is 120Ω, between P and E is infinite, between Q and E is infinite.

2.4 E4: Temperature sensor (T3/T4) error

2.4.1 Digital display output



2.4.2 Description

- Outdoor heat exchanger temperature sensor (T3) error or outdoor ambient temperature sensor (T4) error.
- The system stops running.
- Error code is displayed on the outdoor unit PCB.

2.4.3 Trigger / recover condition

- Trigger condition: The main control board cannot receive the feedback signal of temperature sensor T3 or T4.
- Recover condition: The main control board can receive the feedback signal of temperature sensor T3 or T4.
- Reset method: Resume automatically.

2.4.4 Possible causes

- Temperature sensor not connected properly or has malfunctioned.
- Damaged main PCB.

2.4.5 Procedure

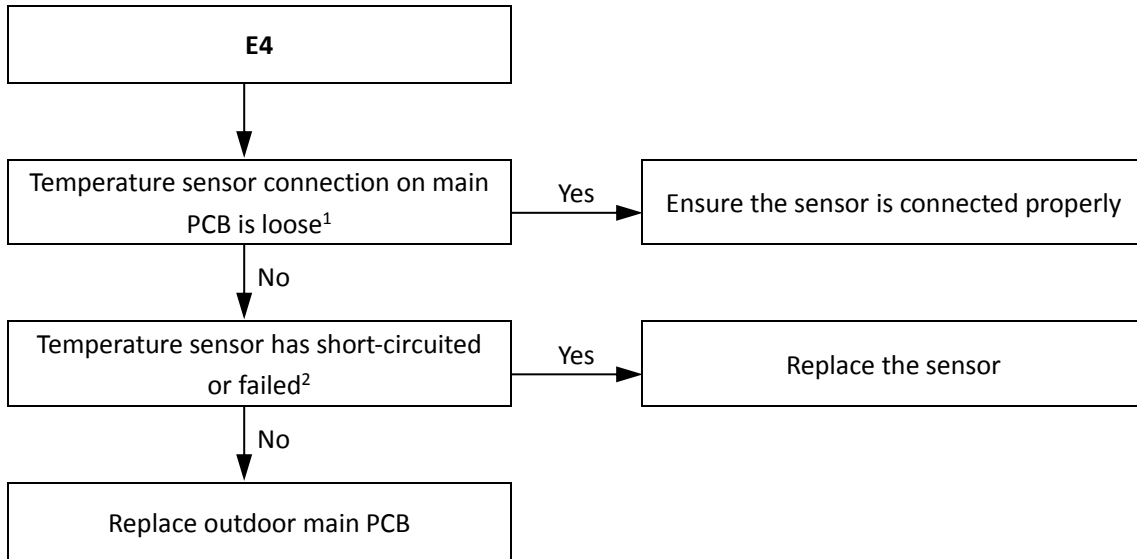

Notes:

1. Outdoor ambient temperature sensor (T4) and heat exchanger temperature sensor (T3) connection is port CN9 on the main PCB (labeled 10 in Figure 5-2.1 in Part 5, 2.1 "Ports").
2. Measure sensor resistance. If the resistance is too low, the sensor has short-circuited. If the resistance is not consistent with the sensor's resistance characteristics table, the sensor has failed. Refer to Table 6-3.1 in Part 6, 3.1 "Temperature Sensor Resistance Characteristics".

2.5 E5: Abnormal power supply voltage

2.5.1 Digital display output



2.5.2 Description

- Abnormal power supply voltage.
- The system stops running.
- Error code is displayed on the outdoor unit PCB.

2.5.3 Trigger / recover condition

- Trigger condition: Outdoor unit power supply phase voltage < 172V.
- Recover condition: Outdoor unit power supply phase voltage is > 265V.
- Reset method: Resume automatically.

2.5.4 Possible causes

- Outdoor unit power supply voltage is abnormal or a phase is missing.
- Loosened wiring within electric control box.
- High voltage circuit error.
- Main PCB damaged.

2.5.5 Procedure

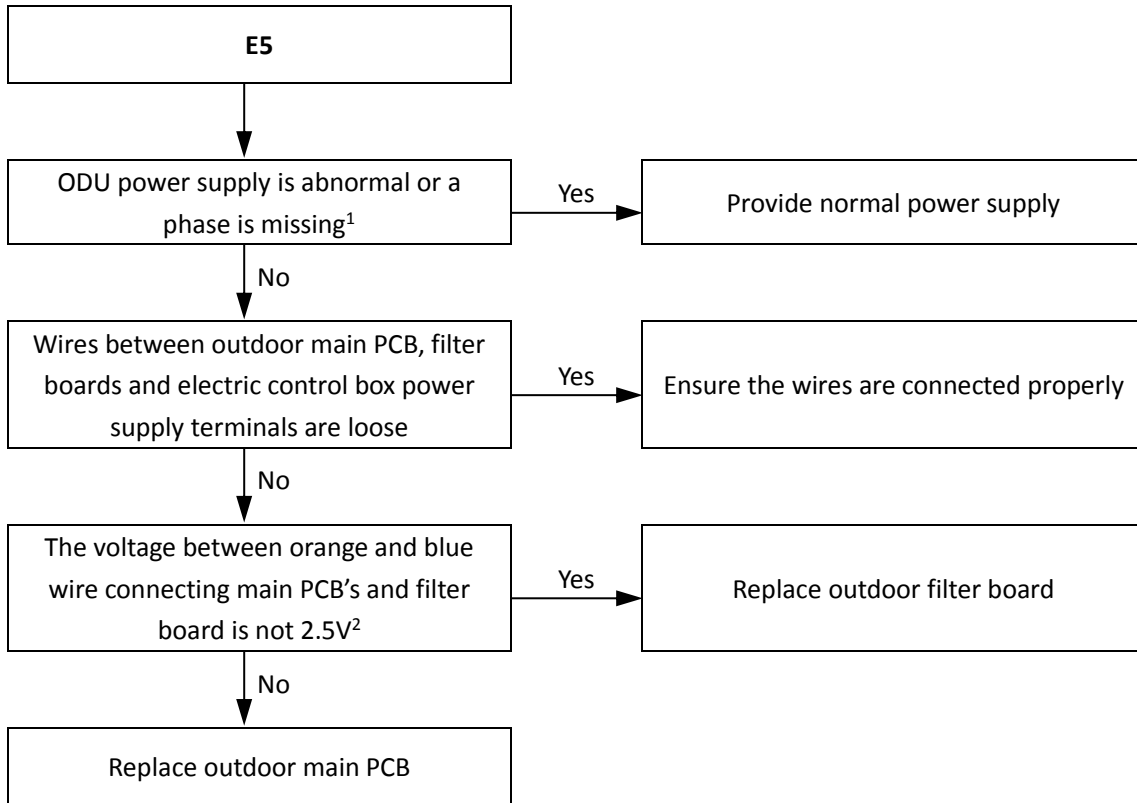

Notes:

1. The normal voltage between L1 and N, L2 and N, and L3 and N is 172-265V.
2. Control port of filter board is CN4 on the main PCB (labeled 3 in Figure 5-2.1 in Part 5, 2.1 "Ports").

2.6 E6, Eb: DC fan motor error

2.6.1 Digital display output

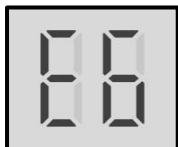

2.6.2 Description

- DC fan motor error.
- The system stops running.
- Error code is displayed on the outdoor unit PCB.

2.6.3 Trigger / recover condition

- Trigger condition:
 - For E6 protection: Actual fan speed is < 120 rps more than 20S or the actual fan speed differs from target speed by more 200rps for more than 3 minutes.
 - For Eb protection: E6 protection appears six times in 60 minutes.
- Recover condition: Actual fan speed is > 120 rps and the actual fan speed differs from target speed less than 200rps.
- Reset method: Resume automatically.
 - For E6 protection: Resume automatically.
 - For Eb protection: Manually restart.

2.6.4 Possible causes

- Loosened wiring within electric control box.
- DC fan motor damaged.
- Filter board damaged.
- Main PCB damaged.

2.6.5 Procedure

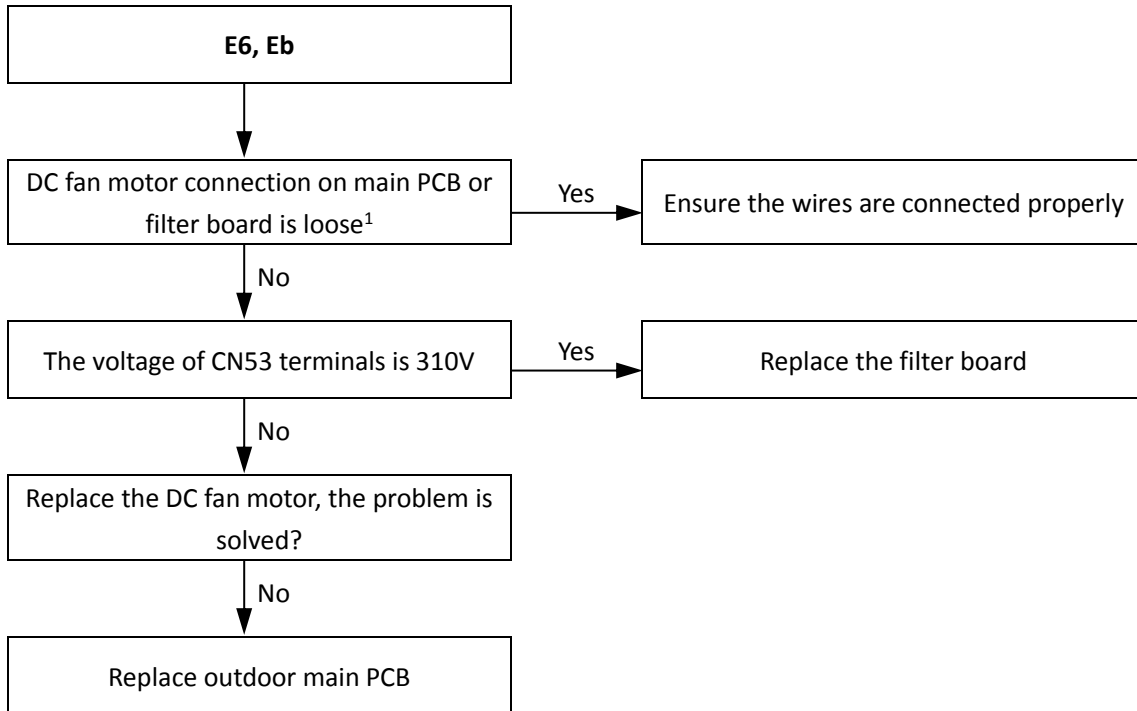

Notes:

- DC fan motor connections on main PCB are ports CN107, CN109 (labeled 14 in Figure 5-2.1 in Part 5, 2.1 "Ports") and CN53 (labeled 13 in Figure 5-2.1 in Part 5, 2.1 "Ports"). DC fan motor connection on filter board is ports CN212 (labeled 2 in Figure 5-3.2 in Part 5, 3.2 "Filter Board Ports").

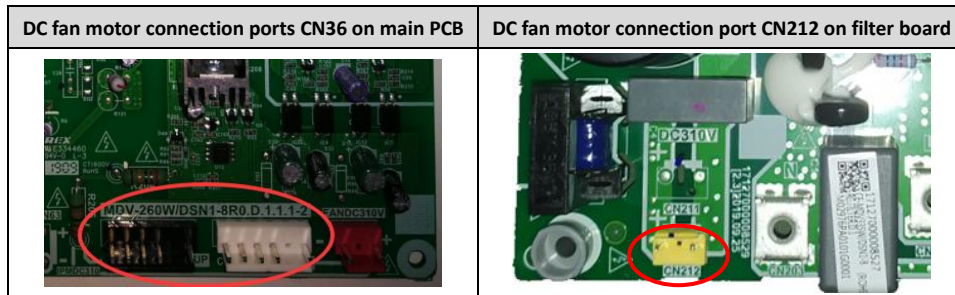

2.7 E7: Temperature sensor (T5) error

2.7.1 Digital display output



2.7.2 Description

- A compressor discharge pipe temperature sensor (T5) error.
- The system stops running.
- Error code is displayed on the outdoor unit PCB.

2.7.3 Trigger / recover condition

- Trigger condition: Discharge temperature < 15°C for 2 minutes after compressor startup for 10 minutes.
- Recover condition: Discharge temperature go back to normal.
- Reset method: Manually restart.

2.7.4 Possible causes

- Temperature sensor not connected properly or has malfunctioned.
- Damaged main PCB.

2.7.5 Procedure

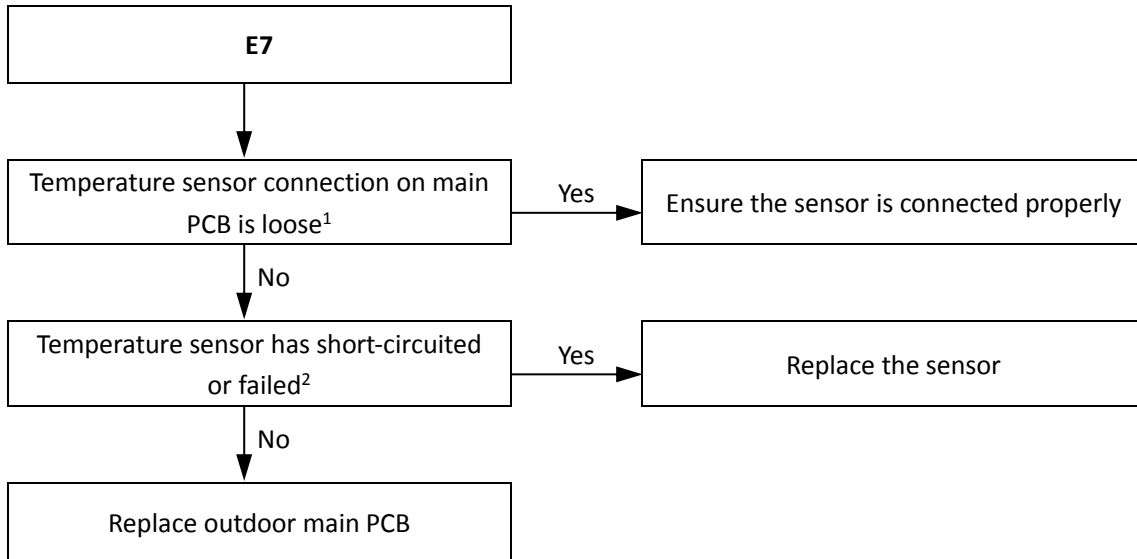

Notes:

1. Compressor discharge pipe temperature sensor connection is port CN5 on the main PCB (labeled 6 in Figure 5-2.1 in Part 5, 2.1 "Ports").
2. Measure sensor resistance. If the resistance is too low, the sensor has short-circuited. If the resistance is not consistent with the sensor's resistance characteristics table, the sensor has failed. Refer to Table 6-3.2 in Part 6, 3.1 "Temperature Sensor Resistance Characteristics".

2.8 EH: Outdoor refrigerant cooling pipe temperature sensor (TL) error

2.8.1 Digital display output



2.8.2 Description

- An outdoor refrigerant cooling pipe temperature sensor (TL) error.
- The system stops running.
- Error code is displayed on the outdoor unit PCB.

2.8.3 Trigger / recover condition

- Trigger condition: The main control board cannot receive the feedback signal of temperature sensor TL.
- Recover condition: The main control board can receive the feedback signal of temperature sensor TL.
- Reset method: Manually restart.

2.8.4 Possible causes

- Temperature sensor not connected properly or has malfunctioned.
- Damaged main PCB.

2.8.5 Procedure

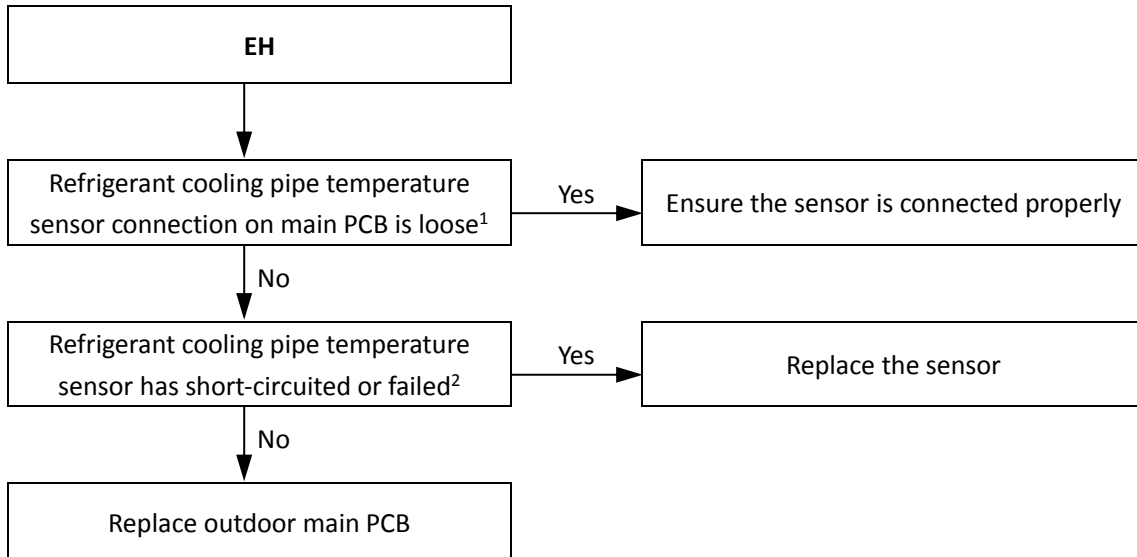

Notes:

1. Outdoor refrigerant cooling pipe temperature sensor connection is port CN24 on the main PCB (labeled 5 in Figure 5-2.1 in Part 5, 2.1 “Ports”).
2. Measure sensor resistance. If the resistance is too low, the sensor has short-circuited. If the resistance is not consistent with the sensor’s resistance characteristics table, the sensor has failed. Refer to Table 6-3.1 in Part 6, 3.1 “Temperature Sensor Resistance Characteristics”.

2.9 F1: DC bus voltage error

2.9.1 Digital display output



2.9.2 Description

- F1 indicates compressor DC bus voltage error.
- The system stops running.
- Error code is displayed on the unit with the error.

2.9.3 Trigger / recover condition

- Trigger condition: DC bus voltage < 200V continuously for 5 seconds.
- Recover condition: DC bus voltage goes back to normal.
- Reset method: Restart automatically.

2.9.4 Possible causes

- Loosened wiring of the compressor inverter module.
- Incorrect wiring of the reactor and DC bus wire.
- Abnormal power supply.
- Inverter module damaged.

2.9.5 Procedure

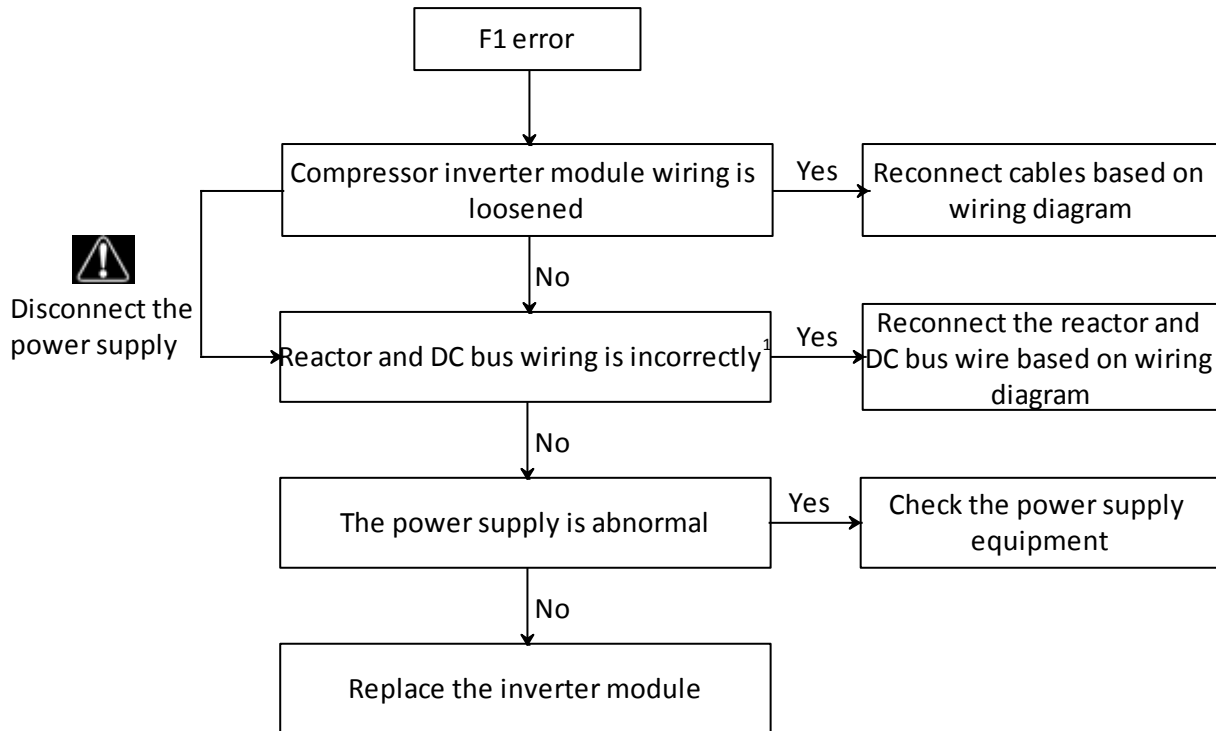

Note:

1. The normal DC voltage between terminals P and N on inverter module should be 450-650V.

Figure 6-2.1: P and N terminals on Inverter module



2.10 H0: Communication error

2.10.1 Digital display output



2.10.2 Description

- H0 indicates a communication error between the main control chip and the compressor inverter driver chip.
- The system stops running.
- Error code is displayed on the outdoor unit PCB.

2.10.3 Trigger / recover condition

- Trigger condition: Main control chip and inverter driver chip cannot communication for 2 minutes.
- Recover condition: Communication go back to normal.
- Reset method: Resume automatically.

2.10.4 Possible causes

- Loosened communication wiring from the main PCB to the inverter module.
- Main PCB damaged.
- Compressor inverter module damaged.

2.10.5 Procedure

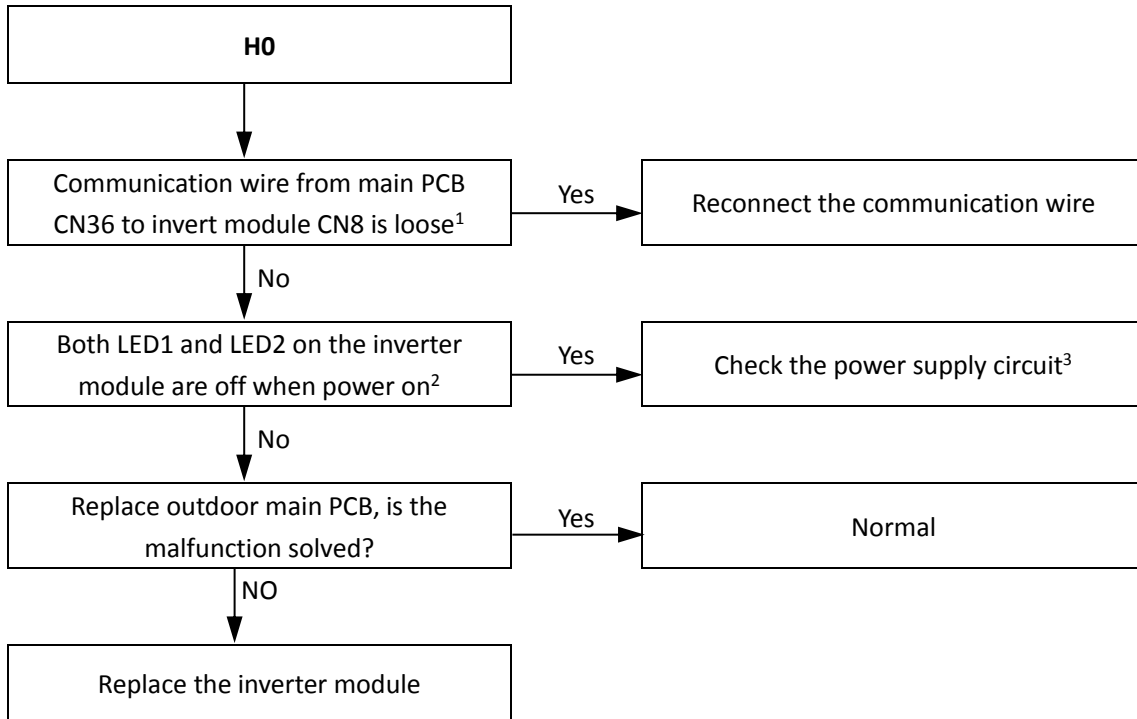

Notes:

1. Communication wire from outdoor main PCB CN36 to inverter module CN8.

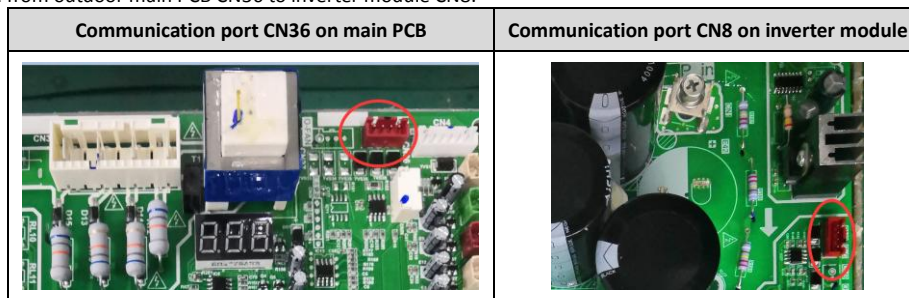

2. LED1/2 on inverter module



3. Check the power supply for the compressor inverter module, port CN211 on filter board, the normal voltage should be DC310V; Check the single phase bridge and fuse on filter board; check the connection cable from ODU main PCB port CN4 to filter board port CN8 which is 12V DC power control port.

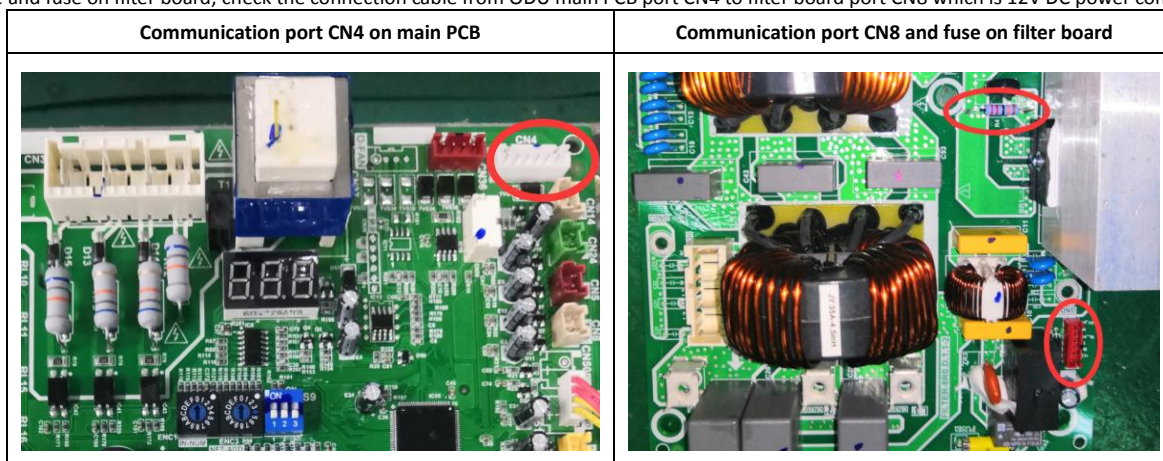

2.11 H4: Inverter module protection

2.11.1 Digital display output



2.11.2 Description

- H4 indicates compressor inverter module protection.
- The system stops running.
- Error code is displayed on the outdoor unit PCB.

2.11.3 Trigger / recover condition

- Trigger condition: Compressor appears three inverter module protections.
- Recover condition: Inverter module goes back to normal.
- Reset method: Manually restart.

2.11.4 Possible causes

- Inverter module protection.
- DC bus low or high voltage protection.
- MCE error.
- Zero speed protection.
- Phase sequence error.
- Excessive compressor frequency variation.
- Actual compressor frequency differs from target frequency.

2.11.5 Specific error codes for H4 inverter module protection

If an H4 error code is displayed, enter menu mode “n31” (refer to Part 5, 2.2.3 “menu mode”) to check the history error code to check the following specific error code: L0, L1, L2, L4, L5, L7, L8, L9.

Table 6-2.1: Specific error codes for error H4

Specific error code ¹	Content
L0	Inverter module protection
L1	DC bus low voltage protection
L2	DC bus high voltage protection
L4	MCE error
L5	Zero speed protection
L7	Phase sequence error
L8	Compressor frequency variation greater than 15Hz within one second protection
L9	Actual compressor frequency differs from target frequency by more than 15Hz protection

The specific error codes L0, L1, L2 and L4 can also be obtained from the inverter module LED indicators. If an inverter module error has occurred, LED2 is continuously on and LED1 flashes.

Figure 6-2.2: LED indicators LED1 and LED2 on inverter module

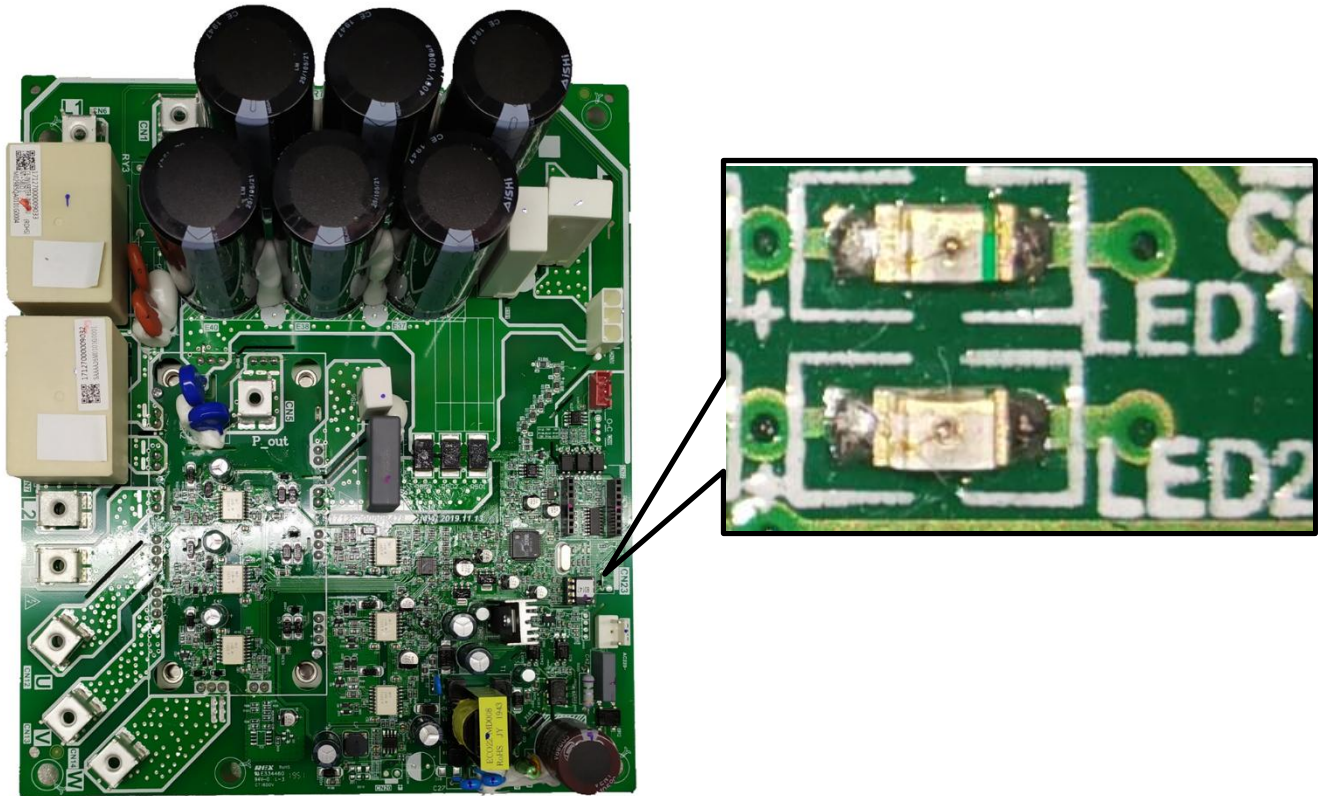
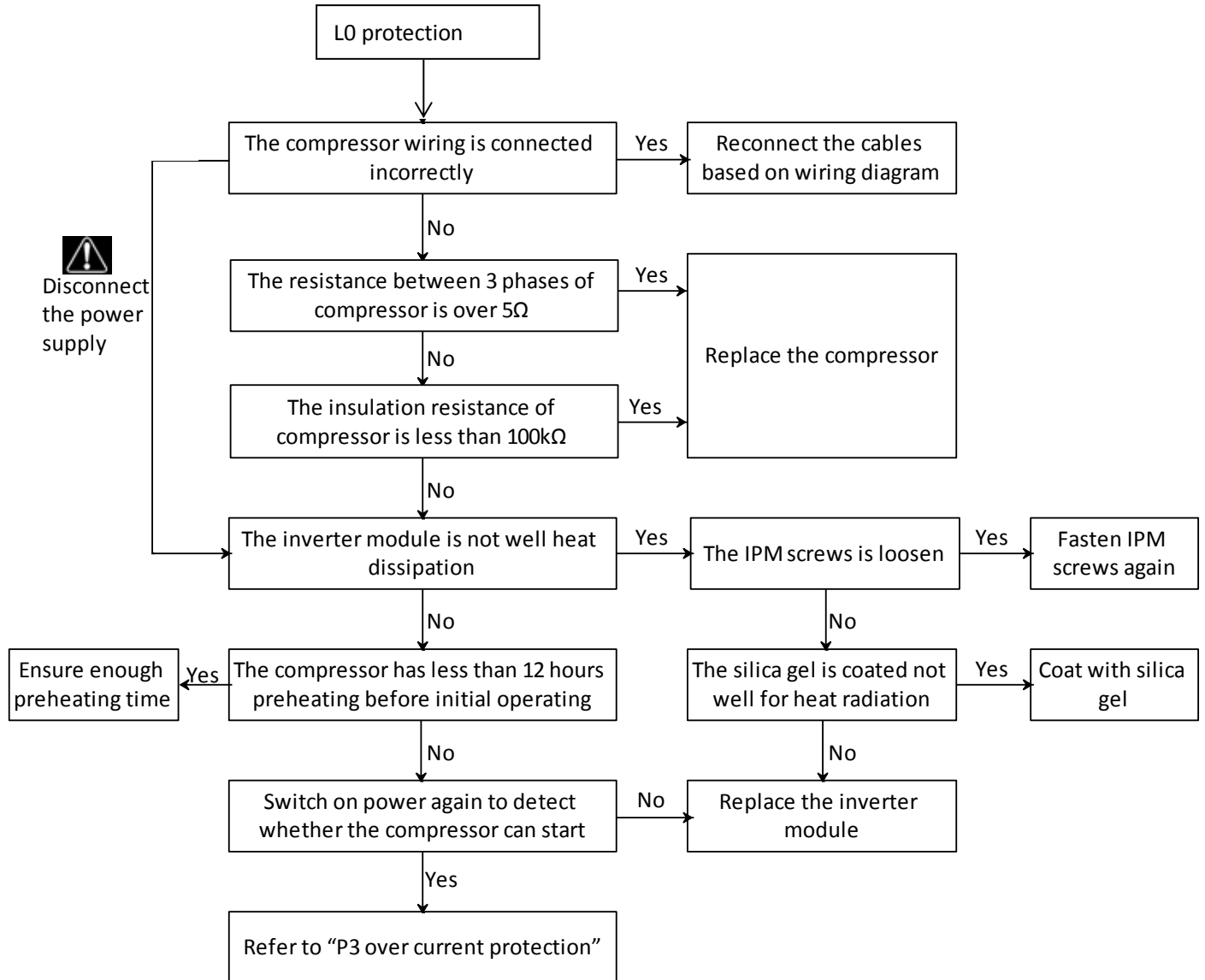

Table 2-6.2: Errors indicated on LED1

LED1 flashing pattern	Corresponding error
Flashes 8 times and stops for 1 second, then repeats	L0 - Inverter module protection
Flashes 9 times and stops for 1 second, then repeats	L1 - DC bus low voltage protection
Flashes 10 times and stops for 1 second, then repeats	L2 - DC bus high voltage protection
Flashes 12 times and stops for 1 second, then repeats	L4 - MCE error

2.11.6 L0: Inverter module protection



2.11.7 L1: DC bus low voltage protection

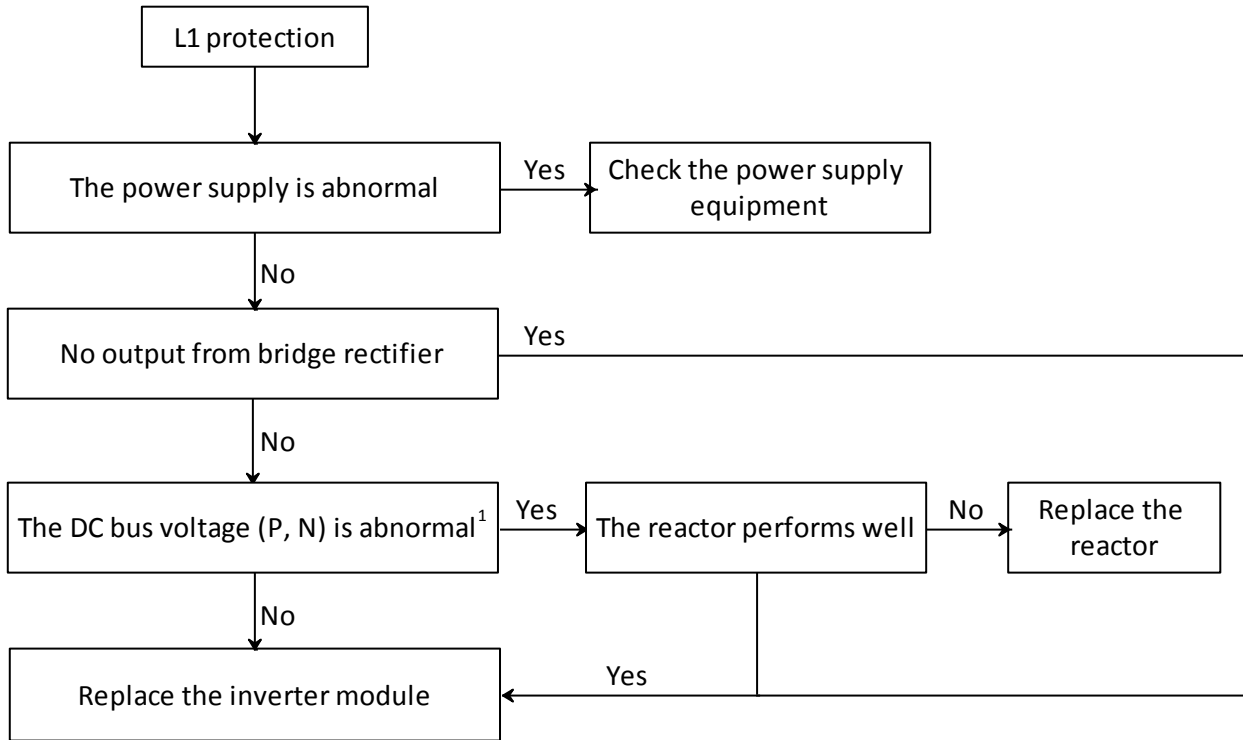

- Note:
1. The normal DC voltage between terminals P and N on inverter module should be 450-650V. When the voltage is lower than 350V, L1 protection will be appeared.

Figure 6-2.3: P and N terminals on Inverter module



2.11.8 L2: DC bus high voltage protection

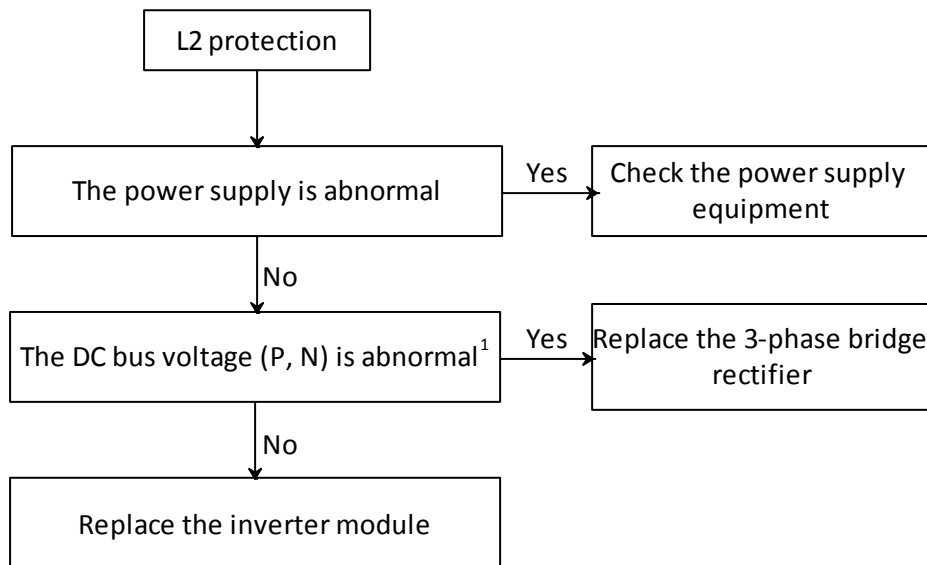

Note:

1. The normal DC voltage between terminals P and N on inverter module should be 520V. When the voltage is higher than 630V, L2 protection will be appeared.

Figure 6-2.4: P and N terminals on Inverter module



2.11.9 L4: MCE error



Disconnect the power supply

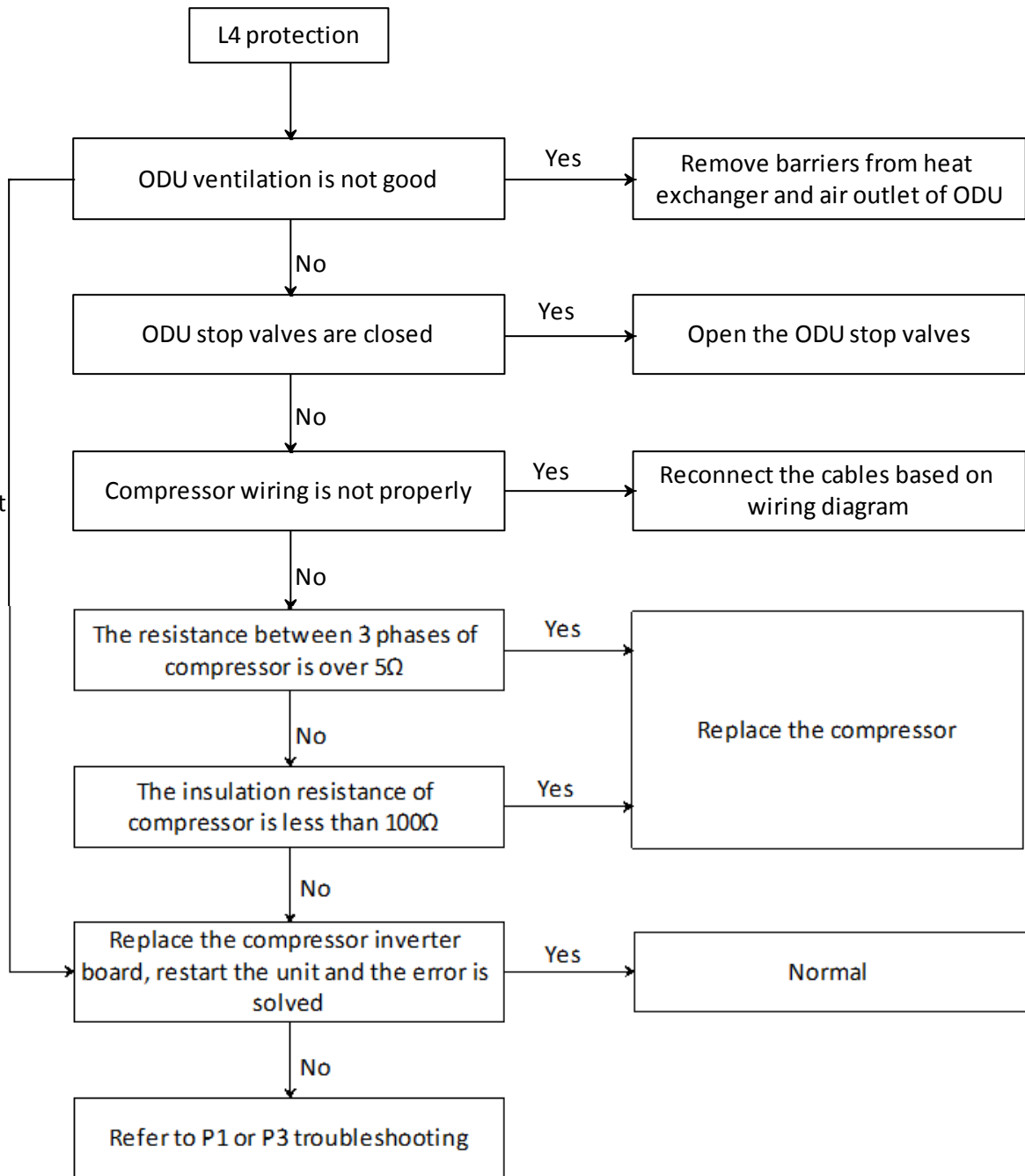

2.11.10 L5: Zero speed protection

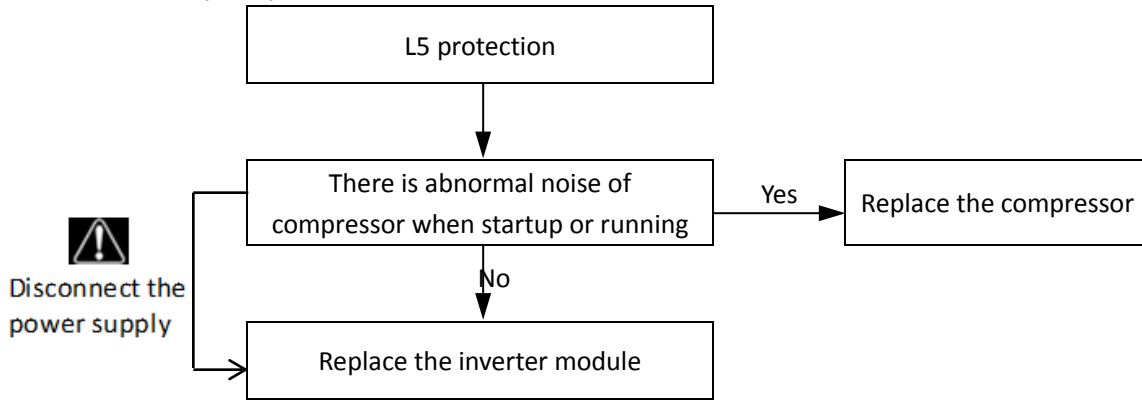

2.11.11 L7: Phase sequence error

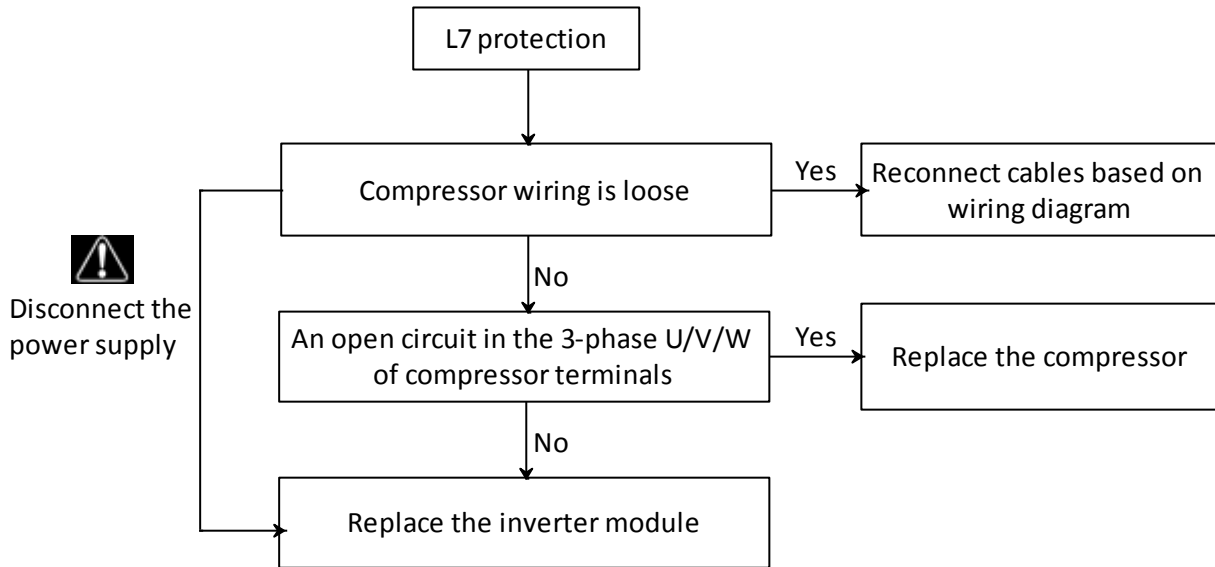

2.11.12 L8: Compressor frequency variation greater than 15Hz within one second protection

L9: Actual compressor frequency differs from target frequency by more than 15Hz protection

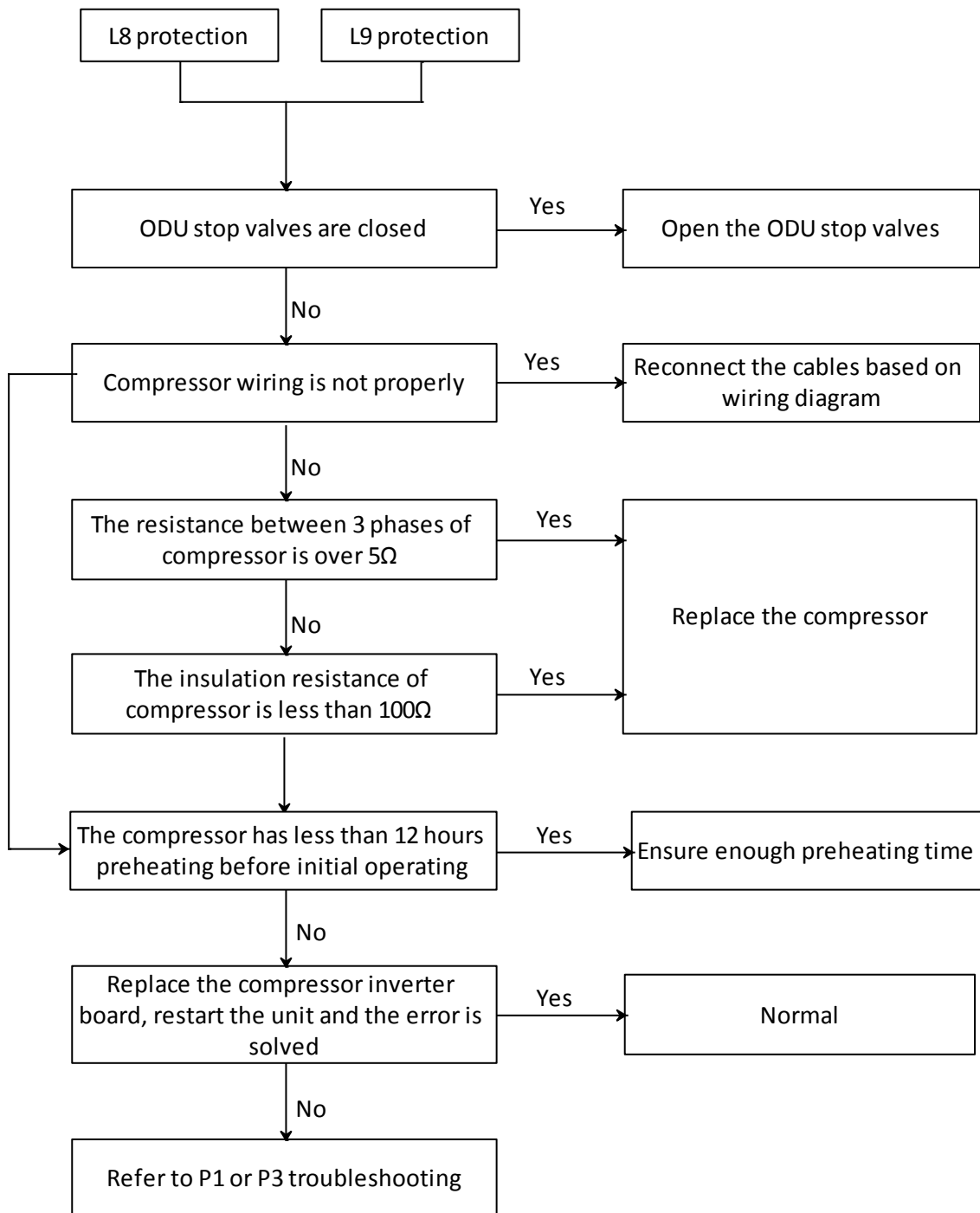

Disconnect the power supply

2.11.13 Compressor replacement procedure

Step 1: Remove faulty compressor and remove oil

- Remove the faulty compressor from the outdoor unit.
- Before removing the oil, shake the compressor so as to not allow impurities to remain settled at the bottom.
- Drain the oil out of the compressor and retain it for inspection. Normally the oil can be drained out from the compressor discharge pipe.

Figure 6-2.5: Draining oil from a compressor



Step 2: Inspect oil from faulty compressor

- The oil should be clear and transparent. Slightly yellow oil is not an indication of any problems. However, if the oil is dark, black or contains impurities, the system has problems and the oil needs to be changed. Refer to Figure 6-2.7 for further details regarding inspecting compressor oil. (If the compressor oil has been spoiled, the compressor will not be being lubricated effectively. The scroll plate, crankshaft and bearings will wear. Abrasion will lead to a larger load and higher current. More electric energy will get dissipated as heat and the temperature of the motor will become increasingly high. Finally, compressor damage or burnout will result.)

Step 3: Check oil in other compressors in the system

- If the oil drained from the faulty compressor is clean, go to Step 6.
- If the oil drained from the faulty compressor is spoiled (lightly or heavily), go to Step 4.

Step 4: Replace oil separator and accumulator

- If the oil from a compressor is spoiled (lightly or heavily), drain the oil from the oil separator and accumulator in that unit and then replace them.

Step 5: Check filters(s)

- If the oil from a compressor is spoiled (lightly or heavily), check the filter between the gas stop valve and the 4-way valve in that unit. If it is blocked, clean with nitrogen or replace.

Step 6: Replace the faulty compressor and re-fit the other compressors

- Replace the faulty compressor.
- If the oil had been spoiled and was drained from the non-faulty compressor in Step 3, use clean oil to clean them before re-fitting it into the unit. To clean, add oil into the compressor through the discharge pipe using a funnel, shake the compressor, and then drain the oil. Repeat several times and then re-fit the compressors into the units. (The discharge pipe is connected to the oil pool of the compressor by the inner oil balance pipe.)

Figure 6-2.6: Compressor piping



Step 7: Add compressor oil

- Add 2.3L of oil to each of the compressors from which oil was drained in Step 3.
- Only use FV50S oil. Different compressors require different types of oil. Using the wrong type of oil leads to various problems.
- Add additional 1.5L oil to the accumulator from which oil was drained in Step 4 such that the total amount of oil is 3.8L.

Step 8: Vacuum drying and refrigerant charging

- Once all the compressors and other components have been fully connected, vacuum dry the system and recharge refrigerant. Refer to the V4+i Engineering Data Book, Part 3.

Figure 6-2.7: Inspecting compressor oil



This oil is black - it has been carbonized

This oil is a little yellow, but is clear and transparent and the condition is acceptable

This oil is still transparent but there are impurities which may clog the filter

Cloudy or gray oil indicates abnormal system operation

This oil contains particles of copper

2.12 H7: Unmatched total number of indoor units

2.12.1 Digital display output



2.12.2 Description

- Number of indoor units detected by the outdoor unit not same as number set on main PCB.
- The system stops running.
- Error code is displayed on the outdoor unit PCB.

2.12.3 Trigger / recover condition

- Trigger condition: At least one indoor unit cannot be detected by the outdoor unit for more than 20 minutes for the first time powered on or at least one indoor unit cannot be detected by the outdoor unit for more than 3 minutes.
- Recover condition: Number of indoor units detected by the outdoor unit is same as number set on main PCB.
- Reset method: Resume automatically.

2.12.4 Possible causes

- Number of indoor units set on main PCB not same as actual number of indoor units.
- Some indoor units are powered off.
- Communication wires between indoor and outdoor units not connected properly.
- Indoor unit PCB damaged.
- Indoor unit without address or indoor unit address duplicated.
- Main PCB damaged.

2.12.5 Procedure

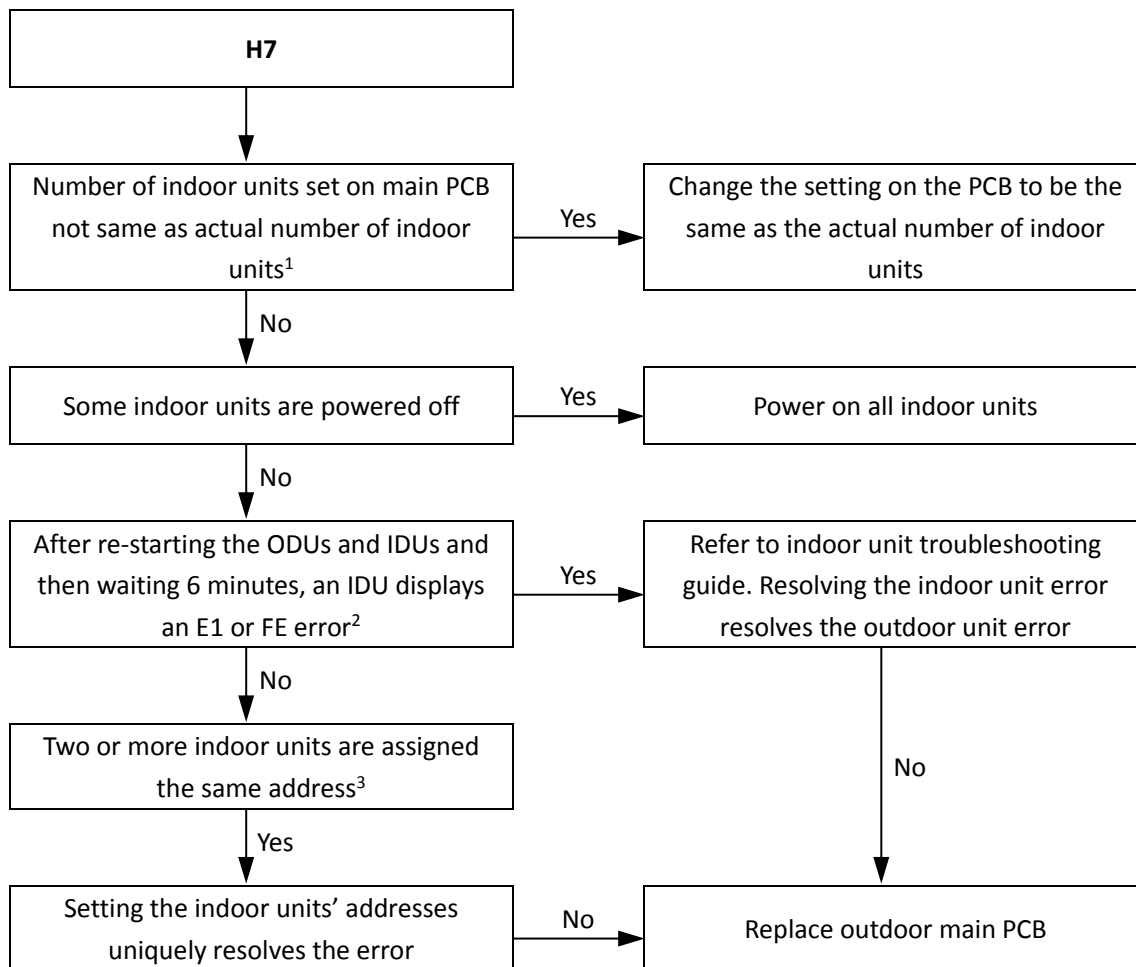

Notes:

1. The number of indoor units can be set on switches ENC1 and S9-3 on the main PCB.
2. Indoor unit error code E1 indicates a communication error between indoor and outdoor unit. Indoor unit error code FE indicates that an indoor unit has not been assigned an address.
3. Indoor unit addresses can be checked and manually assigned using indoor unit remote/wired controllers. Alternatively, indoor unit addresses can be automatically assigned by the outdoor unit.

2.13 H8: High pressure sensor error

2.13.1 Digital display output



2.13.2 Description

- High pressure sensor error.
- The system stops running.
- Error code is displayed on the unit with the error.

2.13.3 Trigger / recover condition

- Trigger condition: Discharge pressure \leq 0.3MPa.
- Recover condition: Discharge pressure $>$ 0.3MPa.
- Reset method: Resume automatically.

2.13.4 Possible causes

- Pressure sensor not connected properly or has malfunctioned.
- Insufficient refrigerant.
- Low pressure side blockage.
- Poor evaporator heat exchange.
- Main PCB damaged.

2.13.5 Procedure

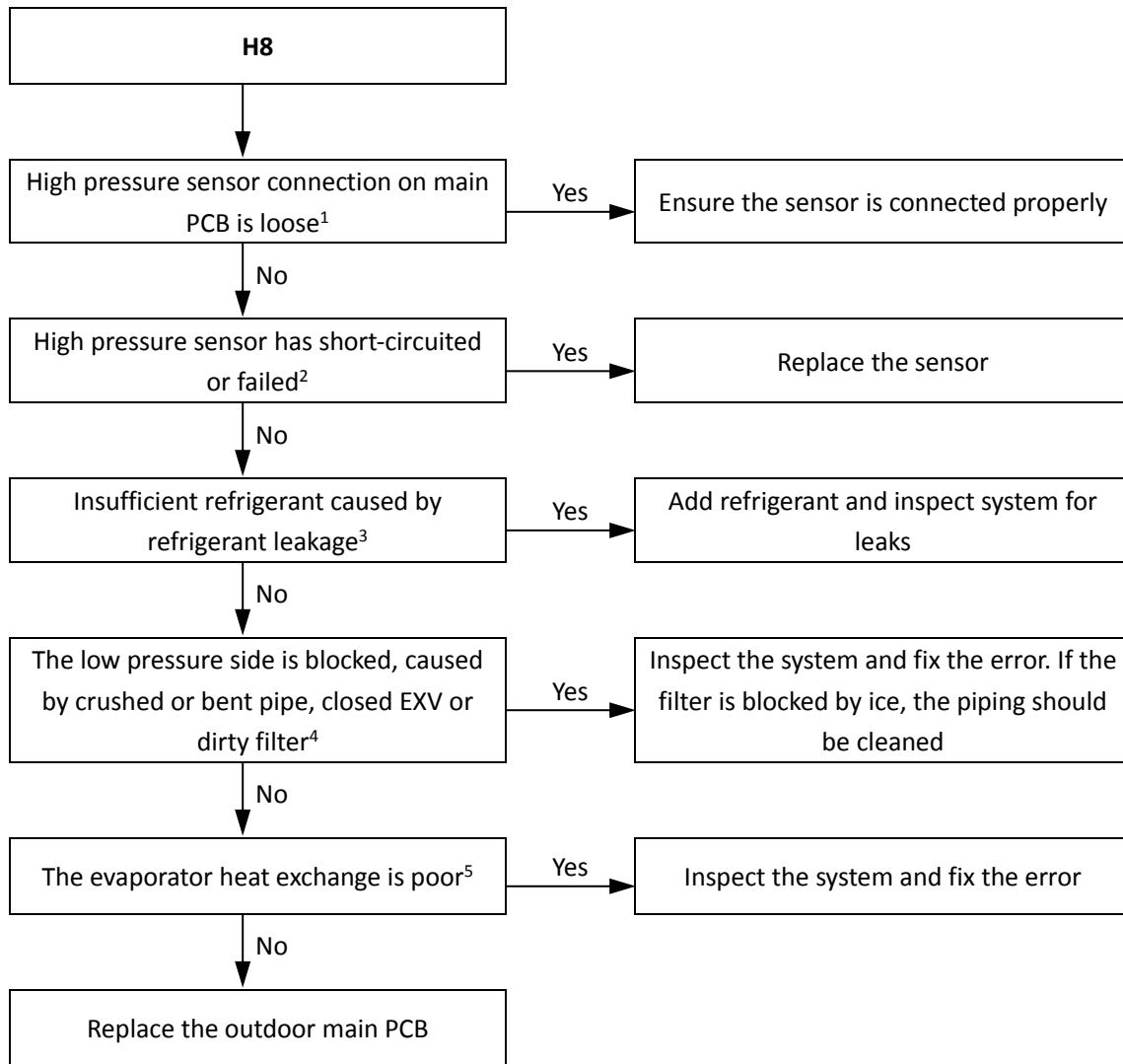

Notes:

1. High pressure sensor connection is port CN12 on the main PCB (labeled 8 in Figure 5-2.1 in Part 5, 2.1 "Ports").
2. Measure the resistance among the three terminals of the pressure sensor. If the resistance is of the order of mega Ohms or infinite, the pressure sensor has failed.
3. An insufficiency of refrigerant causes compressor discharge temperature to be higher than normal, discharge and suction pressures to be lower than normal and compressor current to be lower than normal, and may cause frosting to occur on the suction pipe. These issues disappear once sufficient refrigerant has been charged into the system. For normal system parameters refer to Table 6-3.4 and 6-3.5 in Part 6, 3.2 "Normal Operating Parameters of Refrigerant System".
4. A low pressure side blockage causes compressor discharge temperature to be higher than normal, suction pressure to be lower than normal and compressor current to be lower than normal, and may cause frosting to occur on the suction pipe. For normal system parameters refer to Table 6-3.4 and 6-3.5 in Part 6, 3.2 "Normal Operating Parameters of Refrigerant System".
5. In cooling mode check indoor heat exchangers, fans and air outlets for dirt/blockages. In heating mode check outdoor heat exchangers, fans and air outlets for dirt/blockages.

2.14 P1: Discharge pipe high pressure protection

2.14.1 Digital display output



2.14.2 Description

- Discharge pipe high pressure protection.
- The system stops running.
- Error code is displayed on the outdoor unit PCB.

2.14.3 Trigger / recover condition

- Trigger condition: Discharge pressure ≥ 4.4 MPa.
- Recover condition: Discharge pressure ≤ 3.2 MPa.
- Reset method: Resume automatically.

2.14.4 Possible causes

- Outdoor unit stop valves are closed.
- Pressure sensor/switch not connected properly or has malfunctioned.
- Excess refrigerant.
- System contains air or nitrogen.
- High pressure side blockage.
- Poor condenser heat exchange.
- Main PCB damaged.

2.14.5 Procedure

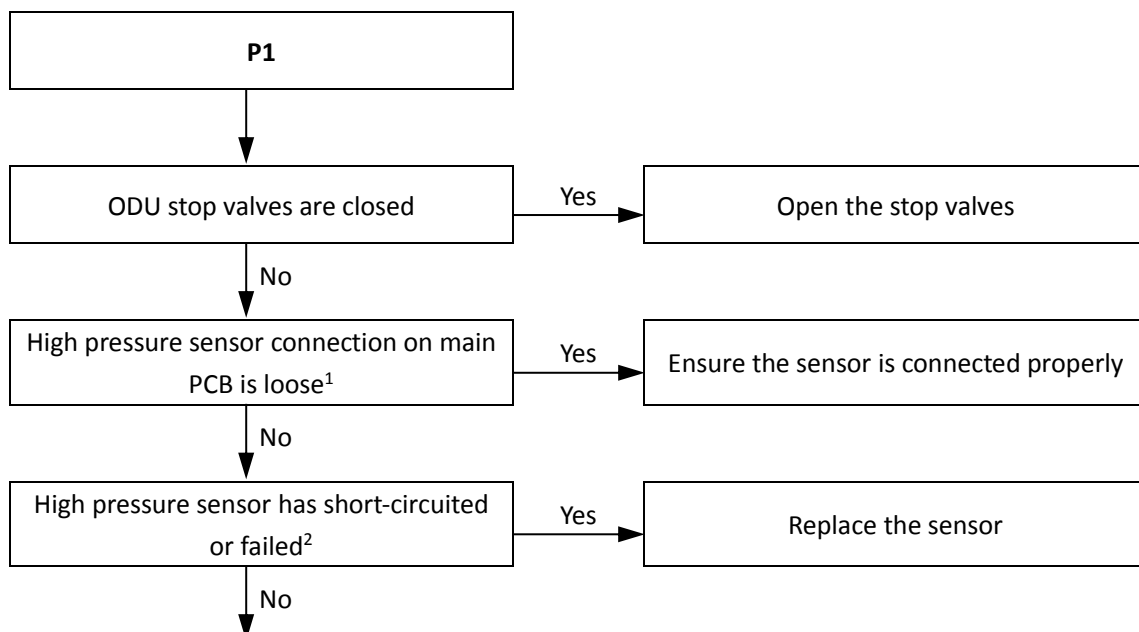

Flowchart continued on next page ...

... flowchart continued from previous page

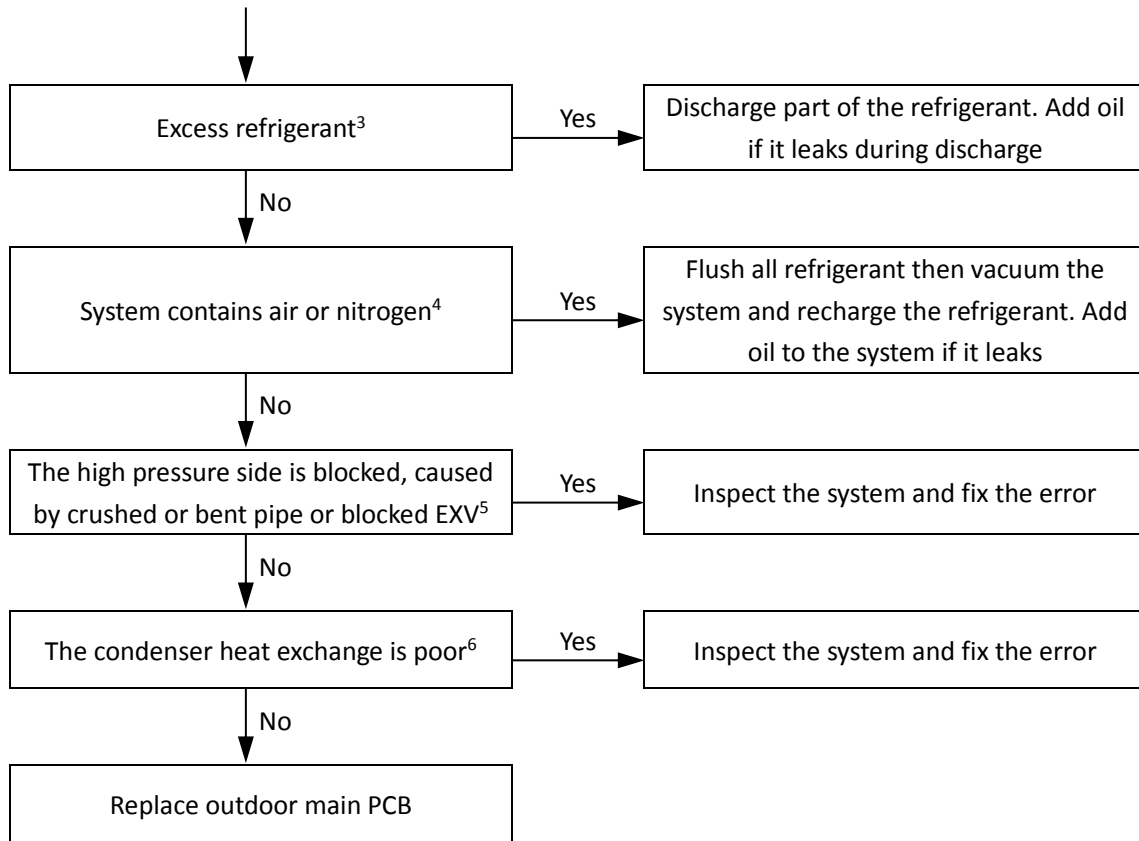

Notes:

1. The high pressure sensor connection is port CN12 on the main PCB (labeled 8 in Figure 5-2.1 in Part 5, 2.1 "Ports").
2. Measure the resistance among the three terminals of the pressure sensor. If the resistance is of the order of mega Ohms or infinite, the pressure sensor has failed.
3. Excess refrigerant causes discharge temperature to be lower than normal, discharge pressure to be higher than normal and suction pressure to be higher than normal. For normal system parameters refer to Table 6-3.4 and 6-3.5 in Part 6, 3.2 "Normal Operating Parameters of Refrigerant System".
4. Air or nitrogen in the system causes discharge temperature to be higher than normal, discharge pressure to be higher than normal, compressor current to be higher than normal, abnormal compressor noise and an unsteady pressure meter reading. For normal system parameters refer to Table 6-3.4 and 6-3.5 in Part 6, 3.2 "Normal Operating Parameters of Refrigerant System".
5. High pressure side blockage causes discharge temperature to be higher than normal, discharge pressure to be higher than normal and suction pressure to be lower than normal. For normal system parameters refer to Table 6-3.4 and 6-3.5 in Part 6, 3.2 "Normal Operating Parameters of Refrigerant System".
6. In cooling mode check outdoor heat exchangers, fans and air outlets for dirt/blockages. In heating mode check indoor heat exchangers, fans and air outlets for dirt/blockages.

2.15 P2, H5: Suction pipe low pressure protection

2.15.1 Digital display output



2.15.2 Description

- Suction pipe low pressure protection.
- The system stops running.
- Error code is displayed on outdoor unit PCB.

2.15.3 Trigger / recover condition

- Trigger condition:
 - For P2 protection: Suction pressure $\leq 0.05\text{MPa}$.
 - For H5 protection: P2 protection appears three times in 30 minutes.
- Recover condition: Suction pressure $\geq 0.15\text{MPa}$.
- Reset method:
 - For P2 protection: Resume automatically.
 - For H5 protection: Manually restart.

2.15.4 Possible causes

- Outdoor unit stop valves are closed.
- Insufficient refrigerant.
- Low pressure side blockage.
- Poor evaporator heat exchange.
- Main PCB damaged.

2.15.5 Procedure

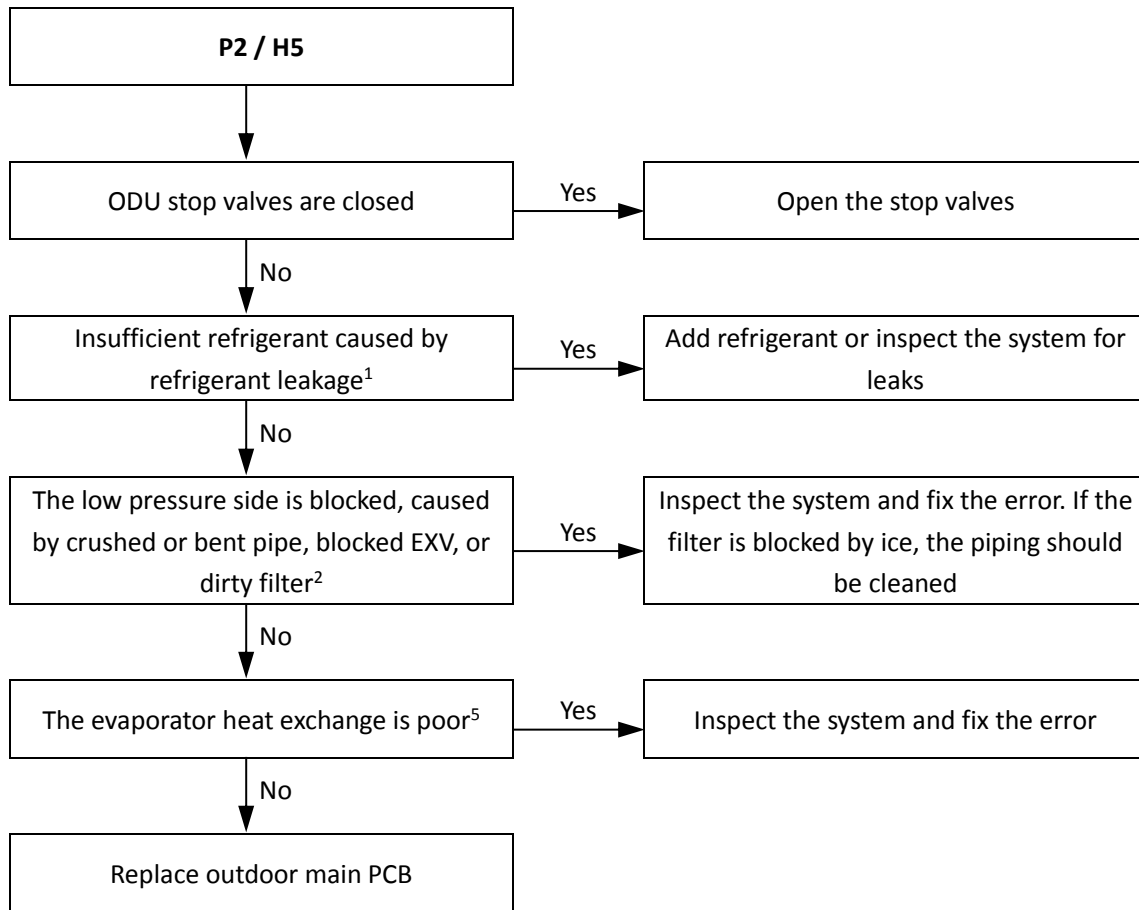

Notes:

1. An insufficiency of refrigerant causes compressor discharge temperature to be higher than normal, discharge and suction pressures to be lower than normal and compressor current to be lower than normal, and may cause frosting to occur on the suction pipe. These issues disappear once sufficient refrigerant has been charged into the system. For normal system parameters refer to Table 6-3.4 and 6-3.5 in Part 6, 3.2 "Normal Operating Parameters of Refrigerant System".
2. A low pressure side blockage causes compressor discharge temperature to be higher than normal, suction pressure to be lower than normal and compressor current to be lower than normal, and may cause frosting to occur on the suction pipe. For normal system parameters refer to Table 6-3.4 and 6-3.5 in Part 6, 3.2 "Normal Operating Parameters of Refrigerant System".
3. In cooling mode check indoor heat exchangers, fans and air outlets for dirt/blockages. In heating mode check outdoor heat exchangers, fans and air outlets for dirt/blockages.

2.16 P3: Compressor current protection

2.16.1 Digital display output



2.16.2 Description

- P3 indicates current protection on compressor.
- The system stops running.
- Error code is displayed on the outdoor unit PCB.

2.16.3 Trigger / recover condition

- Trigger condition: Current of compressor LNB65FAGMC \geq 29A.
- Recover condition: Current of compressor LNB65FAGMC $<$ 29A.
- Reset method: Resume automatically.

2.16.4 Possible causes

- Outdoor unit stop valves are closed.
- Indoor load too large.
- Power supply abnormal.
- Sudden interruption of power to IDUs.
- Excess refrigerant.
- System contains air or nitrogen.
- Poor condenser heat exchange.
- High pressure side blockage.
- Inverter module damaged.
- Compressor damaged.
- Main PCB damaged.

2.16.5 Procedure

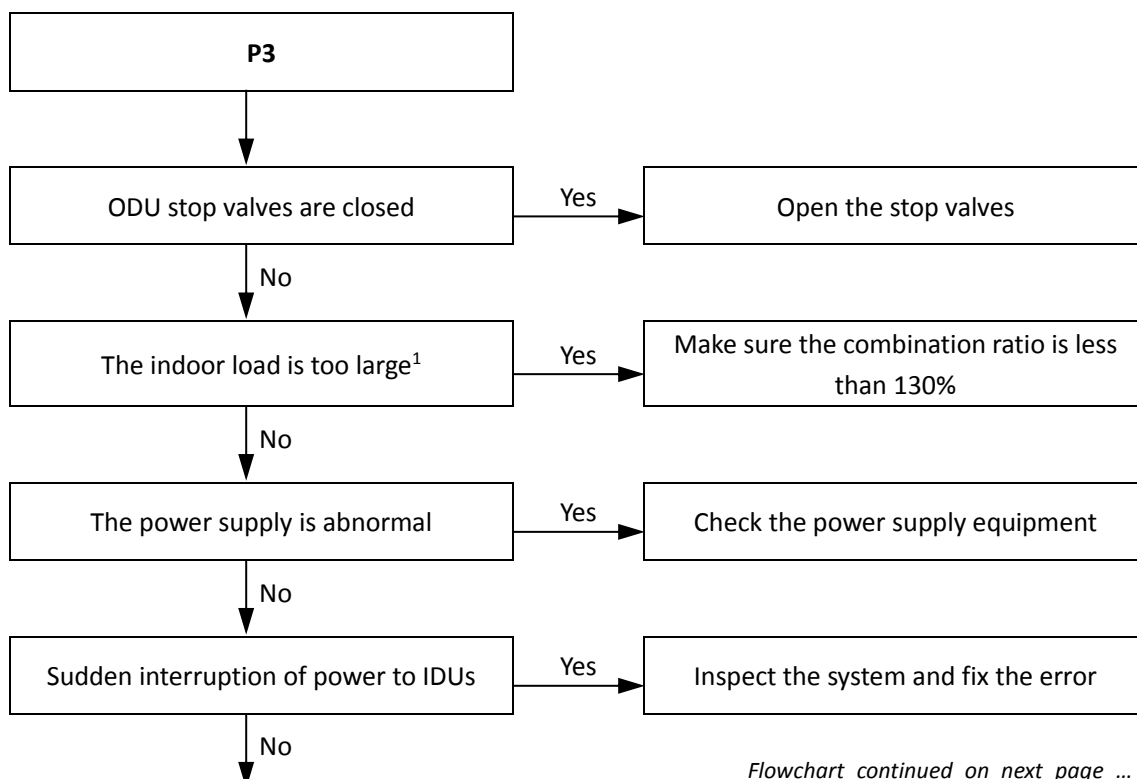

... flowchart continued from previous page

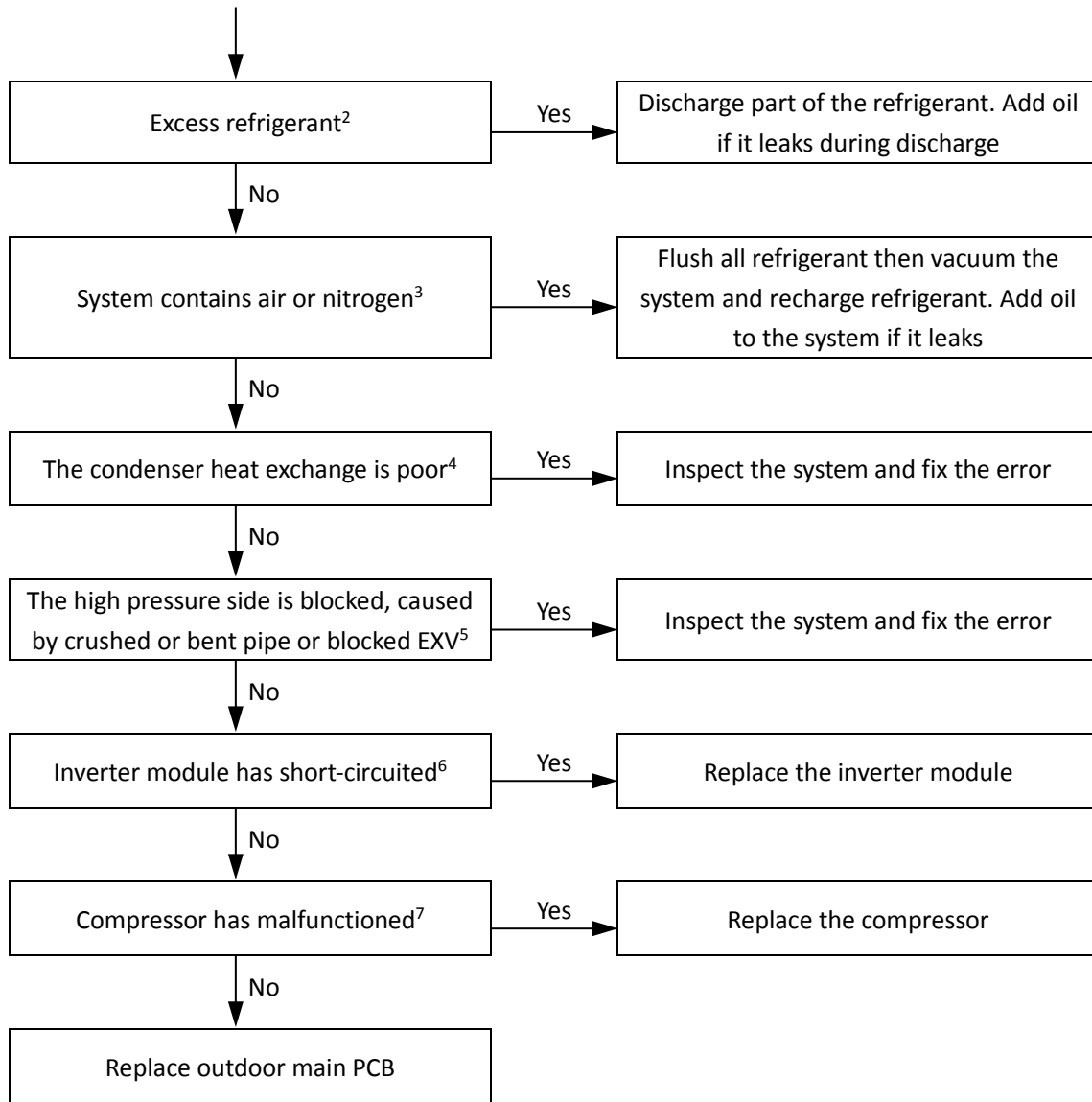

Notes:

1. An indoor load that is too large causes suction and discharge temperatures to be higher than normal. For normal system parameters refer to Table 6-3.4 and 6-3.5 in Part 6, 3.2 "Normal Operating Parameters of Refrigerant System".
2. Excess refrigerant causes discharge temperature to be lower than normal, discharge pressure to be higher than normal and suction pressure to be higher than normal. For normal system parameters refer to Table 6-3.4 and 6-3.5 in Part 6, 3.2 "Normal Operating Parameters of Refrigerant System".
3. Air or nitrogen in the system causes discharge temperature to be higher than normal, discharge pressure to be higher than normal, compressor current to be higher than normal, abnormal compressor noise and an unsteady pressure meter reading. For normal system parameters refer to Table 6-3.4 and 6-3.5 in Part 6, 3.2 "Normal Operating Parameters of Refrigerant System".
4. In cooling mode check outdoor heat exchangers, fans and air outlets for dirt/blockages. In heating mode check indoor heat exchangers, fans and air outlets for dirt/blockages.
5. High pressure side blockage causes discharge temperature to be higher than normal, discharge pressure to be higher than normal and suction pressure to be lower than normal. For normal system parameters refer to Table 6-3.4 and 6-3.5 in Part 6, 3.2 "Normal Operating Parameters of Refrigerant System".
6. Set a multi-meter to buzzer mode and test any two terminals of P N U V W of the inverter module. If the buzzer sounds, the inverter module has short-circuited.
7. The normal resistances of the inverter compressor are 0.7-1.5Ω among U V W and infinite between each of U V W and ground. If any of the resistances differ from these specifications, the compressor has malfunctioned.

2.17 P4: Discharge temperature protection

2.17.1 Digital display output



2.17.2 Description

- Discharge temperature protection.
- The system stops running.
- Error code is displayed on the unit with the error.

2.17.3 Trigger / recover condition

- Trigger condition:
Discharge temperature (T5) > 110°C.
- Recover condition: Discharge temperature (T5) < 85 °C.
- Reset method:
Resume automatically.

2.17.4 Possible causes

- Outdoor unit stop valves are closed.
- Temperature sensor/switch not connected properly or has malfunctioned.
- Insufficient refrigerant.
- System blockage.
- Indoor load too large.
- System contains air or nitrogen.
- Poor condenser heat exchange.
- Main PCB damaged.

2.17.5 Procedure

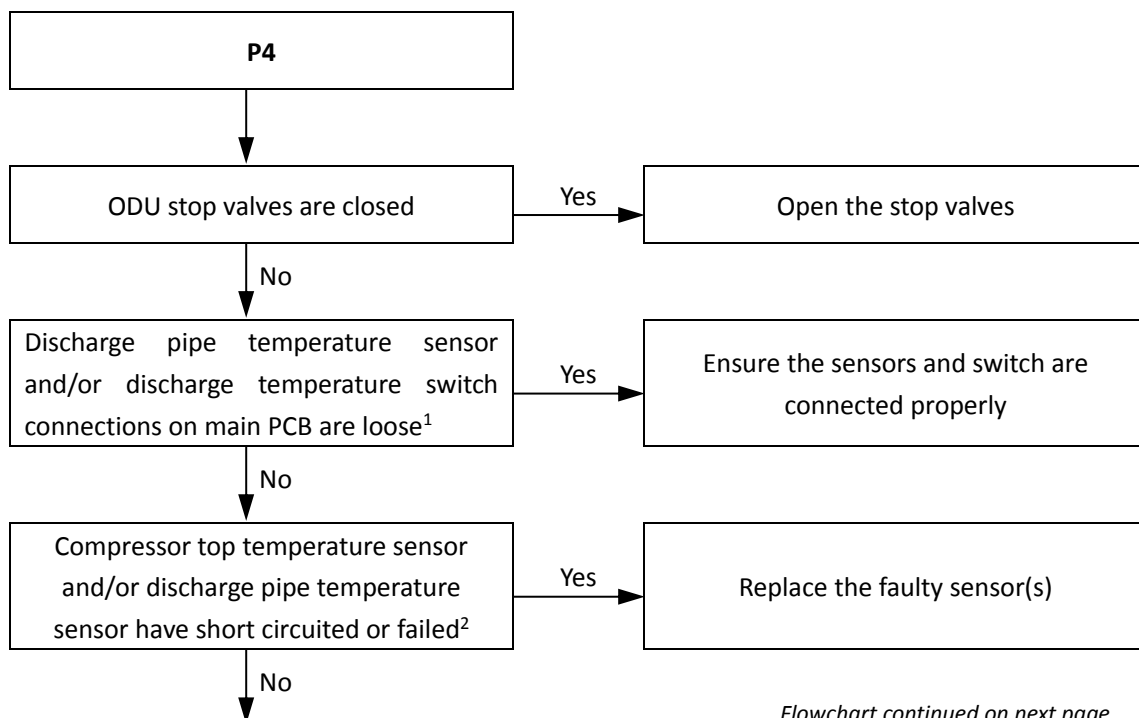

... flowchart continued from previous page

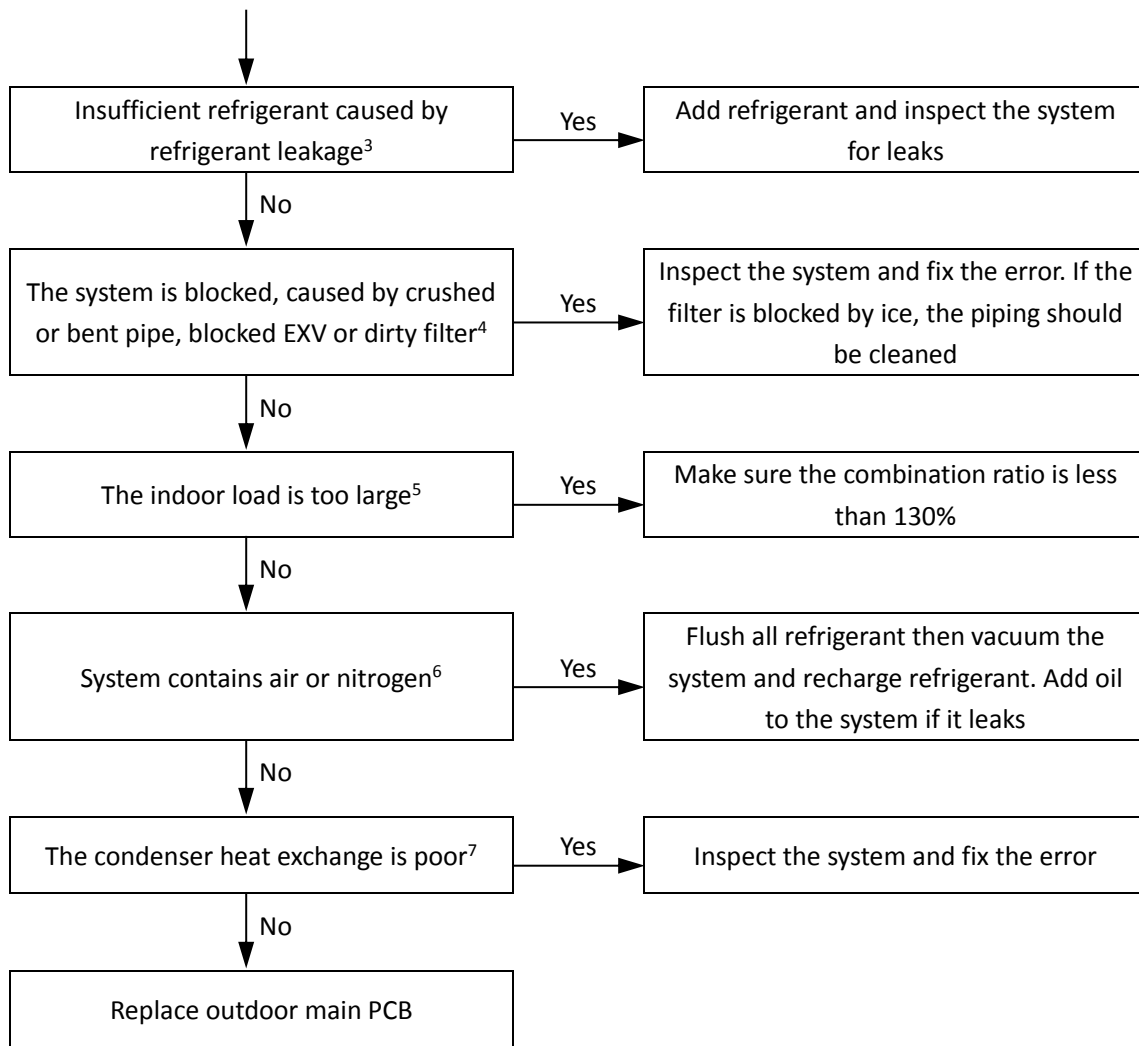

Notes:

1. Compressor top temperature sensor and discharge pipe temperature sensor connections are ports CN4 and CN5 on the main PCB (labeled 3 and 4, respectively, in Figure 5-2.1 in Part 5, 2.1 "Ports"). The discharge temperature switch connection is port CN18 on the main PCB (labeled 2 in Figure 5-2.1 in Part 5, 2.1 "Ports").
2. Measure sensor resistance. If the resistance is too low, the sensor has short-circuited. If the resistance is not consistent with the sensor's resistance characteristics table, the sensor has failed. Refer to Table 6-3.2 in Part 6, 3.1 "Temperature Sensor Resistance Characteristics".
3. An insufficiency of refrigerant causes compressor discharge temperature to be higher than normal, discharge and suction pressures to be lower than normal and compressor current to be lower than normal, and may cause frosting to occur on the suction pipe. These issues disappear once sufficient refrigerant has been charged into the system. For normal system parameters refer to Table 6-3.4 and 6-3.5 in Part 6, 3.2 "Normal Operating Parameters of Refrigerant System".
4. A low pressure side blockage causes compressor discharge temperature to be higher than normal, suction pressure to be lower than normal and compressor current to be lower than normal, and may cause frosting to occur on the suction pipe. For normal system parameters refer to Table 6-3.4 and 6-3.5 in Part 6, 3.2 "Normal Operating Parameters of Refrigerant System".
5. An indoor load that is too large causes suction and discharge temperatures to be higher than normal. For normal system parameters refer to Table 6-3.4 and 6-3.5 in Part 6, 3.2 "Normal Operating Parameters of Refrigerant System".
6. Air or nitrogen in the system causes discharge temperature to be higher than normal, discharge pressure to be higher than normal, compressor current to be higher than normal, abnormal compressor noise and an unsteady pressure meter reading. For normal system parameters refer to Table 6-3.4 and 6-3.5 in Part 6, 3.2 "Normal Operating Parameters of Refrigerant System".
7. In cooling mode check outdoor heat exchangers, fans and air outlets for dirt/blockages. In heating mode check indoor heat exchangers, fans and air outlets for dirt/blockages.

2.18 P5: Outdoor heat exchanger temperature protection

2.18.1 Digital display output



2.18.2 Description

- Outdoor heat exchanger temperature protection.
- The system stops running.
- Error code is displayed on the unit with the error.

2.18.3 Trigger / recover condition

- Trigger condition: Outdoor heat exchanger temperature (T3) $\geq 65^{\circ}\text{C}$.
- Recover condition: Outdoor heat exchanger temperature (T3) $< 55^{\circ}\text{C}$.
- Reset method: Resume automatically.

2.18.4 Possible causes

- Outdoor unit stop valves are closed.
- Temperature sensor not connected properly or has malfunctioned.
- Indoor load too large.
- System contains air or nitrogen.
- Poor condenser heat exchange.
- High pressure side blockage.
- Main PCB damaged.

2.18.5 Procedure

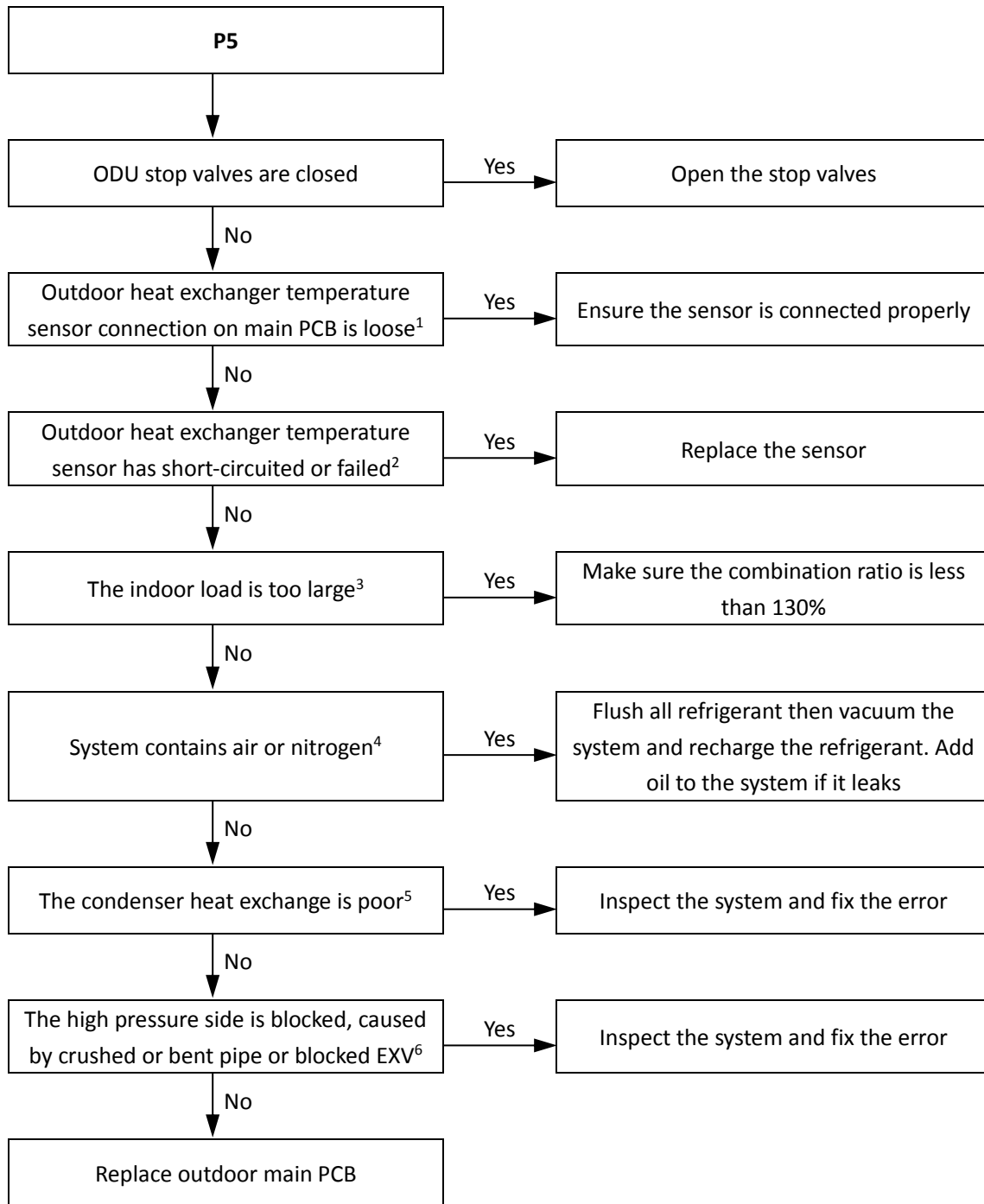

Notes:

1. Outdoor heat exchanger temperature sensor connection is port CN1 on the main PCB (labeled 11 in Figure 5-2.1 in Part 5, 2.1 "Ports").
2. Measure sensor resistance. If the resistance is too low, the sensor has short-circuited. If the resistance is not consistent with the sensor's resistance characteristics table, the sensor has failed. Refer to Table 6-3.1 in Part 6, 3.1 "Temperature Sensor Resistance Characteristics"
3. An indoor load that is too large causes suction and discharge temperatures to be higher than normal. For normal system parameters refer to Table 6-3.4 and 6-3.5 in Part 6, 3.2 "Normal Operating Parameters of Refrigerant System".
4. Air or nitrogen in the system causes discharge temperature to be higher than normal, discharge pressure to be higher than normal, compressor current to be higher than normal, abnormal compressor noise and an unsteady pressure meter reading. For normal system parameters refer to Table 6-3.4 and 6-3.5 in Part 6, 3.2 "Normal Operating Parameters of Refrigerant System".
5. In cooling mode check outdoor heat exchangers, fans and air outlets for dirt/blockages. In heating mode check indoor heat exchangers, fans and air outlets for dirt/blockages.
6. High pressure side blockage causes discharge temperature to be higher than normal, discharge pressure to be higher than normal and suction pressure to be lower than normal. For normal system parameters refer to Table 6-3.4 and 6-3.5 in Part 6, 3.2 "Normal Operating Parameters of Refrigerant System".

2.19 P8: Typhoon protection

2.19.1 Digital display output



2.19.2 Description

- P8 indicates strong wind protection.
- The system stops running.
- Error code is displayed on the outdoor unit PCB.

2.19.3 Trigger / recover condition

- Trigger condition:
Fan speed ≥ 400 rps when the outdoor unit is not start up.
- Recover condition:
Both the upper and lower fan speed < 400 rps for more than 120S.
- Reset method:
Resume automatically.

2.19.4 Possible causes

- There is strong wind around the outdoor unit.
- DC fan motor is damaged.
- Main PCB damaged.

2.19.5 Procedure

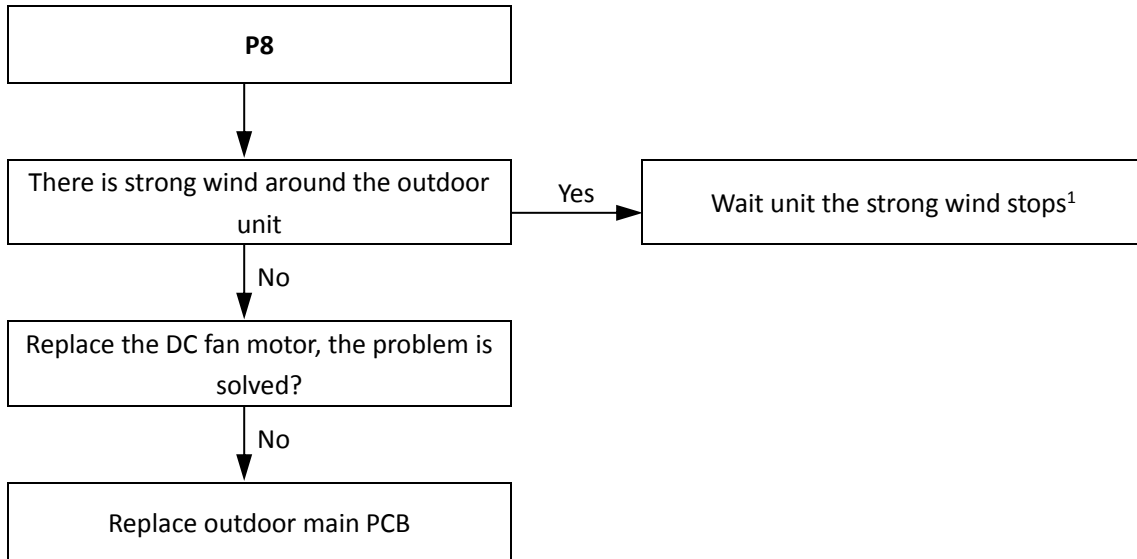

Notes:

1. P8 protection recovers in 2 minutes when the strong wind stops.

2.20 PL: Inverter module temperature protection

2.20.1 Digital display output



2.20.2 Description

- PL indicates inverter module temperature protection.
- The system stops running.
- Error code is displayed on the outdoor unit PCB.

2.20.3 Trigger / recover condition

- Trigger condition:
Inverter module heat sink temperature (Tf) $\geq 72^{\circ}\text{C}$.
- Recover condition:
Inverter module heat sink temperature (Tf) $< 66^{\circ}\text{C}$
- Reset method:
Resume automatically.

2.20.4 Possible causes

- Blocked, dirty or loose heat sink.
- Temperature sensor not connected properly or has malfunctioned.
- Main PCB damaged.

2.20.5 Procedure

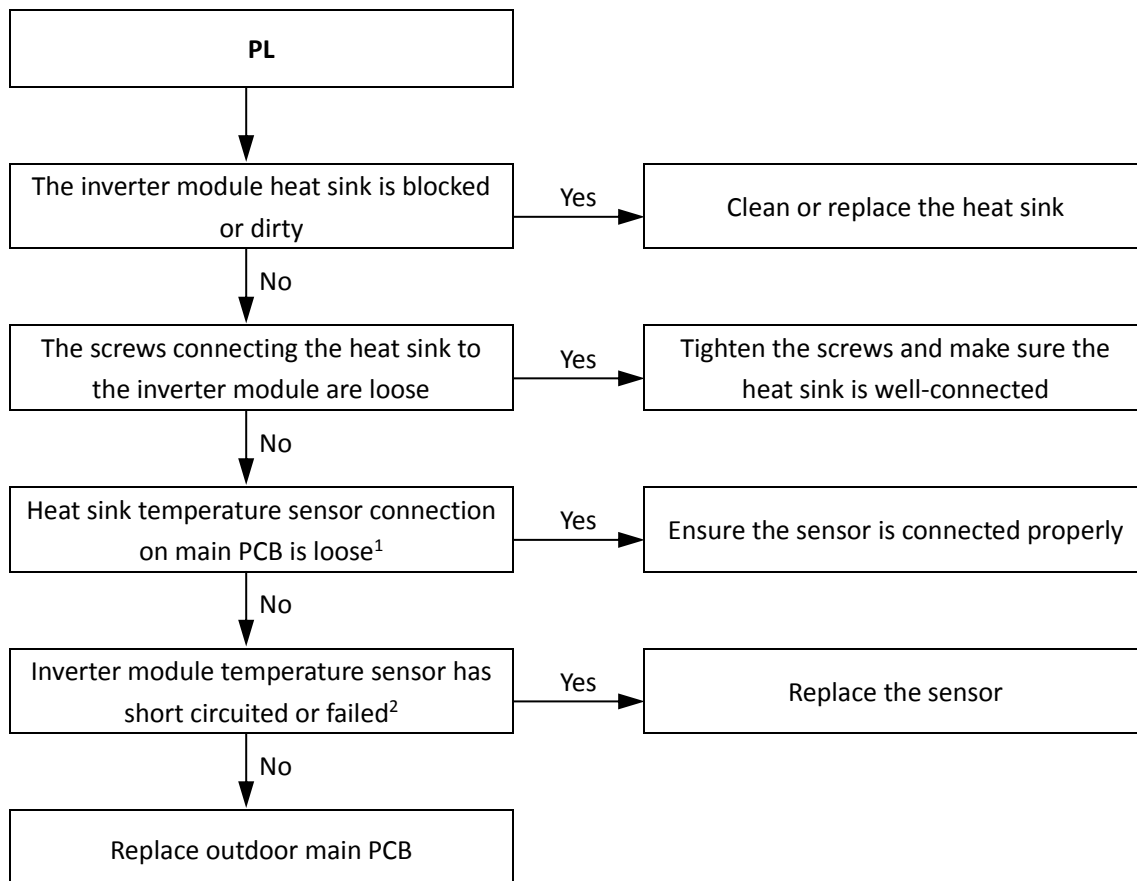

Notes:

1. Heat sink temperature sensor connection is port CN14 on the main PCB (labeled 4 in Figure 5-2.1 in Part 5, 2.1 "Ports").
2. Measure sensor resistance. If the resistance is too low, the sensor has short-circuited. If the resistance is not consistent with the sensor's resistance characteristics table, the sensor has failed. Refer to Table 6-3.3 in Part 6, 3.1 "Temperature Sensor Resistance Characteristics".

3 Appendix to Part 6

3.1 Temperature Sensor Resistance Characteristics

Table 6-3.1: Outdoor ambient temperature sensor, outdoor heat exchanger temperature sensor and refrigerant cooling pipe temperature sensor resistance characteristics

Temperature (°C)	Resistance (kΩ)	Temperature (°C)	Resistance (kΩ)	Temperature (°C)	Resistance (kΩ)	Temperature (°C)	Resistance (kΩ)
-20	115.3	20	12.64	60	2.358	100	0.6297
-19	108.1	21	12.06	61	2.272	101	0.6115
-18	101.5	22	11.50	62	2.191	102	0.5939
-17	96.34	23	10.97	63	2.112	103	0.5768
-16	89.59	24	10.47	64	2.037	104	0.5604
-15	84.22	25	10.00	65	1.965	105	0.5445
-14	79.31	26	9.551	66	1.896	106	0.5291
-13	74.54	27	9.124	67	1.830	107	0.5143
-12	70.17	28	8.720	68	1.766	108	0.4999
-11	66.09	29	8.336	69	1.705	109	0.4860
-10	62.28	30	7.971	70	1.647	110	0.4726
-9	58.71	31	7.624	71	1.591	111	0.4596
-8	56.37	32	7.295	72	1.537	112	0.4470
-7	52.24	33	6.981	73	1.485	113	0.4348
-6	49.32	34	6.684	74	1.435	114	0.4230
-5	46.57	35	6.400	75	1.387	115	0.4116
-4	44.00	36	6.131	76	1.341	116	0.4006
-3	41.59	37	5.874	77	1.291	117	0.3899
-2	39.82	38	5.630	78	1.254	118	0.3796
-1	37.20	39	5.397	79	1.2133	119	0.3695
0	35.20	40	5.175	80	1.174	120	0.3598
1	33.33	41	4.964	81	1.136	121	0.3504
2	31.56	42	4.763	82	1.100	122	0.3413
3	29.91	43	4.571	83	1.064	123	0.3325
4	28.35	44	4.387	84	1.031	124	0.3239
5	26.88	45	4.213	85	0.9982	125	0.3156
6	25.50	46	4.046	86	0.9668	126	0.3075
7	24.19	47	3.887	87	0.9366	127	0.2997
8	22.57	48	3.735	88	0.9075	128	0.2922
9	21.81	49	3.590	89	0.8795	129	0.2848
10	20.72	50	3.451	90	0.8525	130	0.2777
11	19.69	51	3.318	91	0.8264	131	0.2708
12	18.72	52	3.192	92	0.8013	132	0.2641
13	17.80	53	3.071	93	0.7771	133	0.2576
14	16.93	54	2.959	94	0.7537	134	0.2513
15	16.12	55	2.844	95	0.7312	135	0.2451
16	15.34	56	2.738	96	0.7094	136	0.2392
17	14.62	57	2.637	97	0.6884	137	0.2334
18	13.92	58	2.540	98	0.6682	138	0.2278

19	13.26	59	2.447	99	0.6486	139	0.2223
----	-------	----	-------	----	--------	-----	--------

Table 6-3.2: Compressor discharge pipe temperature sensor resistance characteristics

Temperature (°C)	Resistance (kΩ)	Temperature (°C)	Resistance (kΩ)	Temperature (°C)	Resistance (kΩ)	Temperature (°C)	Resistance (kΩ)
-30	913.239	16	83.541	62	12.809	108	2.918
-29	862.001	17	79.801	63	12.357	109	2.835
-28	813.806	18	76.248	64	11.923	110	2.755
-27	768.47	19	72.871	65	11.506	111	2.678
-26	725.821	20	69.66	66	11.105	112	2.603
-25	685.694	21	66.607	67	10.721	113	2.53
-24	647.937	22	63.703	68	10.352	114	2.46
-23	612.405	23	60.939	69	9.997	115	2.392
-22	578.963	24	58.31	70	9.656	116	2.326
-21	547.482	25	55.807	71	9.329	117	2.262
-20	517.845	26	53.424	72	9.014	118	2.2
-19	489.937	27	51.154	73	8.711	119	2.141
-18	463.653	28	48.992	74	8.42	120	2.082
-17	438.895	29	46.933	75	8.14	121	2.026
-16	415.569	30	44.97	76	7.871	122	1.972
-15	393.587	31	43.098	77	7.612	123	1.919
-14	372.869	32	41.314	78	7.363	124	1.868
-13	353.337	33	39.613	79	7.123	125	1.818
-12	334.92	34	37.989	80	6.892	126	1.77
-11	317.549	35	36.441	81	6.67	127	1.723
-10	301.161	36	34.963	82	6.456	128	1.678
-9	285.699	37	33.552	83	6.249	129	1.635
-8	271.104	38	32.205	84	6.051	130	1.592
-7	257.326	39	30.919	85	5.859	131	1.551
-6	244.316	40	29.691	86	5.675	132	1.511
-5	232.028	41	28.517	87	5.497	133	1.472
-4	220.418	42	27.395	88	5.325	134	1.435
-3	209.447	43	26.323	89	5.16	135	1.399
-2	199.077	44	25.298	90	5	136	1.363
-1	189.272	45	24.318	91	4.846	137	1.329
0	179.999	46	23.381	92	4.697	138	1.296
1	171.227	47	22.485	93	4.554	139	1.264
2	162.926	48	21.627	94	4.415	140	1.233
3	155.07	49	20.806	95	4.282	141	1.203
4	147.632	50	20.021	96	4.152	142	1.174
5	140.589	51	19.269	97	4.027	143	1.146
6	133.917	52	18.548	98	3.907	144	1.119
7	127.596	53	17.859	99	3.79	145	1.093
8	121.605	54	17.198	100	3.677	146	1.067
9	115.926	55	16.565	101	3.568	147	1.043
10	110.54	56	15.958	102	3.463	148	1.019
11	105.433	57	15.377	103	3.361	149	0.996
12	100.587	58	14.82	104	3.262	150	0.974
13	95.988	59	14.285	105	3.166		
14	91.622	60	13.773	106	3.091		
15	87.477	61	13.281	107	3.003		

Table 6-3.3: Heat sink temperature sensor resistance characteristics

Temperature (°C)	Resistance (kΩ)	Temperature (°C)	Resistance (kΩ)	Temperature (°C)	Resistance (kΩ)	Temperature (°C)	Resistance (kΩ)
-30	971.4	10	109.0	50	19.70	90	5.000
-29	912.8	11	103.9	51	18.97	91	4.855
-28	858.2	12	99.02	52	18.26	92	4.705
-27	807.3	13	94.44	53	17.59	93	4.566
-26	759.7	14	90.11	54	16.94	94	4.431
-25	715.3	15	86.00	55	16.32	95	4.301
-24	673.6	16	82.09	56	15.73	96	4.176
-23	634.7	17	78.38	57	15.16	97	4.055
-22	598.2	18	74.87	58	14.62	98	3.938
-21	564.1	19	71.53	59	14.10	99	3.825
-20	532.2	20	68.36	60	13.60	100	3.716
-19	502.2	21	65.34	61	13.12	101	3.613
-18	474.1	22	62.47	62	12.65	102	3.514
-17	447.7	23	59.75	63	12.22	103	3.418
-16	423.0	24	57.17	64	11.79	104	3.326
-15	399.8	25	54.71	65	11.39	105	3.235
-14	378.0	26	52.36	66	10.99	106	3.148
-13	357.5	27	50.13	67	10.62	107	3.063
-12	338.2	28	48.01	68	10.25	108	2.982
-11	320.1	29	45.99	69	9.909	109	2.902
-10	303.1	30	44.07	70	9.576	110	2.826
-9	287.1	31	42.23	71	9.253	111	2.747
-8	272.0	32	40.48	72	8.947	112	2.672
-7	257.8	33	38.81	73	8.646	113	2.599
-6	244.4	34	37.23	74	8.362	114	2.528
-5	231.9	35	35.71	75	8.089	115	2.460
-4	220.0	36	34.27	76	7.821	116	2.390
-3	208.7	37	32.89	77	7.569	117	2.322
-2	198.2	38	31.58	78	7.323	118	2.256
-1	188.2	39	30.33	79	7.088	119	2.193
0	178.8	40	29.13	80	6.858	120	2.132
1	169.9	41	27.98	81	6.640	121	2.073
2	161.5	42	26.89	82	6.432	122	2.017
3	153.6	43	25.85	83	6.230	123	1.962
4	146.1	44	24.85	84	6.033	124	1.910
5	139.1	45	23.90	85	5.847	125	1.859
6	132.3	46	22.98	86	5.667		
7	126.0	47	22.10	87	5.492		
8	120.0	48	21.26	88	5.322		
9	114.3	49	20.47	89	5.159		

3.2 Normal Operating Parameters of Refrigerant System

Under the following conditions, the operating parameters given in Tables 6-3.4 and 6-3.5 should be observed:

- The outdoor unit can detect all the indoor units.
- The number of indoor units displayed on DSP is steady and is equal to the actual number of indoor units installed.
- All stop valves are open and all indoor unit EXVs are connected to their unit's PCB.
- All the indoor units are currently running.
- If the outdoor ambient temperature is high, the system is being run in cooling mode with the following settings: temperature 17°C; fan speed high.
- If the outdoor ambient temperature is low, the system is being run in heating mode with the following settings: temperature 30°C; fan speed high.
- The system has been running normally for more than 30 minutes.

Table 6-3.4: Outdoor unit cooling mode operating parameters

Outdoor ambient temperature	°C	< 10	10 to 26	26 to 31	31 to 41	> 41
Average discharge temperature	°C	60-76	62-78	65-82	67-92	69-92
Average discharge superheat	°C	17-30	17-33	17-34	17-36	10-32
Discharge pressure	MPa	2.3-2.8	2.3-2.8	2.4-3.6	2.6-3.8	3.1-4.2
Suction pressure	MPa	0.6-0.7	0.7-0.9	0.8-1.0	1.0-1.2	1.2-1.4
DC inverter compressor current	A	7-18	10-20	12-25	15-27	18-25

Table 6-3.5: Outdoor unit heating mode operating parameters

Outdoor ambient temperature	°C	< -10	-10 to 0	0 to 5	5 to 10	10 to 17	> 17
Average discharge temperature	°C	56-74	57-76	58-78	61-82	63-82	63-82
Average discharge superheat	°C	17-35	17-35	17-35	17-33	14-33	14-33
Discharge pressure	MPa	1.7-2.4	1.8-2.5	1.9-3.0	2.2-3.2	2.3-3.2	2.3-3.2
Suction pressure	MPa	1.4-1.6	1.5-1.7	1.6-2.2	1.8-2.6	1.8-2.6	2.0-2.4
DC inverter compressor current	A	11-23	12-25	10-25	10-26	10-22	13-20