



DC Inverter U-match Series Floor Ceiling Type Unit

Installation Manual

Air Conditioners



Models:



Indoor Unit	Outdoor Unit
GTH09K3FI	GUHD09NK3FO
GTH12K3FI	GUHD12NK3FO
GTH18K3FI	GUHD18NK3FO
GTH24K3FI	GUHD24NK3FO
GTH30K3FI	GUHD30NK3FO
GTH36K3FI	GUHD36NK3FO
GTH42K3FI	GUHD42NK3FO
GTH48K3FI	GUHD48NK3FO
GTH36K3FI	GUHD36NM3FO
GTH42K3FI	GUHD42NM3FO
GTH48K3FI	GUHD48NM3FO
GTH60K3FI	GUHD60NM3FO

- Thank you for choosing our product.
- For proper operation, please read and keep this manual carefully.
- If you have lost the Owner's Manual, please contact the local agent or visit www.gree.com or sent email to global@gree.com.cn or electronic version.
- GREE reserves the right to interpret this manual which will be subject to any change due to product improvement without further notice.
- GREE Electric Appliances, Inc. of Zhuhai reserves the final right to interpret this manual.

Contents

1 Safety Precautions	1
2 Outline of the Unit and Main Parts.....	2
3 Preparative for Installation.....	3
3.1 Standard Accessory Parts	3
3.2 Selection of the Installation Location.....	4
3.3 Connection Pipe Requirement	5
3.4 Electrical Requirement	6
4 Installation of the Unit.....	8
4.1 Installation of the Indoor Unit.....	8
4.2 Installation of the Outdoor Unit.....	10
4.3 Installation of the Connection Pipe	12
4.4 Vacuum and Gas Leakage Inspection.....	15
4.5 Installation of the Drain Pipe	17
4.6 Electrical Wiring.....	19
5 Installation of Controllers	24
6 Test Running.....	24
6.1 Trial Operation and Testing.....	24
6.2 Working Temperature Range.....	26
7. Troubleshooting and Maintenance	27
7.1 Troubleshooting	27
7.2 Routine Maintenance	28

1 Safety Precautions

 WARNING!	This mark indicates procedures which, if improperly performed, might lead to the death or serious injury of the user.
 CAUTION!	This mark indicates procedures which, if improperly performed, might possibly result in personal harm to the user, or damage to property.

 WARNING!	
	(1). For operating the air conditioner pleasantly, install it as outlined in this installation manual.
	(2). Connect the indoor unit and outdoor unit with the room air conditioner piping and cord available from our standard parts. This installation manual describes the correct connections using the installation set available from our standard parts.
	(3). Installation work must be performed in accordance with national wiring standards by authorized personnel only.
	(4). If refrigerant leaks while work is being carried out, ventilate the area. If the refrigerant comes in contact with a flame, it produces toxic gas.
	(5). Do not power on until all installation work is complete.
	(6). During installation, make sure that the refrigerant pipe is attached firmly before you run the compressor. Do not operate the compressor under the condition of refrigerant piping not attached properly with 2-way or 3-way valve open. This may cause abnormal pressure in the refrigeration cycle that leads to breakage and even injury.
	(7). During the pump-down operation, make sure that the compressor is turned off before you remove the refrigerant piping. Do not remove the connection pipe while the compressor is in operation with 2-way or 3-way valve open. This may cause abnormal pressure in the refrigerant cycle that leads to breakage and even injury.
	(8). When installing and relocating the air conditioner, do not mix gases other than the specified refrigerant (R410A) to enter the refrigerant cycle. If air or other gas enters the refrigerant cycle, the pressure inside the cycle will rise to an abnormally high value and cause breakage, injury, etc.
	(9). This appliance is not intended for use by persons (including children) with reduced physical, sensory or mental capabilities, or lack of experience and knowledge, unless they have been given supervision or instruction concerning use of the appliance by a person responsible for their safety.
	(10). Children should be supervised to ensure that they do not play with the appliance.
	(11). If the supply cord is damaged, it must be replaced by the manufacturer, its service agent or similarly qualified persons in order to avoid a hazard.

2 Outline of the Unit and Main Parts

Indoor

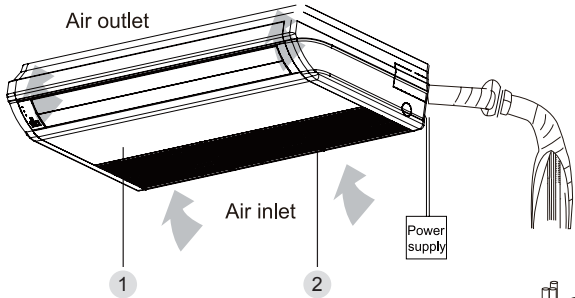

Outdoor

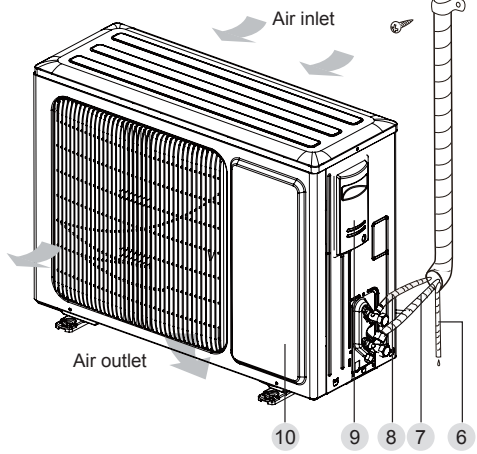

1. Guide louver
2. Air filter
3. Wired controller
4. Wireless Controller
5. Binding tape
6. Drain Pipe
7. Gas Pipe
8. Lipuid Pipe
9. Big Handle
10. Front Board

Fig.1

Notes:

- ① . The connection pipe and duct for this unit should be prepared by the user.
- ② . This unit is standard equipped with the rectangular duct.

3 Preparative for Installation

3.1 Standard Accessory Parts

The standard accessory parts listed below are furnished and should be used as required.

Table 1











Indoor Unit Accessories				
No.	Name	Appearance	Q'ty	Usage
1	Nut with Washer		8	To fix the hook on the cabinet of the unit.
2	Wireless Controller+Battery		1+2	To control the indoor unit
3	Insulation		1	To insulate the gas pipe
4	Insulation		1	To insulate the liquid pipe
5	Installation Paperboard		2	To insulate the drain pipe
6	Fastener		4	To fasten the sponge
7	Nut		1	To connect gas pipe
8	Nut		1	To connect liquid pipe

Table 2

Outdoor Unit Accessories				
No.	Name	Appearance	Q'ty	Usage
1	Drain Plug		3	To plug the unused drain hole.
2	Drainage Connector		1	To connect with the hard PVC drain pipe

3.2 Selection of the Installation Location

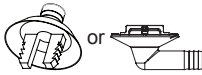
 WARNING!
The unit must be installed where strong enough to withstand the weight of the unit and fixed securely, otherwise the unit would topple or fall off.
 CAUTION!
① . Do not install where there is a danger of combustible gas leakage.
② . Do not install the unit near heat source, steam, or flammable gas.
③ . Children under 10 years old must be supervised not to operate the unit.

Decide the installation location with the customer as follows:

3.2.1 Indoor Unit

- (1). Install the unit at a place where is strong enough to withstand the weight of the unit.
- (2). The air inlet and outlet of the unit should never be clogged so that the airflow can reach every corner of the room.
- (3). Leave service space around the unit as required in Fig.2.

◆ Floor type

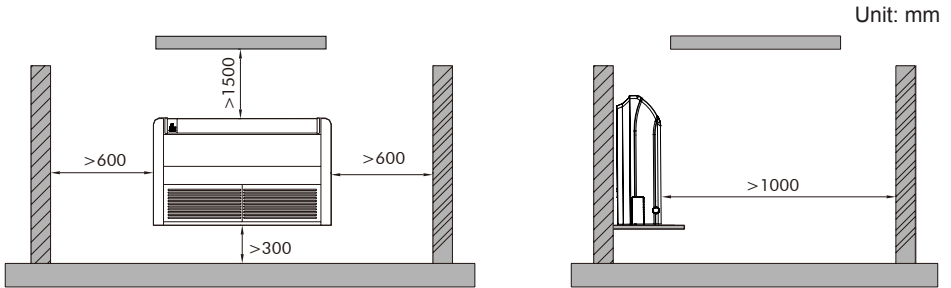

◆ Ceiling type

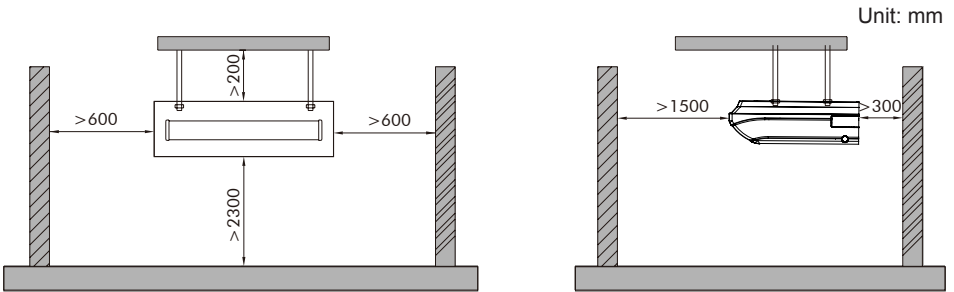

Fig. 2

- (4). Install the unit where the drain pipe can be easily installed.
- (5). The space from the unit to the ceiling should be kept as much as possible so as for more convenient service.

3.2.2 Outdoor Unit



WARNING!

- ① . Install the unit where it will not be tilted by more than 5°.
- ② . During installation, if the outdoor unit has to be exposed to strong wind, it must be fixed securely.

If possible, do not install the unit where it will be exposed to direct sunlight. (If necessary, install a blind that does not interfere with the air flow.)

- (1). Install the outdoor unit in a place where it will be free from being dirty or getting wet by rain as much as possible.
- (2). Install the outdoor unit where it is convenient to connect with the indoor unit.
- (3). Install the outdoor unit where the condensate water can be drained out freely during heating operation.
- (4). Do not place animals and plants in the path of the warm air.
- (5). Take the air conditioner weight into account and select a place where noise and vibration are small.
- (6). Install the outdoor unit where is capable of withstanding the weight of the unit and generates as less noise and vibration as possible.
- (7). Provide the space shown in Fig.3, so that the air flow is not blocked. Also for efficient operation, leave three of four directions of peripheral constructions open.

Units: mm

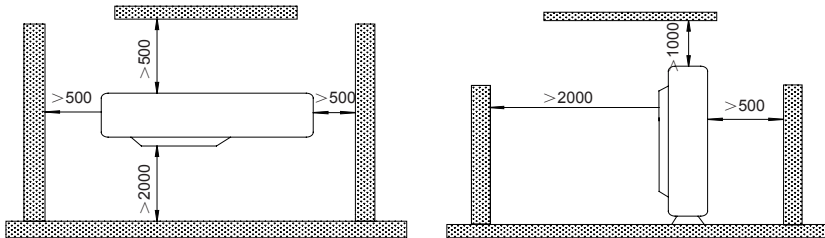

Fig.3

3.3 Connection Pipe Requirement



CAUTION!

The maximum length of the connection pipe is listed in the table below. Do not place the units between which the distance exceeds the maximum length of the connection pipe.

Table 3

Item Model		Size of Fitting Pipe(Inch)		Max. Pipe Length (m)	Max. Height Difference between Indoor Unit and Outdoor Unit (m)	Drainage pipe(Outer Diameter × wall thickness) (mm)
		Liquid	Gas			
GTH09K3FI	GUHD09NK3FO	1/4	3/8	20	15	φ17×1.75
GTH12K3FI	GUHD12NK3FO	1/4	3/8	20	15	φ17×1.75
GTH18K3FI	GUHD18NK3FO	1/4	1/2	20	15	φ17×1.75
GTH24K3FI	GUHD24NK3FO	3/8	5/8	30	15	φ17×1.75
GTH30K3FI	GUHD30NK3FO	3/8	5/8	30	15	φ17×1.75
GTH36K3FI	GUHD36NK3FO	3/8	5/8	30	15	φ17×1.75
GTH42K3FI	GUHD42NK3FO	3/8	5/8	50	30	φ17×1.75
GTH48K3FI	GUHD48NK3FO	3/8	5/8	50	30	φ17×1.75
GTH36K3FI	GUHD36NM3FO	3/8	5/8	30	15	φ17×1.75
GTH42K3FI	GUHD42NM3FO	3/8	5/8	50	30	φ17×1.75
GTH48K3FI	GUHD48NM3FO	3/8	5/8	50	30	φ17×1.75
GTH60K3FI	GUHD60NM3FO	3/8	3/4	50	30	φ17×1.75

- (1). The connecting pipe should be thermally insulated properly.
- (2). The pipe wall thickness shall be 0.5-1.0mm and the pipe wall shall be able to withstand the pressure of 6.0 MPa. The longer the connecting pipe, the lower the cooling and heating effect performs.
- (3). The pipe wall thickness shall be 0.5-1.0mm and the pipe wall shall be able to withstand the pressure of 6.0 MPa. The longer the connecting pipe, the lower the cooling and heating effect performs.

3.4 Electrical Requirement

Electric Wire Size and Fuse Capacity.

Table 4

Indoor Units	Power Supply	Fuse Capacity	Breaker Capacity	Min. Power Supply Cord
	V/Ph/Hz	A	A	mm ²
09K~60K	220-240V~ 50Hz	5	6	1.0

Table 5

Model	Power Supply	Capability of Air Switch(A)	Minimum Sectional Area of Power Cable and Earth line (mm ²)
GUHD09NK3FO	220-240V ~ 50Hz	13	1.5
GUHD12NK3FO		13	1.5
GUHD18NK3FO		16	1.5
GUHD24NK3FO		20	2.5
GUHD30NK3FO		20	2.5
GUHD36NK3FO		25	2.5
GUHD42NK3FO		25	2.5
GUHD48NK3FO		40	6.0
GUHD36NM3FO	380-415V 3N ~ 50Hz	10	1.5
GUHD42NM3FO		10	1.5
GUHD48NM3FO		16	1.5
GUHD60NM3FO		16	1.5

Notes:

- ① . The fuse is located on the main board.
- ② . Install the disconnect device with a contact gap of at least 3mm in all poles nearby the units (Both indoor unit and outdoor unit).The appliance must be positioned so that the plug is accessible.
- ③ . The specifications of the breaker and power cable listed in the table above are determined based on the maximum power (maximum amps) of the unit.
- ④ . The specifications of the power cable listed in the table above are applied to the conduit-guarded multi-wire copper cable (like, YJV copper cable, consisting of PE insulated wires and a PVC cable jacket) used at 40°C and resistible to 90°C(see IEC 60364-5-52). If the working condition changes, they should be modified according to the related national standard.
- ⑤ . The specifications of the breaker listed in the table above are applied to the breaker with the working temperature at 40°C. If the working condition changes, they should be modified according to the related national standard.
- ⑥ . Take 2 pieces of power cord of 0.75mm² as the communication lines between indoor and outdoor unit, with their longest lengths of 50m. Please select the appropriate line length as per the actual installation conditions. The communication lines can not be twisted together. For the unit (≤30K), it's recommended to use 8m long communication line.
- ⑦ . Take 2 pieces of power cord of 0.75mm² as the communication lines between the wired controller and the indoor unit, with their longest lengths of 30m. Please select the appropriate line length as per the actual installation conditions. The communication lines can not be twisted together. It's recommended to use 8m long communication line.
- ⑧ . The wire size of the communication line should be no less than 0.75mm². It's recommended to take 0.75mm² power cords as the communication line.

4 Installation of the Unit

4.1 Installation of the Indoor Unit

4.1.1 Indoor unit dimension

 WARNING !
① . Install the indoor unit in a location which can withstand a load of at least five times the weight of the main unit and which will not amplify sound or vibration.
② . If the installation location is not strong enough, the indoor unit may fall and cause injuries.
③ . If the job is done with the panel frame only, there is a risk that the unit will come loose. Please take care.

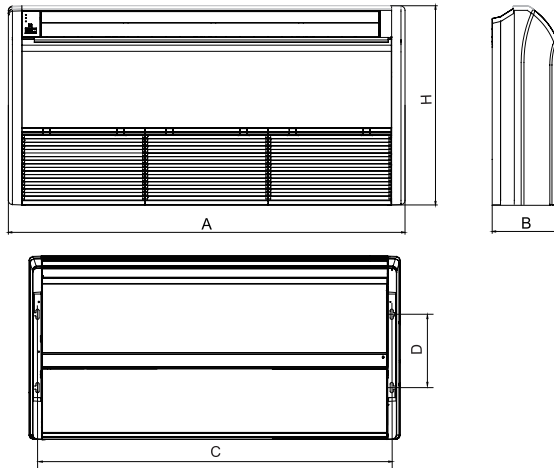

Fig.4

Table 6

Model	A	B	C	D	H
GTH09K3FI	1220	225	1158	280	700
GTH12K3FI					
GTH18K3FI					
GTH24K3FI					
GTH30K3FI	1420	245	1354	280	700
GTH36K3FI					
GTH42K3FI					
GTH48K3FI	1700	245	1634	280	700
GTH60K3FI					

4.1.2 Preparation for Installing the Indoor Unit

- (1). Open the air inlet grille and the screw cover, and remove the screws.
- (2). Release the claws in the 3 places indicated.
- (3). Release the center hook and remove the front panel.
- (4). Release the claws in the 2 or 3 places indicated and remove the electric component cover.

4.1.3 Indoor Unit Installation

- (1). Determine the location of the hanger through the paper template, and then remove the paper template.

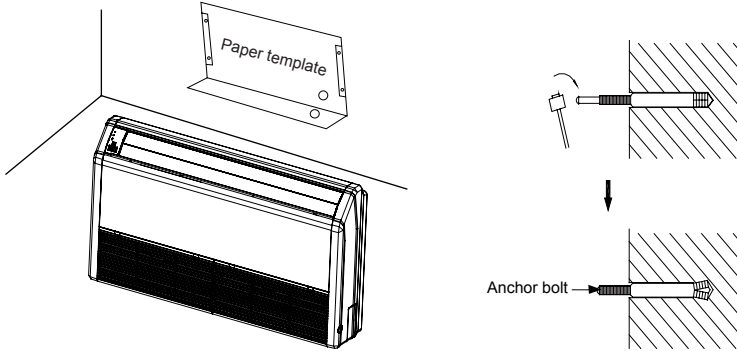

Fig.5

- (2). Insert the anchor bolts into the drilled holes, and drive the pins completely into the anchor bolts with a hammer.
- (3). Remove the right and left side panels.
- (4). Put the hanger bolt into the clasp of the indoor unit and tighten screws on the hanger to prevent the indoor unit from moving.
- (5). Reinstall and tighten the right and left side panels.

◆ Floor type

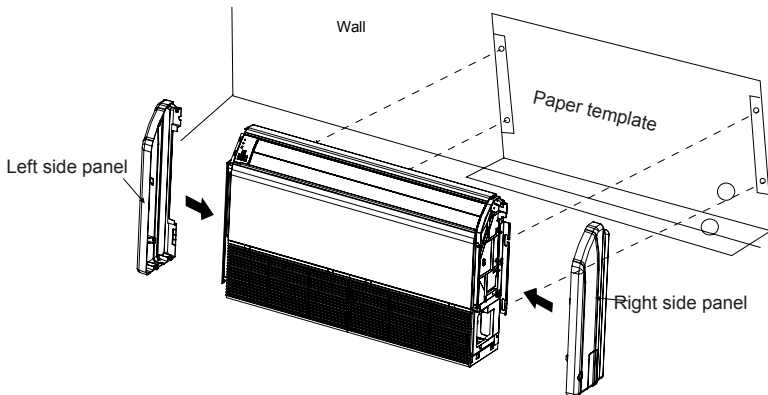

Fig.6

◆ Ceiling type

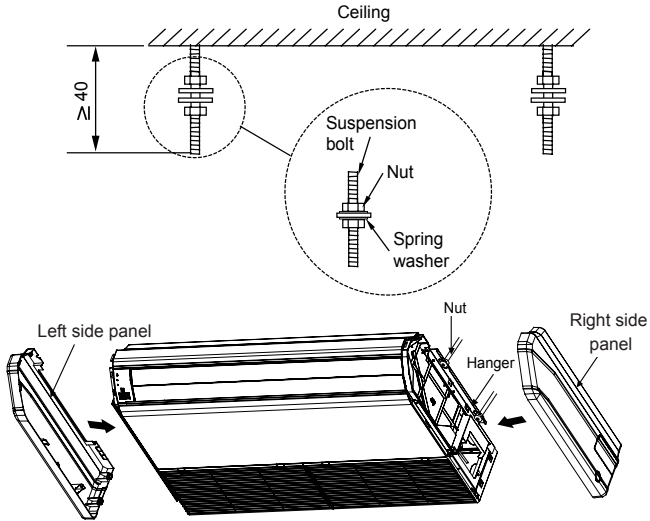

Fig.7

(6). Adjust the height of the unit to make the drain pipe slant slightly downward so that the drainage will become much smoother.

4.1.4 Leveling

The water level test must be done after installing the indoor unit to make the unit is horizontal, as shown below.

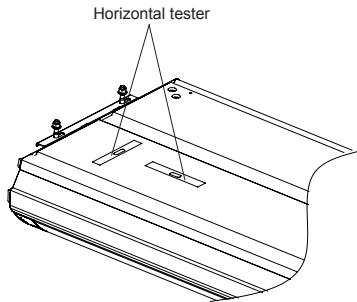

Fig.8

4.2 Installation of the Outdoor Unit



WARNING

- ① . Install the unit where it will not be tilted by more than 5°.
- ② . During installation, if the outdoor unit has to be exposed to strong wind, it must be fixed securely.

4.2.1 Outdoor unit dimension

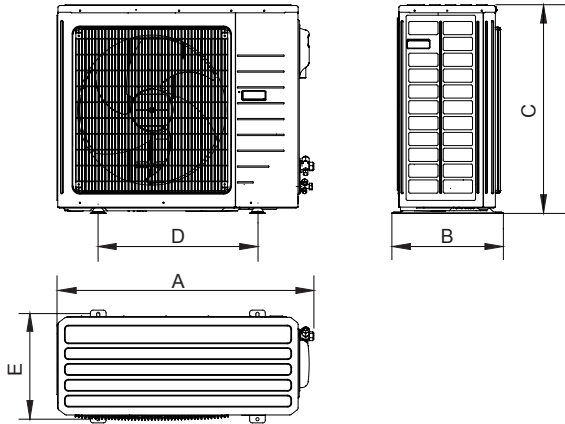

Fig.9

Table 7

Unit: mm

Item	A	B	C	D	E
Model					
GUHD09NK3FO	848	320	540	540	286
GUHD12NK3FO					
GUHD18NK3FO	955	396	700	560	360
GUHD24NK3FO	980	427	790	610	395
GUHD30NK3FO					
GUHD36NK3FO	1107	440	1100	631	400
GUHD36NM3FO					
GUHD42NM3FO	958	412	1349	572	376
GUHD42NK3FO					
GUHD48NK3FO					
GUHD48NM3FO					
GUHD60NM3FO	1085	427	1365	620	395

4.2.2 Condensate Drainage of the Outdoor Unit(Only for the heat pump unit) (Fig.10)

- (1). It is required to install a drain pipe for the outdoor unit to drain out the condensate water during heating operation. (only for the heat pump unit)
- (2). When installing the drain pipe, apart from the drain pipe mounting hole, all other holes should be plugged so as to avoid water leakage.(only for the heat pump unit)
- (3). Installation Method: Insert the pipe joint into the hole $\varnothing 25$ located at the base plate of the unit and then connect the drain pipe to the pipe joint.

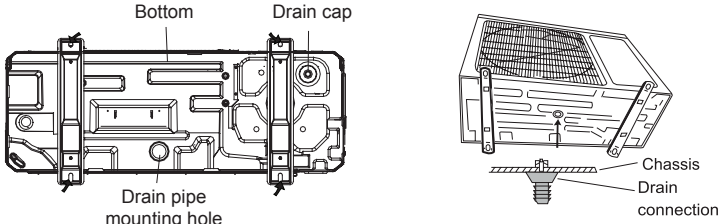

Fig.10

4.3 Installation of the Connection Pipe

4.3.1 Flare Processing

- (1). Cut the connection pipe with the pipe cutter and remove the burrs.
- (2). Hold the pipe downward to prevent cuttings from entering the pipe.
- (3). Remove the flare nuts at the stop valve of the outdoor unit and inside the accessory bag of the indoor unit, then insert them to the connection pipe, after that, flare the connection pipe with a flaring tool.
- (4). Check if the flare part is spread evenly and there are no cracks (see Fig.11).

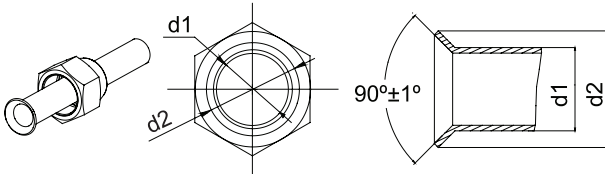

Fig.11

4.3.2 Bending Pipes

- (1). The pipes are shaped by your hands. Be careful not to collapse them.

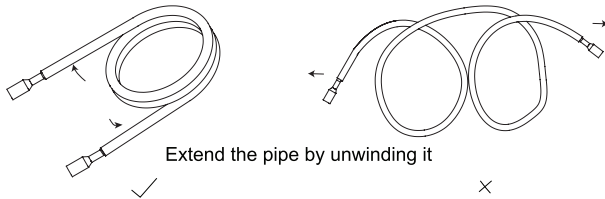

Fig.12

- (2). Do not bend the pipes in an angle more than 90°.
- (3). When pipes are repeatedly bent or stretched, the material will harden, making it difficult to bend or stretch them any more. Do not bend or stretch the pipes more than three times.

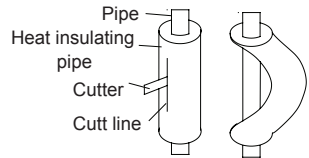

Fig.13

- (4). When bending the pipe, do not bend it as is. The pipe will be collapsed. In this case, cut the heat insulating pipe with a sharp cutter as shown in Fig.13, and bend it after exposing the pipe. After bending the pipe as you want, be sure to put the heat insulating pipe back on the pipe, and secure it with tape.

⚠ CAUTION!

- ① . To prevent breaking of the pipe, avoid sharp bends. Bend the pipe with a radius of curvature of 150 mm or over.
- ② . If the pipe is bent repeatedly at the same place, it will break.

4.3.3 Connecting the Pipe at the Indoor Unit Side

Detach the caps and plugs from the pipes.

⚠ CAUTION!

- ① . Be sure to apply the pipe against the port on the indoor unit correctly. If the centering is improper, the flare nut cannot be tightened smoothly. If the flare nut is forced to turn, the threads will be damaged.
- ② . Do not remove the flare nut until the connection pipe is to be connected so as to prevent dust and impurities from coming into the pipe system.

When connecting the pipe to the unit or removing it from the unit, please do use both the spanner and the torque wrench.(Fig.14)

When connecting, smear both inside and outside of the flare nut with refrigeration oil, screw it hand tight and then tighten it with the spanner.

Refer to Table 10 to check if the wrench has been tightened properly (too tight would mangle the nut and lead to leakage).

Examine the connection pipe to see if it leaks, then take the treatment of heat insulation, as shown in the Fig.15.

Use the medium-sized sponge to insulate the coupler of the gas pipe.

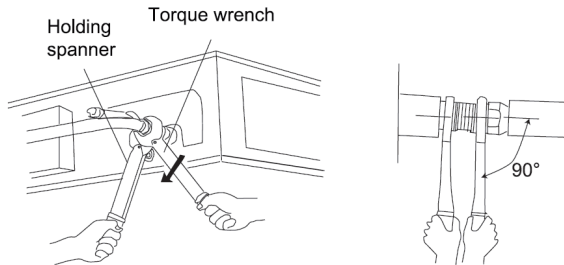

Fig.14

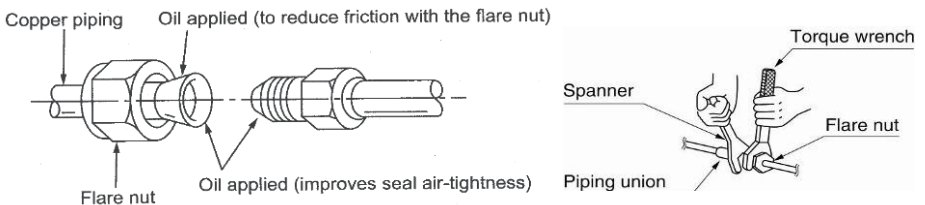

Fig.15

Table 8 Flare nut tightening torque

Pipe Diameter	Tightening Torque
1/4"(Inch)	15-30 (N·m)
3/8"(Inch)	35-40 (N·m)
5/8"(Inch)	60-65 (N·m)
1/2"(Inch)	45-50 (N·m)
3/4"(Inch)	70-75 (N·m)
7/8"(Inch)	80-85 (N·m)



Be sure to connect the gas pipe after connecting the liquid pipe completely.

4.3.4 Connecting the Pipe at the Outdoor Side Unit

Tighten the flare nut of the connection pipe at the outdoor unit valve connector. The tightening method is the same as that as at the indoor side.

4.3.5 Checking the Pipe Connections for Gas Leaking

For both indoor and outdoor unit side, check the joints for gas leaking by the use of a gas leakage detector without fail when the pipes are connected.

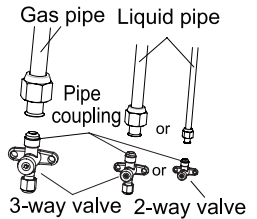

Fig.16

4.3.6 Heat Insulation on the Pipe Joints (Indoor Side Only)

Stick coupler heat insulation (large and small) to the place where connecting pipes.

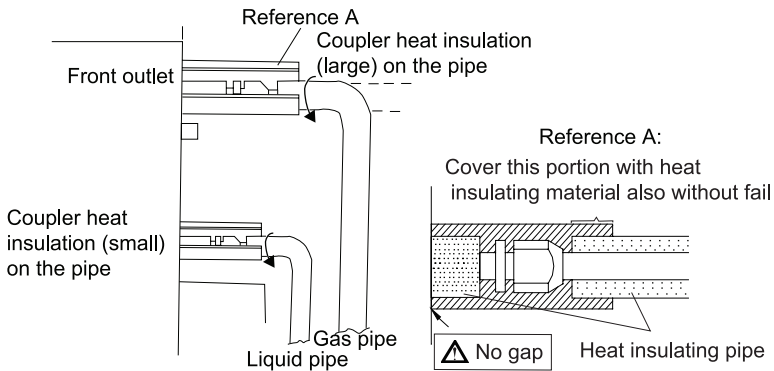

Fig.17

4.3.7 Liquid Pipe and Drain Pipe

If the outdoor unit is installed lower than the indoor unit (See Fig.18)

- (1). A drain pipe should be above ground and the end of the pipe does not dip into water. All pipes must be restrained to the wall by saddles.
- (2). Taping pipes must be done from bottom to top.
- (3). All pipes are bound together by tape and restrained to wall by saddles.

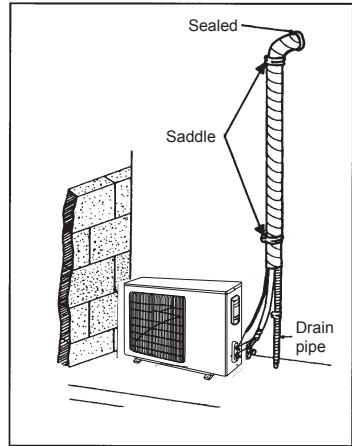

Fig.18

If the outdoor unit is installed higher than the indoor unit

- (1). Taping should be done from lower to the upper part.
- (2). All pipes are bound and taped together and also should be trapped to prevent water from returning to the room (See Fig.19)
- (3). Restraint all pipes to the wall with saddles.

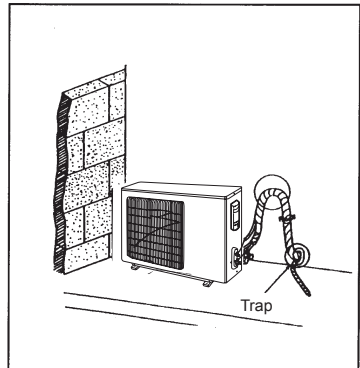

Fig.19

4.4 Vacuum and Gas Leakage Inspection



Do not purge the air with refrigerants but use a vacuum pump to vacuum the installation! There is no extra refrigerant in the outdoor unit for air purging!

4.4.1 Vacuum

- (1). Remove the caps of the liquid valve, gas valve and also the service port.
- (2). Connect the hose at the low pressure side of the manifold valve assembly to the service port of the unit's gas valve, and meanwhile the gas and liquid valves should be kept closed in case of refrigerant leak.
- (3). Connect the hose used for evacuation to the vacuum pump.
- (4). Open the switch at the lower pressure side of the manifold valve assembly and start the

vacuum pump. Meanwhile, the switch at the high pressure side of the manifold valve assembly should be kept closed, otherwise evacuation would fail.

- (5). The evacuation duration depends on the unit's capacity, generally, 15 minutes for the 09K/12K units, 20 minutes for the 18K units, 30 minutes for the 24/30/36K units, 45 minutes for the 42/48/60 units. And verify if the pressure gauge at the low pressure side of the manifold valve assembly reads -1.0Mp (-75cmHg), if not, it indicates there is leak somewhere. Then, close the switch fully and then stop the vacuum pump.
- (6). Wait for some time to see if the system pressure can remain unchanged, 3 minutes for the units less than 18K, 5 minutes for the 18K~24K units, 10 minutes for the units more than 42K. During this time, the reading of the pressure gauge at the low pressure side can not be larger than 0.005Mp (0.38cmHg).
- (7). Slightly open the liquid valve and let some refrigerant go to the connection pipe to balance the pressure inside and outside of the connection pipe, so that air will not come into the connection pipe when removing the hose. Note that the gas and liquid valve can be opened fully only after the manifold valve assembly is removed.
- (8). Place back the caps of the liquid valve, gas valve and also the service port.

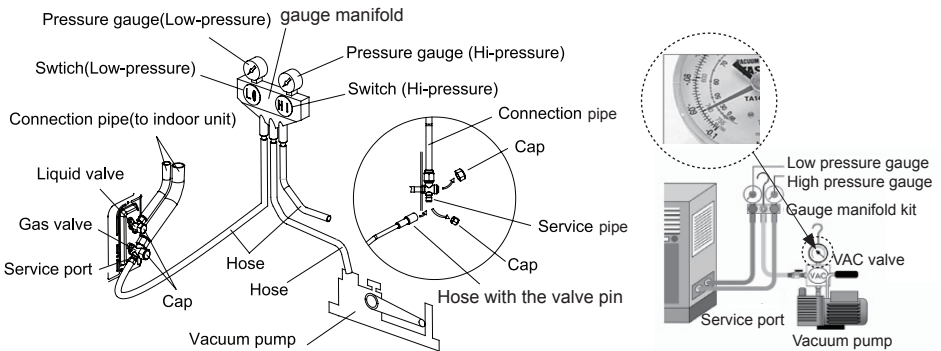

Fig.20

Note: For the large-sized unit, it has the service port for both the gas valve and the liquid valve. During evacuation, it is available to connect two hoses of the manifold valve assembly to two service ports to quicken the evacuating speed.

4.4.2 Additional Charge

ice ports to quicken the evacuating speed.

4.4.2 Additional Charge

Refrigerant suitable for a piping length of 5m is charged in the 09~42K outdoor unit at the factory, and for 48~60K outdoor unit refrigerant is charged for a piping length of 7.5m.

When the piping of 09~42k unit is longer than 7.5m or the piping of 48~60k unit is longer than 9.5m, additional charging is necessary.

For the additional amount, see Table 9.

Table 9

Model Item	Standard Pipe Length	Unnecessary Charge Pipe Length	Additional Refrigerant Amount for Extra Pipe
09~18K	5m	≤ 7.5m	30 g/m
24~42K	5m	≤ 7.5m	60 g/m
48~60K	7.5m	≤ 9.5m	60 g/m

When the height difference between the indoor unit and outdoor unit is larger than 10 meters, an oil bend should be employed for every 6 meters.

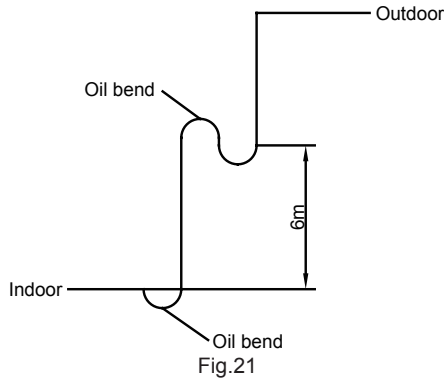

4.5 Installation of the Drain Pipe

4.5.1 Precautions When Doing the Piping Work

- (1). Keep piping as short as possible and slope it downwards at a gradient of at least 1/100 so that air may not remain trapped inside the pipe.
- (2). Keep pipe size equal to or greater than that of the connecting pipe.
- (3). Install the drain piping as shown and take measures against condensation. Improperly rigged piping could lead to leaks and eventually wet furniture and belongings.

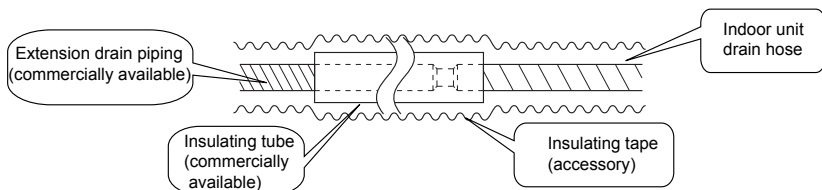

Fig.22

(4) Connect the drain hose.(Fig.23)

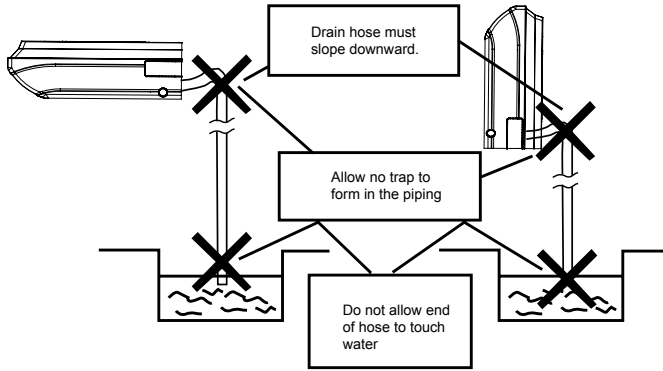

Fig.23

4.5.2 Installing the Drain Pipes

- (1). For determining the position of the drain hose, perform the following procedures.
- (2). Insert the drain pipe to the drain outlet of the unit and then tighten the clamp securely with tape. (Fig.24)
- (3). Connect the extension drain pipe to the drain pipe and then tighten the clamp with tape.

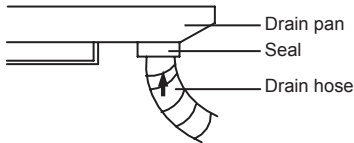

Fig.24

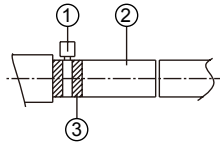

Fig.25

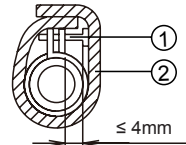

Fig.26

Tighten the clamp until the screw head is less than 4 mm from the hose.(Fig.25)

① - Metal clamp ② - Drain hose ③ - Grey tape

Insulate the pipe clamp and the drain hose using heat insulation sponge.(Fig.26)

① - Metal clamp ② - Insulation sponge

- (4). When drain hose requires extension, obtain an extension hose commercially available.
- (5). After connecting the local drain hose, tape the slits of the heat insulation tube.
- (6). Connect the drain hose to the local drain pipe. Position the inter connecting wire in the same direction as the piping.

4.5.3 Connecting the Drain Hose

- (1). Connect the extension auxiliary pipe to the local piping.
- (2). Prepare the local piping at the connection point for the drain pipe, as shown in the installation drawings.

Note: Be sure to place the drain hose as shown in the diagram below, in a downward sloping direction.

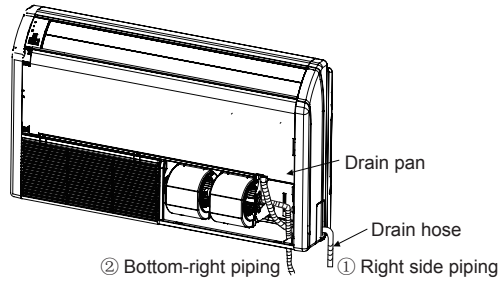

Fig.27

4.5.4 Testing of Drain Piping

- (1) After piping work is finished, check if drainage flows smoothly.
- (2) As shown in the figure, pour water into the drain pan from the right side to check that water flows smoothly from the drain hose.

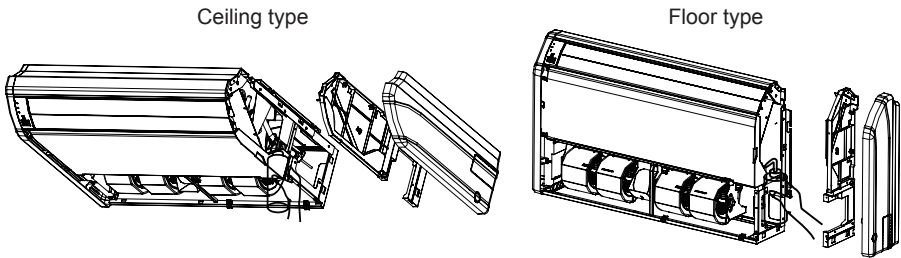

Fig.28

4.6 Electrical Wiring

4.6.1 Wiring Precautions



① . Before obtaining access to terminals, all supply circuits must be disconnected.
② . The rated voltage of the unit is as shown as Table 4 and Table 5
③ . Before turning on, verify that the voltage is within the 198~264V range(for single phrase unit) or 342~457V range (for three-phrase unit).
④ . Always use a special branch circuit and install a special receptacle to supply power to the air conditioner.
⑤ . Use a special branch circuit breaker and receptacle matched to the capacity of the air conditioner.
⑥ . The special branch circuit breaker is installed in the permanent wiring. Always use a circuit that can trip all the poles of the wiring and has an isolation distance of at least 3mm between the contacts of each pole.
⑦ . Perform wiring work in accordance with standards so that the air conditioner can be operated safely and positively.

- ⑧ . Install a leakage special branch circuit breaker in accordance with the related laws and regulations and electric company standards.

⚠ CAUTION !

- ① . The power source capacity must be the sum of the air conditioner current and the current of other electrical appliances. When the current contracted capacity is insufficient, change the contracted capacity.
- ② . When the voltage is low and the air conditioner is difficult to start, contact the power company to raise the voltage.

4.6.2 Electrical Wiring

(1). For solid core wiring (Fig.29)

- 1). Cut the wire end with a wire cutter or wire-cutting pliers, then strip the insulation about 25 mm (15/16") .
- 2). Using a screwdriver, remove the terminal screw(s) on the terminal board.
- 3). Using pliers, bend the solid wire to form a loop suitable for the terminal screw.
- 4). Shape the loop wire properly, place it on the terminal board and tighten securely with the terminal screw using a screwdriver.

(2). For strand wiring (Fig.29)

- 1). Cut the wire end with a wire cutter or wire-cutting pliers, then strip the insulation about 10 mm (3/8") .
- 2). Using a screwdriver, remove the terminal screw (s) on the terminal board.
- 3). Using a round terminal fastener or pliers, securely clamp a round terminal to each stripped wire end.
- 4). Position the round terminal wire, and replace and tighten the terminal screw with a screwdriver.(Fig.30)

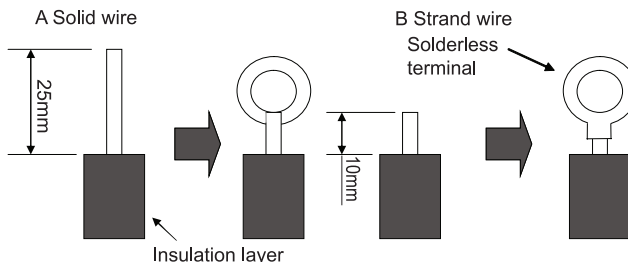

Fig.29

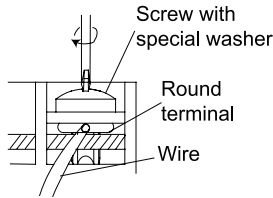
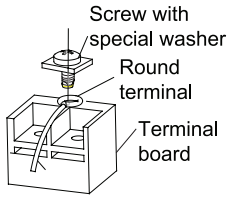

Fig.30

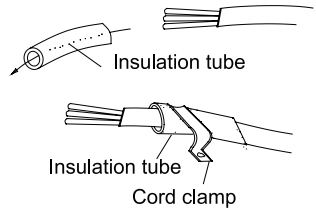

Fig.31

(3). How to fix connection cord and power cord by cord clamp

After passing the connection cord and power cord through the insulation tube, fasten it with the cord clamp.(Fig.31)

⚠ WARNING!

- ① . Before starting work, check that power is not being supplied to the indoor unit and outdoor unit.
- ② . Match the terminal block numbers and connection cord colors with those of the indoor unit side.
- ③ . Erroneous wiring may cause burning of the electric parts.
- ④ . Connect the connection cords firmly to the terminal block. Imperfect installation may cause a fire.
- ⑤ . Always fasten the outside covering of the connection cord with cord clamps. (If the insulator is not clamped, electric leakage may occur.)
- ⑥ . Always connect the ground wire.

(4). Electric wiring between the indoor and outdoor units

Single-phase units(09K~30K)

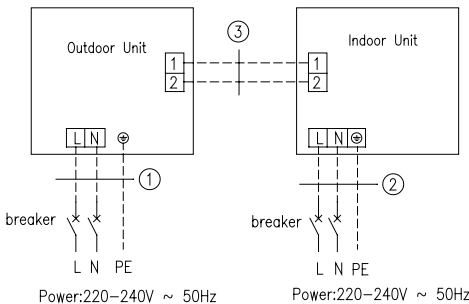

GUHD09NK3FO+GTH09K3FI
GUHD12NK3FO+GTH12K3FI
GUHD18NK3FO+GTH18K3FI
① . Power cord 3×1.5mm ² (H07RN-F)
② . Power cord 3×1.0mm ² (H05RN-F)
③ . Communication Cords 2×0.75mm ² (H05RN-F)

GUHD24NK3FO+GTH24K3FI
GUHD30NK3FO+GTH30K3FI
① . Power cord 3×2.5mm ² (H07RN-F)
② . Power cord 3×1.0mm ² (H05RN-F)
③ . Communication Cords 2×0.75mm ² (H05RN-F)

DC Inverter U-match Series Floor Ceiling Type Unit

Single-phase units(36K~48K)

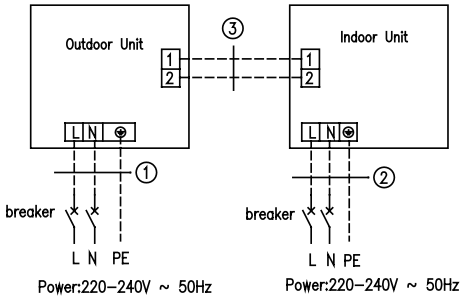

GUHD36NK3FO+GTH36K3FI
GUHD42NK3FO+GTH42K3FI
① . Power cord 3×2.5mm ² (H07RN-F)
② . Power cord 3×1.0mm ² (H05RN-F)
③ . Communication Cords 2×0.75mm ² (H05RN-F)

GUHD48NK3FO+GTH48K3FI
① . Power cord 3×6.0mm ² (H07RN-F)
② . Power cord 3×1.0mm ² (H05RN-F)
③ . Communication Cords 2×0.75mm ² (H05RN-F)

Three-phase units

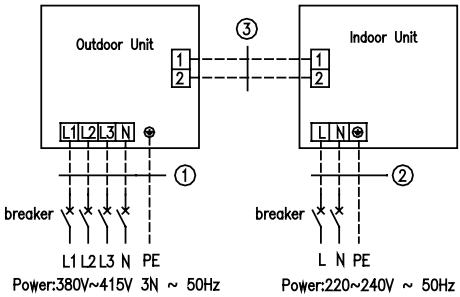

GUHD36NM3FO+GTH36K3FI
GUHD42NM3FO+GTH42K3FI
GUHD48NM3FO+GTH48K3FI
GUHD60NM3FO+GTH60K3FI
① . Power cord 5×1.5mm ² (H07RN-F)
② . Power cord 3×1.0mm ² (H05RN-F)
③ . Communication Cords 2×0.75mm ² (H05RN-F)

Fig.32

(5). Electric wiring of indoor unit side

Remove the left cover plate and the electric box cover then insert the end of the communication cord and the power cable into the terminal board.

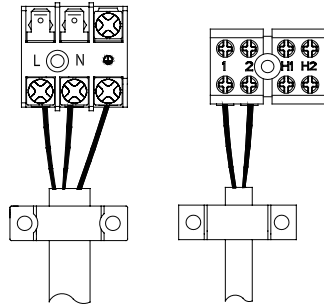
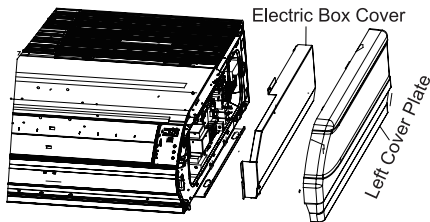

Fig.33

⚠ CAUTION!

- ① . The power cord and the wire of the fresh air valve are high-voltage, while the communication cord and connection wire of the wired controller are low-voltage. They should run separately against electromagnetic interference.
- ② . The high-voltage and low-voltage lines should pass through the rubber rings at different electric box covers.
- ③ . Do not bundle the connection wire of the wired controller and the communication cord together, or arrange them in parallel, otherwise improper operation would occur.
- ④ . The high-voltage and low-voltage lines should be fixed separately and securely, with internal big clamps for the former and small clamps for the latter.
- ⑤ . Tighten the indoor/outdoor connection cord and power cord respectively on the terminal boards with screws. Faulty connection may cause a fire.
- ⑥ . If the indoor unit connection cord (to the outdoor unit) and power supply are wired incorrectly, the air conditioner may be damaged.
- ⑦ . Connect the indoor unit connection cord properly based on the corresponding marks as shown in Fig. 32.
- ⑧ . Ground both the indoor and outdoor units by attaching a ground wire.
- ⑨ . Unit shall be grounded in compliance with the applicable local and national codes.

(6). Electric wiring of outdoor unit side

Note: When connecting the power supply cord, make sure that the phase of the power supply matches with the exact terminal board. If not, the compressor will rotate reversely and run improperly.

Remove the big handle(09~42K) /front board(48/60K) of the outdoor unit and insert the end of the communication cord and the power cable into the terminal board.

Single phase:

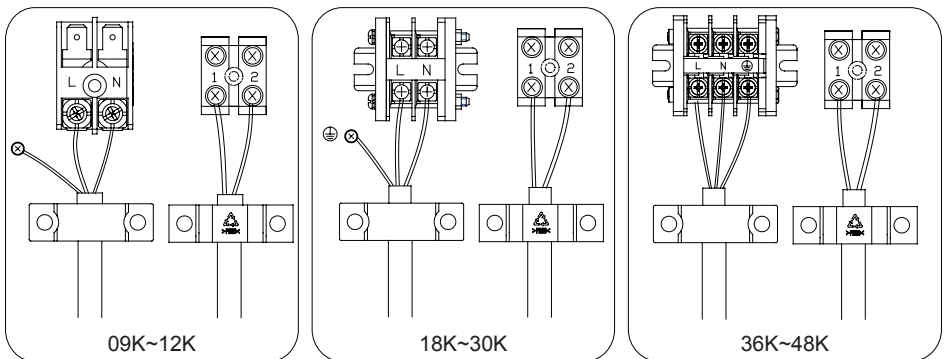

Fig.34

Three-phase:

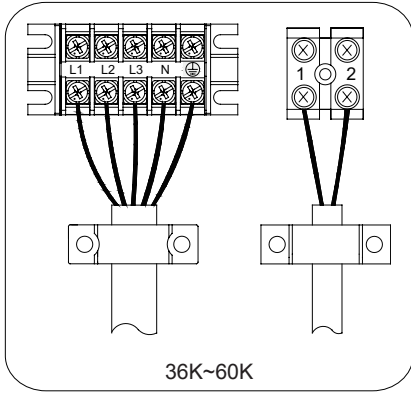

Fig.35

Power lines should go along the right side plate and be fixed to the fixation hook with binding wires to keep no contact with pipelines. Communication lines between indoor and outdoor units also should go along the right side plate and keep away from power lines.

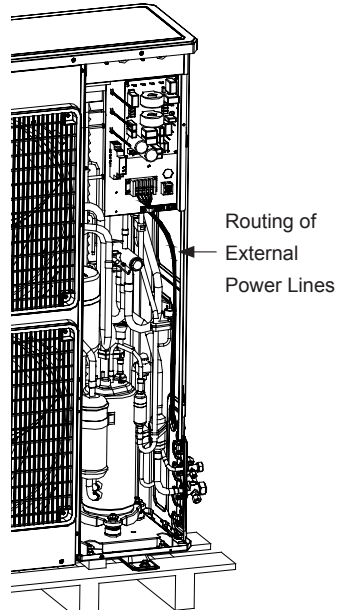

Fig.36

5 Installation of Controllers

Refer to the Installation Manual of the controller for more details.

6 Test Running

6.1 Trial Operation and Testing

(1). The meaning of error codes as shown below:

Table 10

Number	Error code	Error	Remarks
1	E1	Compressor high pressure protection	
2	E2	Indoor anti-freeze protection	
3	E3	Compressor low pressure protection, refrigerant lack protection and refrigerant collecting mode	

DC Inverter U-match Series Floor Ceiling Type Unit

4	E4	Compressor high discharge temperature protection	
5	E6	Communication error	
6	E8	Indoor fan motor error	
7	E9	Full water protection	
8	F0	Indoor ambient temperature sensor error	
9	F1	Evaporator temperature sensor error	
10	F2	Condenser temperature sensor error	
11	F3	Outdoor ambient temperature sensor error	
12	F4	Discharge temperature sensor error	
13	F5	Temperature sensor error of wired controller	
15	C5	Capacity code error	
16	EE	Outdoor memory chip error	
17	PF	Electric box sensor error	
18	H3	Compressor overload protection	
19	H4	Overloading	
20	H5	IPM protection	
21	H6	DC fan motor error	
22	H7	Drive desynchronizing protection	
23	Hc	Pfc protection	
25	Lc	Activation failure	
26	Ld	Compressor phase sequence protection	
27	LE	Compressor stalling protection	
28	LF	Power protection	
29	Lp	Indoor and outdoor mismatch	
30	U7	4-way valve direction changing protection	
31	P0	Drive reset protection	
32	P5	Over-current protection	
33	P6	Communication error between main control and drive	
34	P7	Drive module sensor error	
35	P8	Drive module over temperature protection	
36	P9	Zero passage protection	
37	PA	AC current protection	
38	Pc	Drive current error	
39	Pd	Sensor connecting protection	
40	PE	Temperature drift protection	
41	PL	Bus low voltage protection	
42	PH	Bus high voltage protection	
43	PU	Charge loop error	
44	PP	Input voltage abnormality	
45	ee	Drive memory chip error	

Note: When the unit is connected with the wired controller, the error code will be simultaneously shown on it.

(2). Instructions to the Error Indicating Lamps on the Panel of the Floor Ceiling Type Unit.

States of the Indicating Lamps:

- ① . Indicating Lamp of “POWER”: The indicating lamp will shine when power on, while it will go out when power off.
- ② . Indicating Lamp of “COOL” :
The indicating lamp will shine when “COOL” is activated, while it will go out when “COOL” is deactivated.
- ③ . Indicating Lamp of “HEAT”:
The indicating lamp will shine when “HEAT” is activated, while it will go out when “HEAT” is deactivated.
- ④ . Indicating Lamp of “TIMER”:
The indicating lamp will shine when “TIMER” is activated, while it will go out when “TIMER” is deactivated or the set.

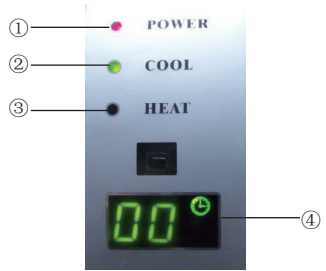

Fig.37

6.2 Working Temperature Range

Table 11

Test Condition	Indoor Side		Outdoor Side	
	DB(°C)	WB(°C)	DB(°C)	WB(°C)
Nominal Cooling	27	19	35	24
Nominal Heating	20	–	7	6
Rated Cooling	32	23	48	–
Low Temp. Cooling	21	15	-15	–
Rated Heating	27	–	24	18
Low Temp. Heating	20	–	-10	-11

Note:

- ① . The design of this unit conforms to the requirements of EN14511 standard.
- ② . The air volume is measured at the relevant standard external static pressure.
- ③ . Cooling (heating) capacity stated above is measured under nominal working conditions corresponding to standard external static pressure. The parameters are subject to change with the improvement of products, in which case the values on nameplate shall prevail.
- ④ . In this table, there are two outside DB values under the low temp cooling conditions, and the one in the brackets is for the unit which can operate at extreme low temperature.

7. Troubleshooting and Maintenance

7.1 Troubleshooting

If your air-conditioning unit suffers from abnormal operation or failure, please first check the following points before repair:

Table 12

Failure	Possible Reasons
The unit cannot be started.	<ul style="list-style-type: none"> ① . The power supply is not connected. ② . Electrical leakage of air-conditioning unit causes tripping of the leakage switch. ③ . The operating keys are locked. ④ . The control loop has failure.
The unit operates for a while and then stops.	<ul style="list-style-type: none"> ① . There is obstacle in front of the condenser. ② . The control loop is abnormal. ③ . Cooling operation is selected when the outdoor ambient temperature is above 48°C.
Poor cooling effect.	<ul style="list-style-type: none"> ① . The air filter is dirty or blocked. ② . There is heat source or too many people inside the room. ③ . The door or window is open. ④ . There is obstacle at the air intake or outlet. ⑤ . The set temperature is too high. ⑥ . There is refrigerant leakage. ⑦ . The performance of room temperature sensor becomes worse
Poor heating effect	<ul style="list-style-type: none"> ① . The air filter is dirty or blocked. ② . The door or window is not firmly closed. ③ . The set room temperature is too low. ④ . There is refrigerant leakage. ⑤ . The outdoor ambient temperature is lower than -5°C. ⑥ . Control loop is abnormal.

Note: After carrying out the check of the above items and taking relevant measures to solve the problems found but the air-conditioning unit still does not function well, please stop the operation of the unit immediately and contact the local service agency designated by Gree. Only ask professional serviceman to check and repair the unit.

7.2 Routine Maintenance



WARNING !

- ① . Do not turn off the unit and cut off the main power supply when cleaning the air conditioner, otherwise electric shock may happen.
- ② . Do not make the air conditioner wet or electric shock may be lead; Ensure that the air conditioner will not be cleaned by water rinsing under any circumstance.
- ③ . Volatile liquid like thinner or gasoline would damage the appearance of air conditioner. (So, only soft dry cloth and wet cloth moistened by neutral cleaning fluid could be used to clean the surface panel of air conditioner.)

(1). Disassembly method of filter screen and electric box cover

<p>1. Open the air inlet grille</p> <ul style="list-style-type: none"> ① . Firstly unfix two buckles on the grille as shown on the picture. ② . Remove the screws under the buckles by a screwdriver and then open the inlet grille. 	<p style="text-align: center;">Remove the screw</p>
<p>2. Clean the filter screen</p> <p>Clean the filter screen by a vacuum cleaner or wash it by flashing water. If the oil stain on the filter can not be removed or cleaned up, wash it by warm water mixed with the detergent. Dry the filter in the shadow.</p> <p>Note:</p> <ul style="list-style-type: none"> ① . Never use hot water over 45°C in case of color fading or turning yellow. ② . Never dry it by fire so as to prevent the filter caught fire or deformation. 	
<p>3. Disassemble the left and right side board</p> <ul style="list-style-type: none"> ① . After the grille is removed, use a screwdriver to remove the screws shown on the picture. ② . Push the side plate as per the arrowed direction and take it down. 	<p style="text-align: center;">Remove the screw</p>
<p>4. Disassemble the right side board</p>	<p>Disassembly method of right side board Step 3</p>

5. Disassemble the electric box cover
After the right side board is removed, the electric box cover will be shown up and disassemble the fixed screws on it.

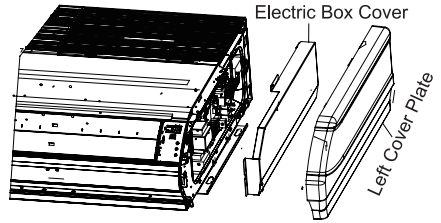

(2). At the Start of the Seasonal Use

- 1) Check if there is blockage at the inlet or outlet vent of air conditioner.
- 2) Check if the earth wire has been attached reliably by the skilled serviceman.
- 3) Check if the exhausted batteries of the wireless controller have been replaced.
- 4) Check if the air filter had been installed well by professional.

Keep the power switch "On" 8 hours before the startup of the unit which has not been used for a long period.

Note: all above should be operated by the skilled serviceman.

(3). At the End of the Seasonal Use

- 1) Cut off the power supply main switch
- 2) Clean the air filters and other parts by the skilled serviceman.
- 3) Leave the fan running for 2-3 hours to dry the inside of the unit.

Note: all above should be operated by the skilled serviceman.

GREE ELECTRIC APPLIANCES, INC. OF ZHUHAI

Add: West Jinji Rd, Qianshan, Zhuhai, Guangdong, China, 519070
Tel: (+86-756) 8522218 Fax: (+86-756) 8669426
E-mail: gree@gree.com.cn www.gree.com



66179400012